

# LIVING n o w



#ImprovingLives

**bticino**

A brand of **legrand**



LIVING  
**n o w**



**bticino**



# Contents

	DESIGN		INSTALLATION
<b>8</b>	New "metallic effect" collection	<b>46</b>	Standard installation
<b>10</b>	Control device customisation	<b>48</b>	InWall installation
<b>12</b>	Monochromatism	<b>52</b>	Quick guide to choosing the most suitable solution for your project
<b>14</b>	Cover plate finishes		
<b>16</b>	Flush mounted installation		CATALOGUE
<b>18</b>	Iconic full touch controls	<b>54</b>	Switches, sockets and functions for the traditional electric system
<b>19</b>	Different ergonomics	<b>88</b>	Living Now with Netatmo: smart radio controls.
<b>20</b>	Solutions for an always perfect installation	<b>116</b>	Living Now MyHOME: Bticino SCS BUS controls
	SMART HOME TECHNOLOGIES	<b>134</b>	Living Now KNX: KNX BUS controls
<b>22</b>	One finish, many technologies	<b>143</b>	Range of cover plates, boxes, supports and accessories
<b>23</b>	The right technology for every system		
<b>24</b>	Guide to choosing the technology for your project	<b>164</b>	DIMENSIONAL DATA
<b>26</b>	Home + Control. One single app, many connected advantages		
<b>27</b>	Voice commands, everything at your fingertips		
<b>28</b>	New Home + Pro app		
<b>30</b>	Home + Project App		
<b>32</b>	Smart electric system		
<b>36</b>	MyHOME BUS home automation system		
<b>40</b>	KNX BUS home automation system		
<b>44</b>	UXOne		



# LIVING now

Living Now evolves to meet the new demands of contemporary living, combining exclusive design, technology and a valuable user experience.



Living Now allows to create traditional, smart and home automation systems with the same flexibility, expanding the possibilities of customisation and always guaranteeing reliable and consistent results with each project.

# New monochrome collection

Living Now expands its range with three new high-value finishes:  
Bronze, Champagne and Steel.

Cover plates and key covers with the same colour tone ensure an essential and distinctive metallic monochrome effect throughout the whole system.

A choice that makes it possible to offer a completed wiring device assembly with a refined visual impact, combining functionality and aesthetics to enhance each project with finishes that deliver superior value.

Steel: contemporary reflections



## Bronze, Champagne and Steel: new finishes to add value to every project

The new Living Now finishes are designed to suit different styles: Champagne offers a **warm glow**, Bronze conveys an aged **charm**, while Steel introduces **contemporary reflections** suited to more modern environments. The new design of the cover lens, now even thinner, more discreet and more elegant than those of the traditional finishes, is a true sign of style.

Bronze: ancient appeal

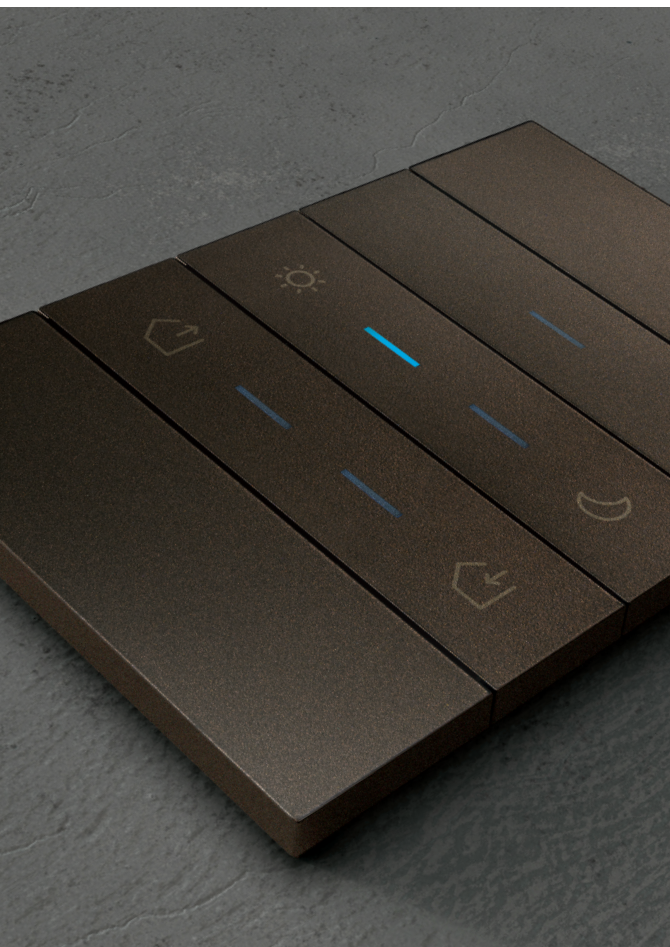

Champagne: warm luminosity



# Control device customisation

With the new Living Now metallic covers - Champagne, Bronze and Steel - it is possible to create tailor-made electric systems with custom symbols and texts that fully meet the individual needs of the customer.



### Make the system unique

The covers can be customised according to individual customer's needs, for a new user experience and a system that is truly unique.

Thanks to the new dedicated configurator - the "MySwitch configurator" -, the possibilities become endless, from the selection of pictograms from an extensive gallery, to the application of customised symbols or lettering. It is also possible to set the backlighting of devices for easy identification in the dark or to monitor the status of the load.

### Full product images

In addition to the possibility of completely customised covers, with the "MySwitch configurator" the devices in the Living Now catalogue can be combined to create a completed wiring device assembly with the desired functions. It is possible to download a realistic image of the resulting configurations, together with a list of the materials required for their realisation.

This tool is an effective support for end users, designers and installers, allowing them to preview the appearance of each completed wiring device assembly in the installation.

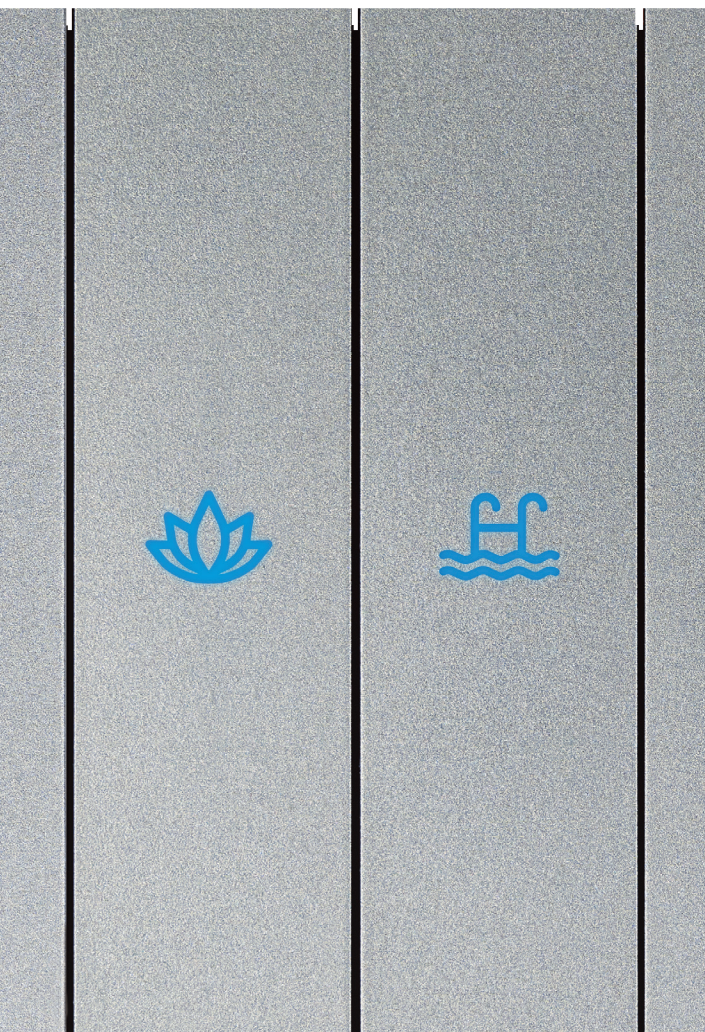

Note: MySwitch configurator is available at the following address: [myswitchconfigurator.bticino.com](https://myswitchconfigurator.bticino.com)

# Monochromatism

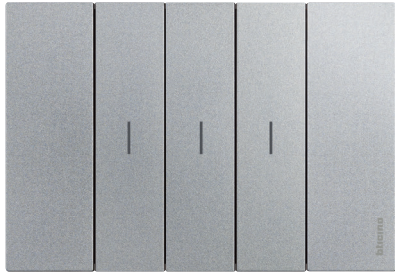

Steel



Champagne



Bronze



The new Steel, Champagne and Bronze metallic effects further enhance the existing white, sand and black finishes, offering higher value solutions suitable for contemporary environments and prestigious projects.



The choice of colours becomes a design tool: aesthetic continuity between cover plate and key covers makes it possible to offer a system that is perfectly integrated into any environment and architectural style.

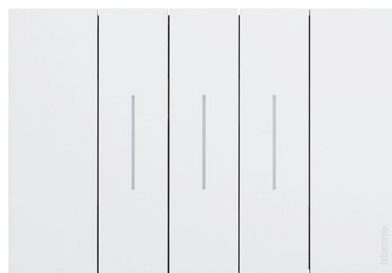

White



Sand

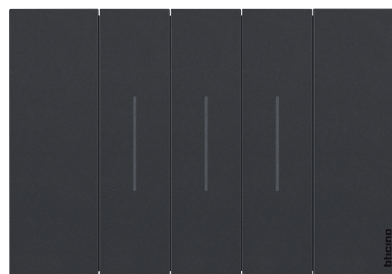

Black

# A refined selection of finishes

The Living Now cover plate range includes a total of 15 finishes, carefully selected to be matched with the colour of the covers.

The cover plates are made of **technopolymer, zamak and wood**.  
A thoughtful selection of materials to meet customer needs.



**CHAMPAGNE  
cover plate**  
Material: zamak  
Code...KC



**STEEL  
cover plate**  
Material: zamak  
Code...KS



**BRONZE  
cover plate**  
Material: zamak  
Code...KB



**WHITE  
cover plate**  
Material:  
technopolymer  
Code...KW



**SAND  
cover plate**  
Material:  
technopolymer  
Code...KM

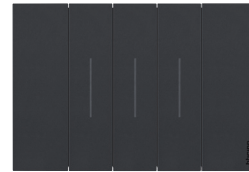

**BLACK  
cover plate**  
Material:  
technopolymer  
Code...KG



**ICE  
cover plate**  
Material:  
technopolymer  
Code...DW

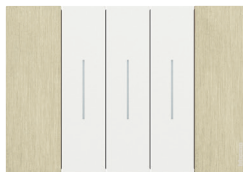

**GOLD  
cover plate**  
Material: zamak  
Code...ZW



**NIGHT  
cover plate**  
Material:  
technopolymer  
Code...DG

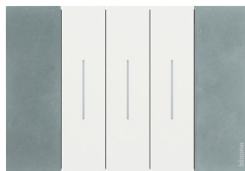

**MOON  
cover plate**  
Material: zamak  
Code...NW



**BRUSHED STEEL  
cover plate**  
Material: zamak  
Code...ZG

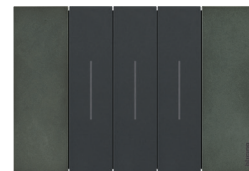

**SPACE  
cover plate**  
Material: zamak  
Code...NG



**COPPER  
cover plate**  
Material: zamak  
Code...ZM



**OAK  
cover plate**  
Material: wood  
Code...LM



**WALNUT  
cover plate**  
Material: wood  
Code...LG

# Finishes of the devices

The devices feature an aesthetic component, the covers, available in six finishes. The already existing white, sand and black shades are now joined by new metallic variants: Steel, Champagne and Bronze.

Satin finish surface.

**Classic:** in white, sand and black colour, with standard backlight lens.



White



Sand



Black

**New:** featuring the same metallic finish as the new cover plates and a more discreet backlight lens than the classic versions.



Steel



Champagne



Bronze



# InWall installation

New architectural solution for a full flush integration of the electric system.

The solution meets the needs of those who seek essential, uncluttered and visually harmonious environments without compromising on functionality.

The InWall installation is easy on any type of wall, whether masonry or plasterboard, thanks to special accessories and the use of standard boxes (items 503E, 504E...).

Fully compatible with all Living Now finishes and all BTicino technologies, from traditional to smart home and home automation systems, to the junction boxes.



Junction box



Living Now won the iF Design Award in 2019; in 2026, the award was also given to the Living Now InWall solution, confirming BTicino's ability to combine technology and design.



Composition with controls

# Iconic full touch controls

Full touch controls are one of the main features of Living Now.

The light is switched on and off by pressing anywhere on the surface of the key, which automatically returns to its initial position after operation, perfectly aligned at all times.

## Backlit

Backlighting (optional) makes it easy to locate the control devices even in the dark.



## Customisable

The new covers are fully customisable, offering the possibility of adapting the control to the style of the customer and to project requirements.



# Advanced ergonomics

In the standard system, in addition to traditional controls, Living Now offers new opportunities.

## Traditional control: axial full touch

Designed for maximum elegance, axial control keeps mechanisms, covers and cover plates perfectly aligned at all times.



## Touchless controls

Thanks to these new highly sensitive controls, it is sufficient to bring your hand close to the product - without actually touching the surface - to turn the light on or off, also ensuring a high level of hygiene in the controls themselves.

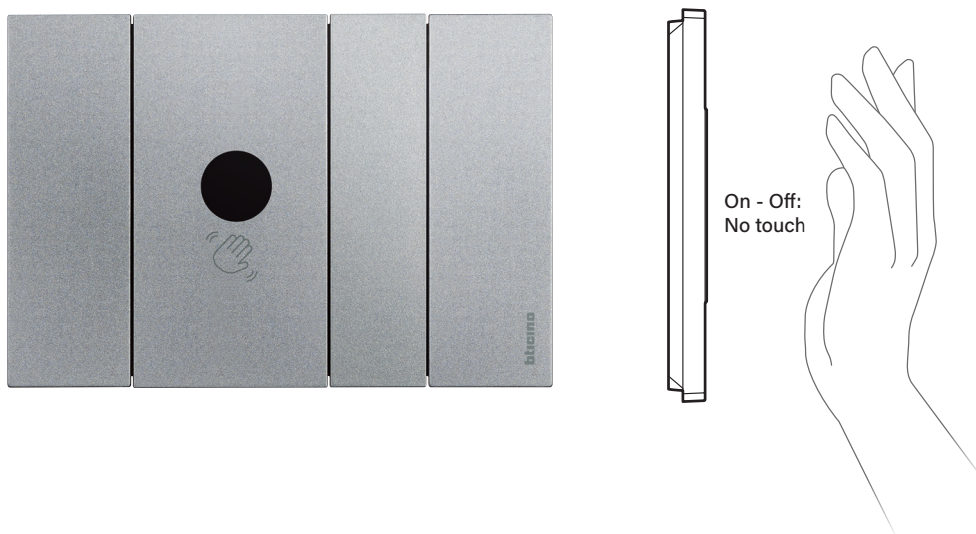

# Solutions for an always perfect installation

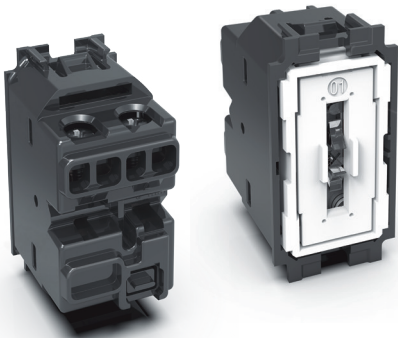

## Full touch control: electro mechanics

- 1) tested with over 80,000 activations with the load connected; double than the standard requirements. This equals over 40 years of "normal" use.
- 2) 10AX 250 V or 15AX 127 V, tested up to 700 A peak; also perfect for the new LED light bulbs, which generate significant peak current when switched on.

## Self centering system

Questo sistema di autocentratura delle cover è brevettato e permette alle cover dei comandi di restare sempre allineate agli altri componenti del punto luce, anche dopo molteplici azionamenti.

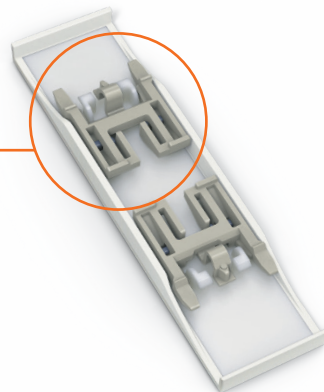

## Floating frame

It's the flexible floating frame at the back of the cover plate that makes sure that the light point perfectly adheres to any wall.

The floating frame gives the possibility of:

- 1) hiding wall defects;
- 2) hiding any irregularity in flush mounted boxes their positioning;
- 3) hiding the external collars of plasterboard boxes.



## Stronger support

Up to 4 times stronger than the current version, thanks to the new geometry and high performance materials.



## Better protection

The support has a protective shell, which can be used to protect supports and mechanisms from possible damage during decorating activities, for example when painting the walls.

# One finish, many technologies

In addition to the traditional electric system, Living Now also allows the creation of smart and home automation systems with the same finishes.

Thanks to advanced devices, it will be possible to enjoy functions that are not available with traditional systems, to guarantee comfort, energy efficiency and safety in all architectural contexts, from the residential sector to the small tertiary and hotel sector, managed by the user through local controls, using the Home + Control app or with Alexa, Google and Siri voice commands.



# The right technology for every system

Living Now has the most suitable technology for every user need and building type. In addition to classic systems based on traditional devices, it is also possible to install Smart Home systems with devices connected via radio and BUS-based home automation systems.

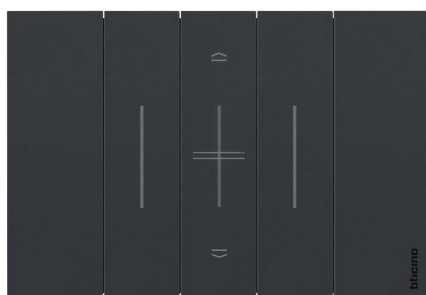

Living Now with Netatmo

Connected smart home devices that communicate via radio. Quick and easy configuration and operation. Perfect for both new installations and renovations.

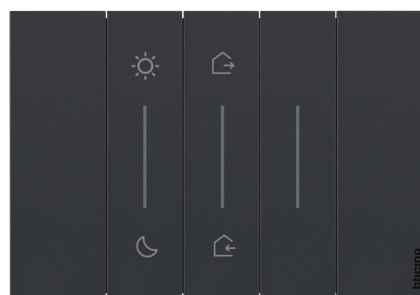

Living Now MyHOME

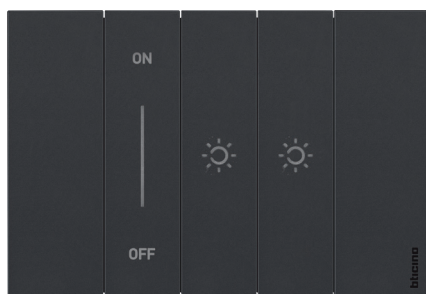

Connected devices for Home automation, communicating via the BTicino's SCS BUS. Perfect for new and large systems. Endless function customisation possibilities.



Living Now KNX

Connected controls for home and building automation in homes and professional facilities communicating via KNX standard BUS. Perfect for any requirement. Full integration with different systems.

# Guide to choosing the technology for your project

	Traditional system	Zigbee radio system
		
<b>TYPICAL FUNCTIONS</b>	On/Off and dimming of lights, sockets, basic UP/DOWN shutter control, basic temperature control.	In addition to the traditional system functions: <ul style="list-style-type: none"> <li>• Management of automations and smart scenarios</li> <li>• Smart zone temperature control (1 for each thermostat)</li> <li>• General control</li> <li>• Management of anti-blackout energy</li> <li>• Measurement of consumed energy</li> </ul>
<b>CHOOSE THE TECHNOLOGY IF THE PROJECT IS FOR...</b>	A simple installation, without automation	A house to be made smart without masonry work
<b>LOCAL FUNCTION CONTROL MODE</b>	Using traditional control devices (switches, diverters, inverters, dimmers,...)	Using: <ul style="list-style-type: none"> <li>• traditional control devices</li> <li>• Smart connected control devices, even wireless</li> <li>• Smartphone with Home + Control app</li> </ul>
<b>VOICE FUNCTION CONTROL</b>	Not possible	With Google, Alexa and Siri assistants
<b>REMOTE FUNCTION CONTROL MODE</b>	Not possible	Using a Smartphone with Home + Control app and Home + Security app (if the system includes gas, smoke and CO <sup>2</sup> detectors, and Netatmo cameras)
<b>COMPLEXITY AND PERFORMANCE</b>	Low (standard functions)	Medium (smart lighting, shutter and energy management)
<b>WIRING</b>	With standard phase and neutral cables for control devices, lamps, sockets, etc.	Like a traditional system - neutral cable for connected devices and installation of appropriate WiFi gateway required
<b>WHERE TO USE IT</b>	Standard residential environments	Standard residential environments
<b>WHEN TO USE IT</b>	For new systems or renovations	For new systems and renovations (ideal for adding smart functions and devices without the need for masonry work)
<b>SCALABILITY (READINESS FOR NEW FUNCTIONS)</b>	Low, due to the complexity of the interventions to the existing plant	Medium, due to system expansion and addition of new functions (scenario, general control) using radio devices
<b>FUNCTION CONFIGURATION</b>	Not required	- With Home + Pro app, even offline without Wi-Fi connection. - With Home + Control app with Wi-Fi connection (for a more advanced configuration)
<b>TECHNICAL PROFILE OF THE INSTALLER</b>	Basic	Basic/medium. Knowledge of the configuration of Smart devices with the Home + Pro app (offline configuration) or the Home + Control app (online configuration)
<b>SYSTEM VALUE</b>	€	€ €

### MyHOME bus system

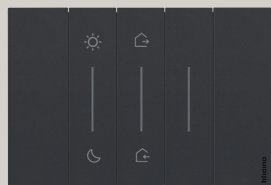

### KNX bus system

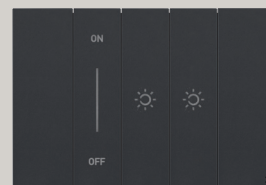

- In addition to the Smart system functions:
- Scenario management based on conditions (weather, time, system status, etc.)
  - Automatic activation of lights and shutters triggered by burglar alarm events
  - Zone temperature control (max. 99) with system-integrated humidity management
  - Management of DALI2 lighting

A multi-storey house or one with advanced functions

- Using:
- home automation control devices
  - video door entry system for function control: Hometouch or Classe 300EOS
  - Smartphone with Home + Control app

With Google and Alexa assistants

Using a Smartphone with Home + Control app and Home + Security (if the system includes BTicino video door entry systems and burglar alarm systems)

High (integrated solutions, including third-party solutions, for comfort safety and energy saving)

BUS-specific with dedicated cable, 2-core non polarised, power supply and server

Extended, multi-storey residential environments

For new systems or significant renovations - requires BUS wiring

High, thanks to integration with BTicino video door entry systems and the modification of the current functions by adding and/or reconfiguring devices.

With the specific Home + Project app

Medium/high. Knowledge of the configuration of MyHome devices with the Home + Project app



- In addition to the MyHome system functions:
- RGB/RGBW lighting control with presence and brightness sensors ON/OFF, dimming (DALI-2, 1-10V) and scenes,
  - Multi-zone HVAC: FCU, VRV/VRF, setpoint and fan speed control
  - Energy metering and consumption monitoring per zone
  - Full BMS integration via IP/KNX router
  - Access control, burglar alarm and third-party system integration

A commercial, hospitality or large residential building requiring open standard, multi-brand integration and long-term scalability

- Using:
- Home automation control devices KNX secure certified
  - Touch screens
  - Other solutions based on integrated third-party products/systems

Compatible with Google Home, Amazon Alexa and other voice assistants compatible third-party integration

Compatible with any remote control app or any BMS, SCADA or supervision platform linking KNX networks

Very high. KNX certified devices, programmed via ETS software. Designed for demanding projects requiring energy saving, flexibility and long term interoperability.

BUS-specific with standard KNX dedicated cable (2 or 4 conductors) with KNX power supply

Commercial buildings, hotels, hospitals, airports, large residential, any project requiring open protocol and multi-system integration

For new systems or major renovations - requires BUS wiring + planning or project specified by engineering consultant

Very high integration capability with third-party systems and a wide range of devices, thanks to the KNX open standard (ISO 14543). Full reconfigurability and expandability without system replacement

With ETS-licensed software. Configuration done by any certified KNX Partner

High. Knowledge of the KNX offer and the ETS software for the configuration of the devices (KNX Partner certification strongly recommended)





# Home + Control. One single app, many connected advantages

With the Home + Control app, irrespective of the chosen technology, Smart or BUS, the user can easily manage all the home functions locally or remotely using iOS/Android smartphones.

## What the user can do

1. Activate and customise **8 default scenarios** (4 preconfigured scenarios, coming in, going out, day, night and 4 scenarios customisable by the user) and create new ones;

2. Display and check the status of lights, shutters, loads connected to sockets and the room temperature;

3. Use the temperature control system in a simple and intuitive manner;

4. Check the total home consumptions;

5. Display the production of the photovoltaic system;

6. Receive notifications on the load and system status;

7. Define the load priority for black-out prevention.

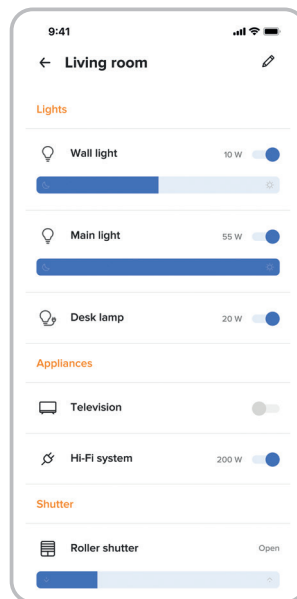

Lights, shutters and loads activation

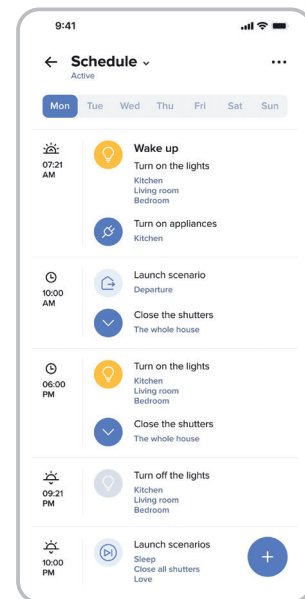

Consumption display

# Voice commands, everything at your fingertips

The systems, connected via radio or to the MyHOME BUS, can also be managed by voice thanks to a special MyHOME Voice Command system with integrated Amazon Alexa assistant, or with third-party devices such as Apple, Google and Amazon voice assistants. An extremely useful function, also for those with mobility problems.



MyHOME voice command

If the Smart Home bus system is integrated with a video door entry system with Classe 300EOS internal unit, the latter can also be used to manage all the functions using the natively integrated Alexa voice assistant.



**Alexa,  
switch the kitchen  
lights on**



# New Home + Pro app

Easy and quick configuration of the connected Smart system, without the need for internet connection

Specifically designed for installers, the Home+Pro app is the new professional tool that allows for the configuration of With Netatmo smart electrical system even without an Internet connectivity, making every installation faster and more efficient.

## Benefits

Offline operational flexibility



Ability to work even in areas without connectivity (e.g. construction sites).

Ease of use and maximum efficiency



Fast configuration and reduced installation time.

Intuitive interface

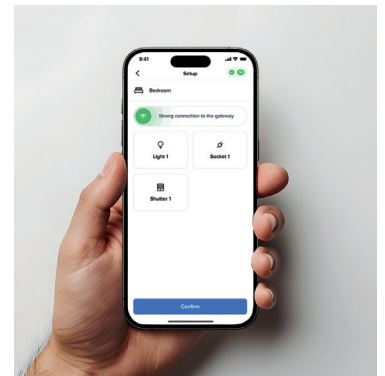

The configuration quality and experience improve without changing working habits.

## Integrated smart ecosystem

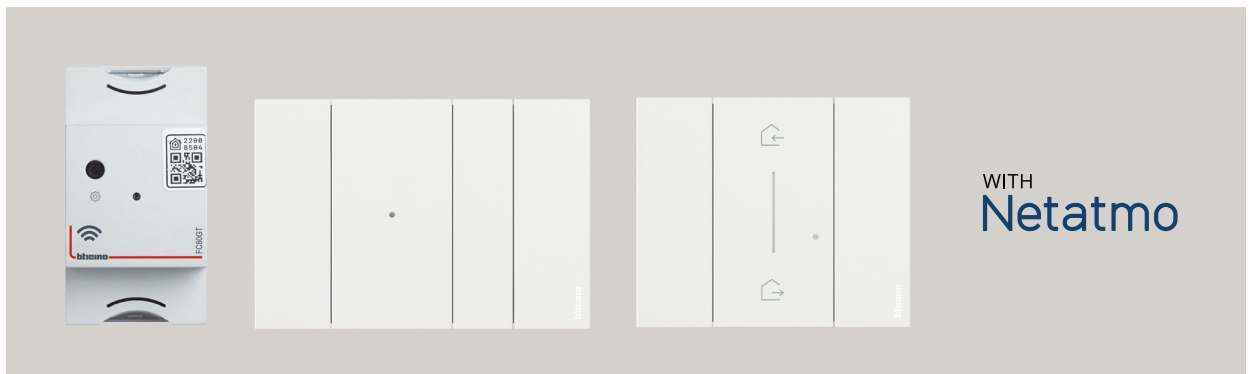

Compatibility with the Smart product ecosystem based on Zigbee technology, including interfacing and operation through the Home + Control app.

## Example of offline configuration

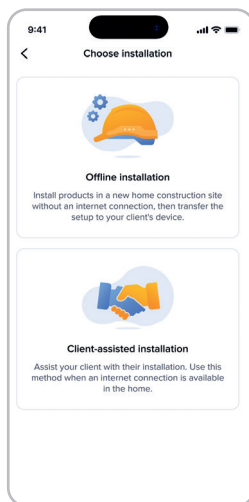

1. Select the type of installation



2. Direct connection to the Gateway

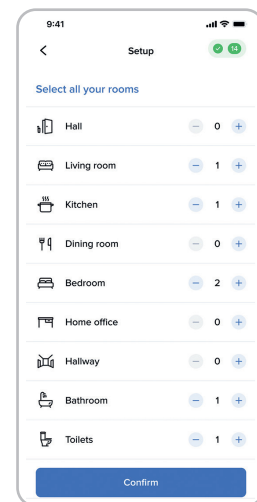

3. Automatic product search and room customisation

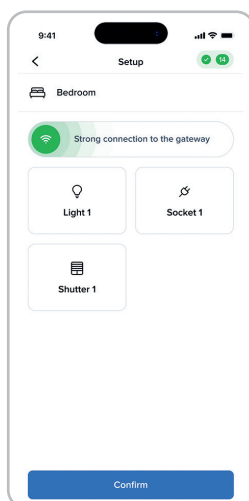

4. Placement of the products in the rooms

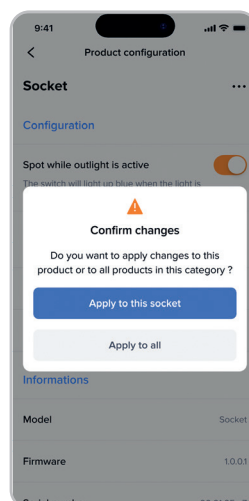

5. Configuration and validation of the device settings.



Home + Control

The configuration stored in the gateway will be fully available when the user registers the system on the Home + Control app, allowing the user to manage all the functions, even remotely.

# Home + Project App

Configuration of the MyHOME system in the office or on site and without Internet.

Home + Project is the work tool for the installer for designing and configuring MyHOME BUS home automation systems and LINEA5000 video door entry systems. It is available in 2 versions: a web app version for office-based design using a desktop PC, and a mobile app for iOS and Android devices to complete the configuration on site.

Regardless of the server model installed in the system, DIN Server item F460 or Classe 300EOS internal unit, the design and configuration experience will be the same: simple and intuitive.

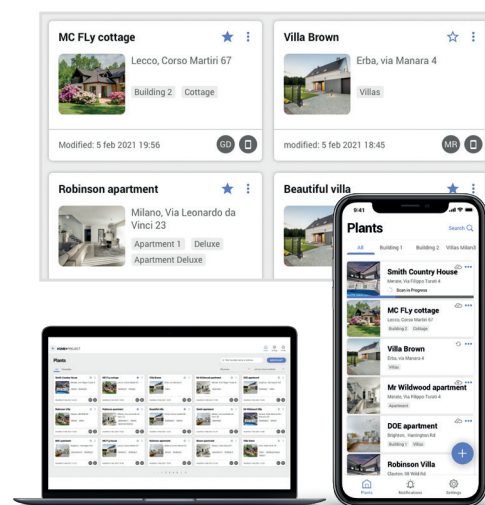

## Configuration Steps

### 1. System design.

Create, both in the office or on site, the project with the list of rooms and objects.

### 2. Configure the system on site.

Connect the app to the system through the web server local Wi-Fi and start the configuration process.

### 3. Deliver the system to the user.

Once the configuration has been completed, the system is ready.

The user only needs to download the Home+Control and the Home+Security Apps to start managing their home in an easy and smart way.

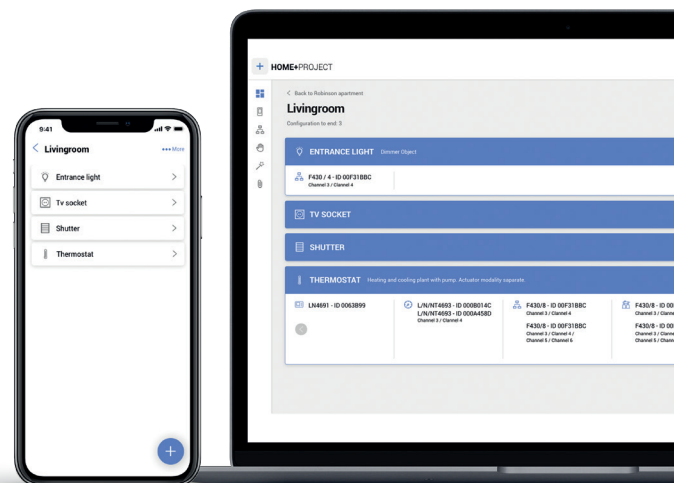

## Example of configuration of a DALI2 dimmer actuator

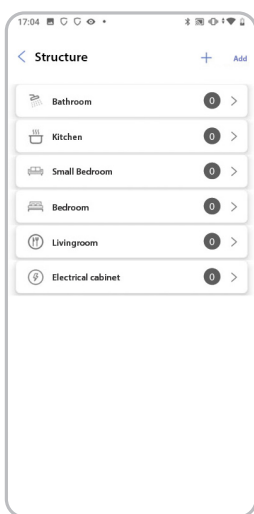

1. Choose the room to which to associate the dimmer

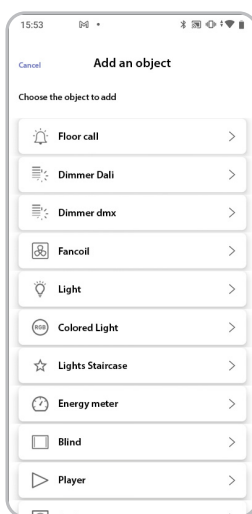

2. Select the device to be configured

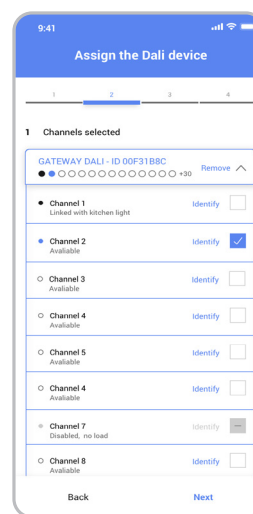

3. Select the actuator to be configured



4. Associate the control device with the actuator

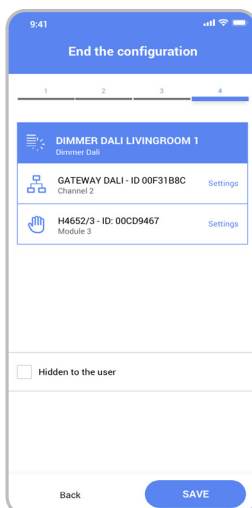

5. After the configuration has been completed, the app shows the association between the DALI 2 actuator and the respective control device in the selected room.



Home + Control

The configuration stored in the gateway will be available upon registration of the system on the Home + Control app by the user, who will be able to manage all the functions, also remotely.

# With Netatmo smart electrical system

The Smart home, simple and safe.

Living Now makes it possible to install a new system or transform an existing one by adding connected smart functions through smart devices, wired like traditional devices and connected to the home Wi-Fi network through a special gateway.

All comfort, energy-saving and safety functions are managed by the user via local controls, using the **Home + Control** app, or by voice with the **Alexa, Google and Siri** voice assistants.

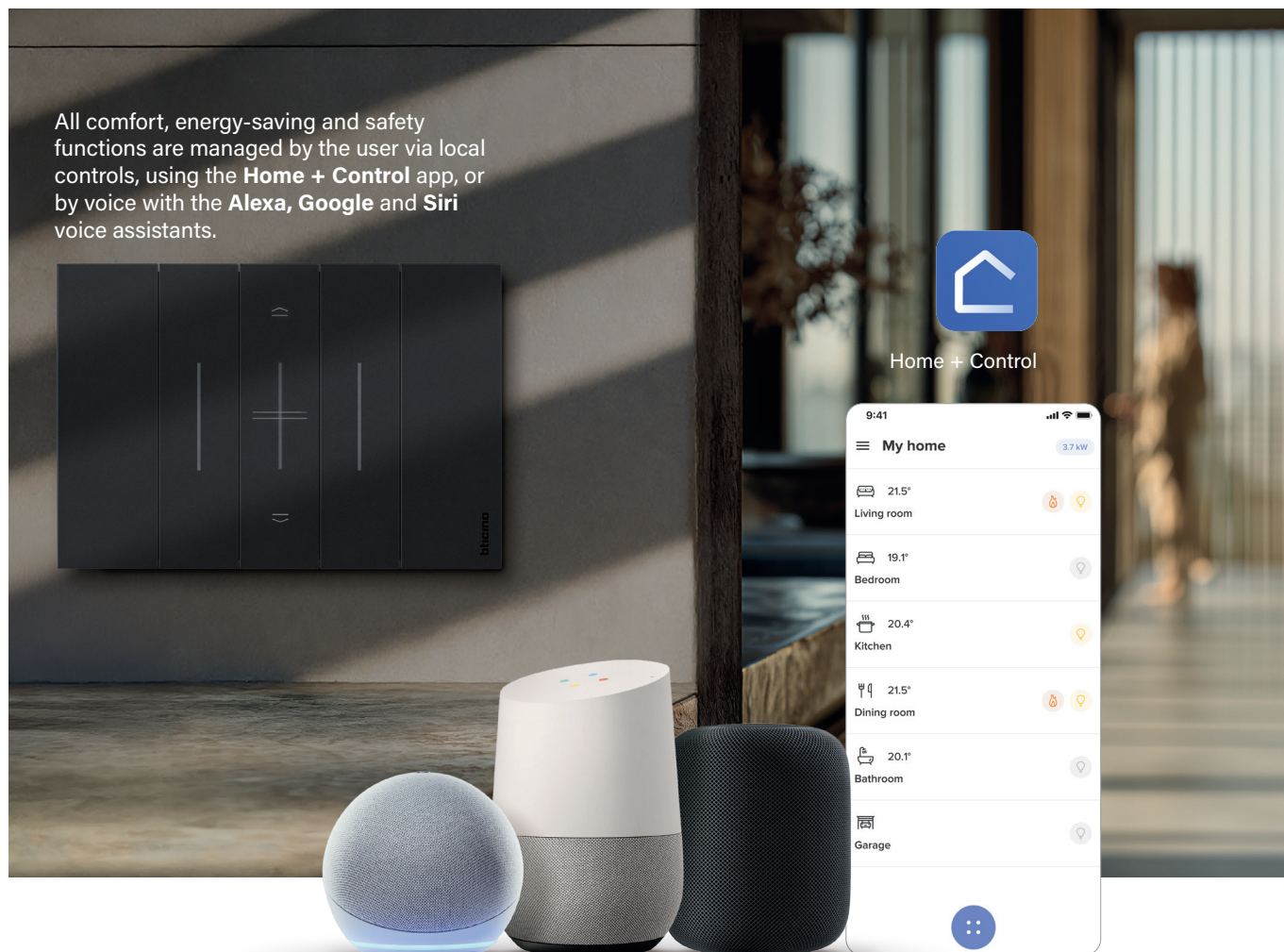

The image displays a Netatmo smart electrical system. On the left, a dark grey control panel with five vertical slots is mounted on a wall. In the foreground, three smart speakers are shown: a small blue one, a white one with a grey base, and a black one. On the right, a smartphone screen shows the 'Home + Control' app interface. The app displays a list of rooms with their current temperatures and energy consumption:

Room	Temperature	Energy Consumption
Living room	21.5°	3.7 kW
Bedroom	19.1°	
Kitchen	20.4°	
Dining room	21.5°	
Bathroom	20.1°	
Garage		

## Same simplicity as always with many more Smart functions

Temperature management



Control and management of the room temperature using the Smarther2 connected thermostat or the new Smarther AC for air conditioning management.

Lighting at the desired level



Integration of ZigBee 3.0 RGB lamps into the system and management of light levels and hues through dedicated connected dimmers.

Scenario control and general control



One click turns off all the lights in the house, lowers all the shutters or activates the preferred scenario.

Wireless control



Depending on user's needs, the system can be expanded using wireless controls for the management of lights, sockets, shutters or scenarios.

Energy consumption control

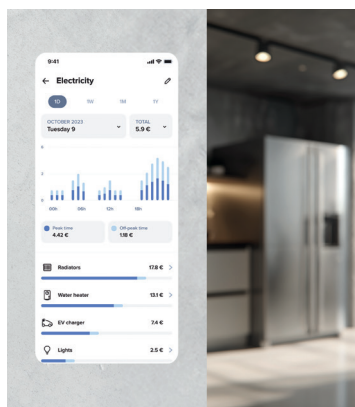

Effective real time energy consumption control. The system intervenes to prevent overload blackouts.

Schedule



Activation of lights, shutters and household functions according to user habits. The house adapts automatically, ensuring efficiency and well-being.

# With Netatmo smart electrical system

## Integration of new wireless sensors for comfort, energy efficiency and system safety

The integration of new wireless sensors in the Smart system allows monitoring of temperature, humidity, brightness, door and window openings, as well as water leakage, making the system even more advanced and reliable.

The use of these sensors allows the configuration of automatic smart scenarios, aimed at optimising comfort, safety and energy efficiency. At the same time, the user has greater control and customisation possibilities thanks to the Home + Control app, depending on the state of the home and environmental conditions.

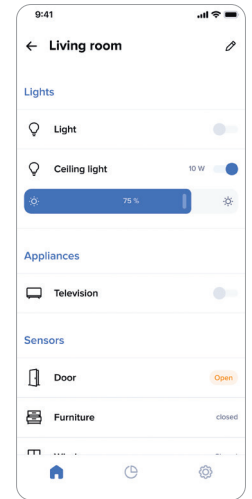

Status of the sensors in  
the Home + Control app

## Typical uses of sensors



Outdoor sensor, item 3588, for temperature  
and solar irradiation detection.



Water presence sensor, item 3590C.

## Smart comfort, all year round.

Using wireless sensors, the shutters move on their own according to environmental conditions such as temperature, humidity and solar irradiation, detected inside and outside the home. In summer, the shutters are lowered to protect against heat. In winter, they are raised to take advantage of natural light and maintain an ideal internal temperature.

The system works by exploiting automation, optimising comfort and energy efficiency in every season.

## Wireless outdoor controls.

For applications where greater protection from water, dust and external agents is required. Battery-free wireless controls with IP55 protection index can be integrated into the system to control lights, gates and garage doors.



# MyHOME BUS home automation system

MyHOME is an advanced BUS-based home automation system designed to offer advanced and flexible solutions in customised comfort, security and energy saving management.

Home automation functions are controlled by control devices with customisable silk-screen printing, touch screens, the dedicated Home + Control app, and Alexa and Google voice commands.

The system can be integrated with third-party systems and with the BTicino video door entry and burglar alarm systems.



## Freedom to choose the server you prefer

With MyHOME Server, you can choose the server best suited to your needs:

- DIN server, item F460, ideal for villas or complex systems; compatible with HOMETOUCH touch screens.
- Class300EOS internal unit with Alexa voice command, perfect for apartments and projects with integrated video door entry system.

A flexible choice to maximise the potential of the home automation system.

## The functions

### Lighting management



MyHOME is compatible with the DALI2 protocol for lighting management with ON/OFF controls, dimmers, RGB RGBW (colour and tunable white) and in and out fading, to create the ideal atmosphere for every need.

### Consumption measurement and load control

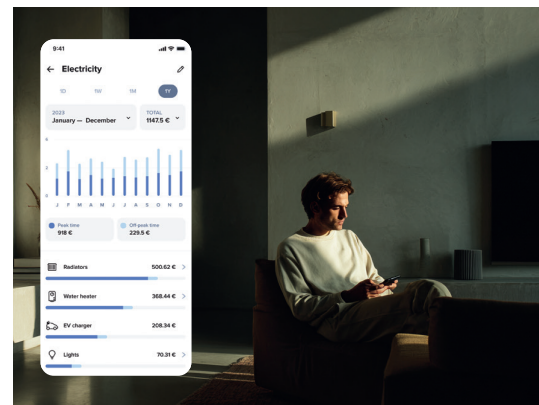

Display of data on electricity produced and consumed through the Home + Control app. Management of the maximum power used by the domestic electric system, to avoid overload blackouts.

### Automation of motorised shutters



UP and DOWN control with the possibility of storing the preferred position.

### Creation and management of scenarios



One click turns off all the lights in the house, lowers all the shutters and sets the desired temperature.

### Temperature management



Optimum comfort through the use of several thermostats around the house for zone-based management of temperature and humidity levels.

# MyHOME BUS home automation system

## New multifunction controls

Thanks to these new devices, it is possible to create flexible, high-level systems with which users can simplify the control of the functions according to their needs, optimising space. With a single 2-module size device, it is, in fact, now possible to manage up to 4 different functions that can be configured during the installation of the system in total flexibility with the HOME + PROJECT app.

In addition to these customisations, it will also be possible to fit the key covers with the desired icons and symbols using the MySwitch configurator.

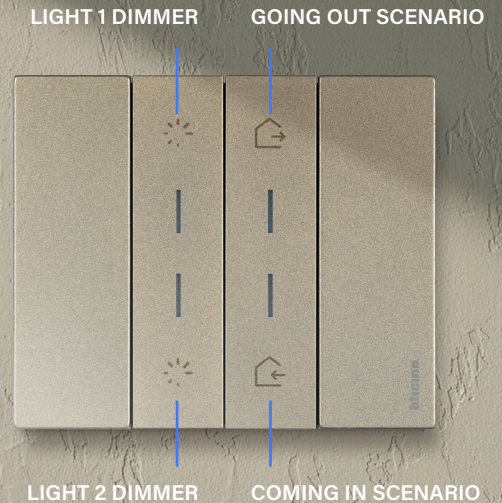

## Control configuration and function management

The configuration of the functions is completed with the Home + Project app, while management by the user is with the Home + Control app. In its most advanced version, this app is now capable of managing light units, allowing, for example, the simultaneous switching on of several lamps with a single click.



Home + Control

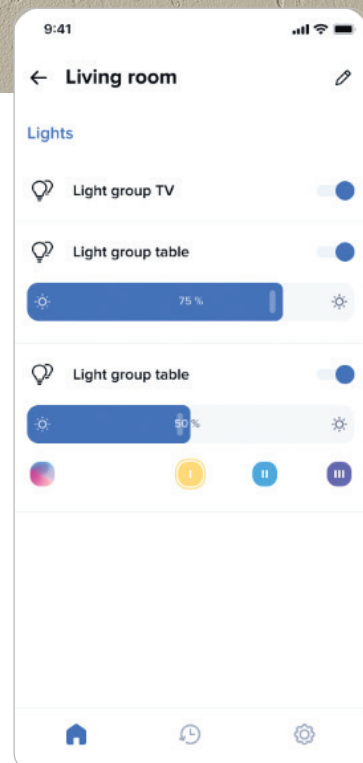

## Advanced DALI2 lighting management

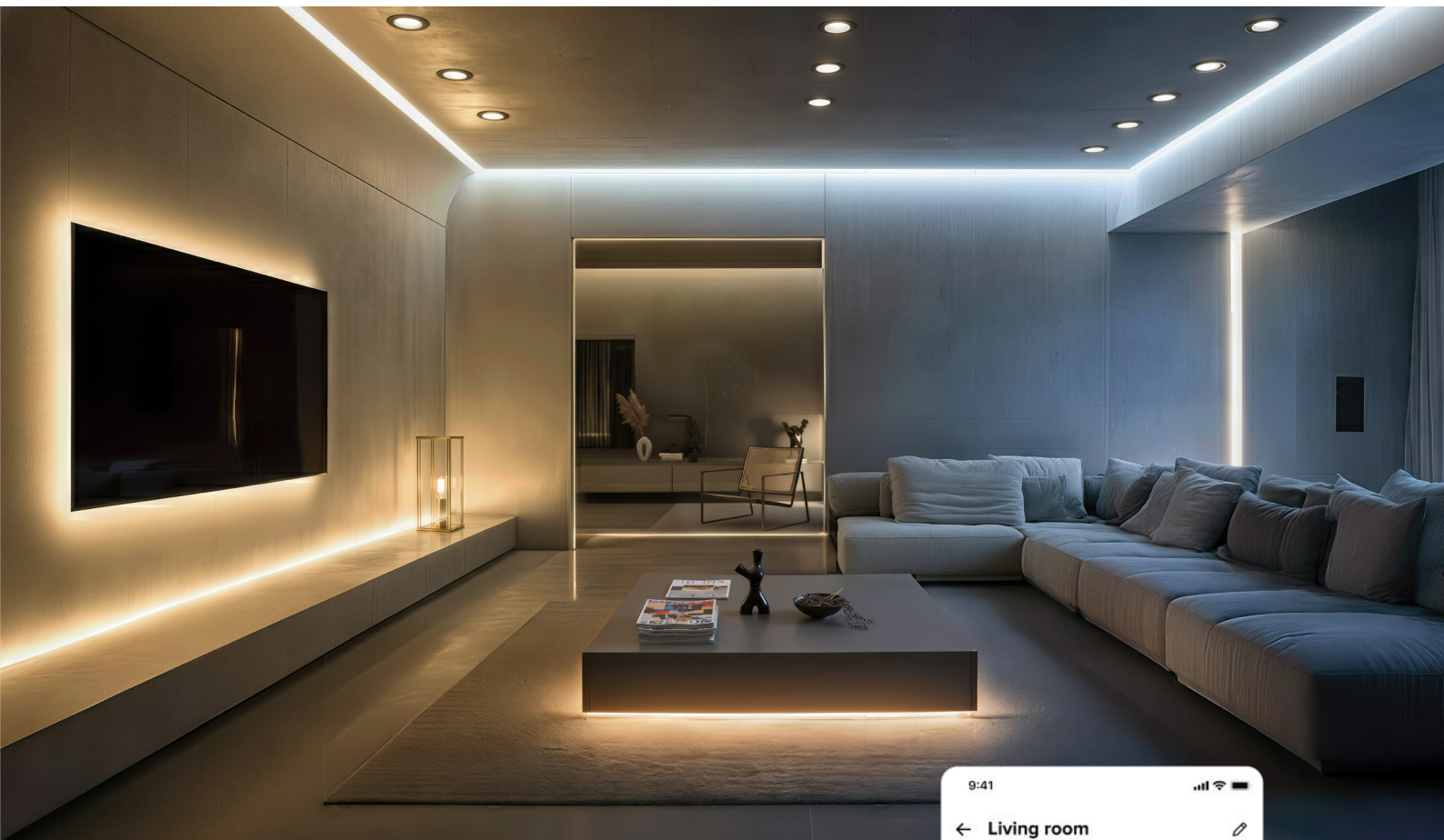

### Light to your liking

Another new feature introduced in MyHOME is the ability to manage DALI2 lighting groups through 'ambiences'!

Using a dedicated control, it is possible to configure and set different ambiances, each corresponding to different light intensities and color temperatures. By pressing and holding the control, the user can also quickly adjust the intensity of these ambiances. Through Home + Control, it is also possible to customize the configuration of each ambiance.

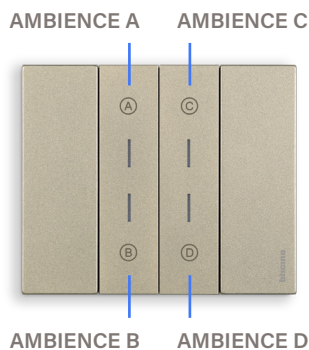

Home + Control

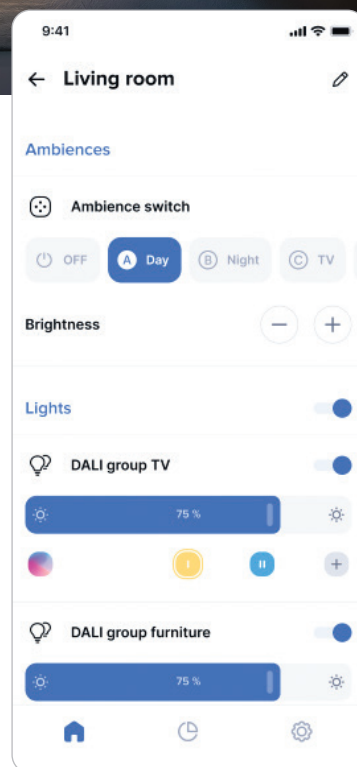

# KNX BUS home automation system

Connected controls communicating via KNX bus for advanced home automation in homes and professional facilities.



## Multifunction control.

Advanced device to be combined with the respective key covers with graphics, to manage up to 6 different channels (functions), which can be configured using the ETS software and modified at any time.

It is also possible to customise the key cover through the software MySwitch.

Dress KNX systems with Living Now and Living Now Premium finishes.

The Living Now device range is completed with a KNX-certified multifunctional control device that guarantees interoperability both among KNX products in the BTicino offering and among those of different manufacturers. This will make it possible to realise advanced solutions for the smart management of comfort and energy-saving functions in hotels, hospitals, the tertiary sector and residential buildings.



All devices comply with the KNX Secure protocol, which guarantees the protection of smart buildings with advanced encryption, preventing unauthorised access and cyber attacks for reliable systems and secure, uninterrupted operations.



## Home-automation functions

### Light control

Management of standard and coloured lamps with ON/OFF and dimmer functions for optimum comfort.

### Management of scenarios

Setting with just one touch of the lights, of the shutters and temperature to create comfort situations or prepare the environment for when it's not busy.



### Shutter management

UP/DOWN position control with storage of preferred position.



### Temperature management

Temperature control systems with ON-OFF and 1-10 valves and VRV/VRF cooling systems.

Setting of temperature, fan speed and control modes (off, antifreeze, etc.).



# KNX BUS home automation system

## The devices

### Touch screen



Devices equipped with proximity and temperature sensors, for central management of all functions through dedicated pages. Available in 4" and 5" screen versions.

### Controller

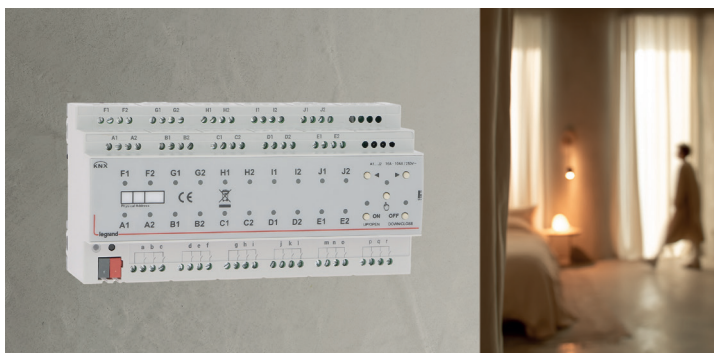

Multipurpose devices for the management of:

- Lighting with ON/OFF mode
- Motorised shutters and doors
- HVAC temperature management

### Presence sensors



In addition to the standard management of ON/OFF and dimming, these devices are able to manage advanced automations required in "green" buildings : "stand-by/maintained dimming" mode or the activation of scenarios based on the presence/absence, on natural light levels or time.

## Full interoperability with all third-party applications and systems.

In addition to providing optimum control of lighting, shutters, temperature and sockets, the KNX protocol allows functional integration with other applications: you are free to complete your project with other products (energy measurement, heating and ventilation, fire alarms, emergency lighting, etc.) or software leveraging the KNX standard, whoever supplies them!



BTicino's KNX solutions can therefore be integrated into an active general building management system, allowing to view consumption or be alerted when a fault occurs!

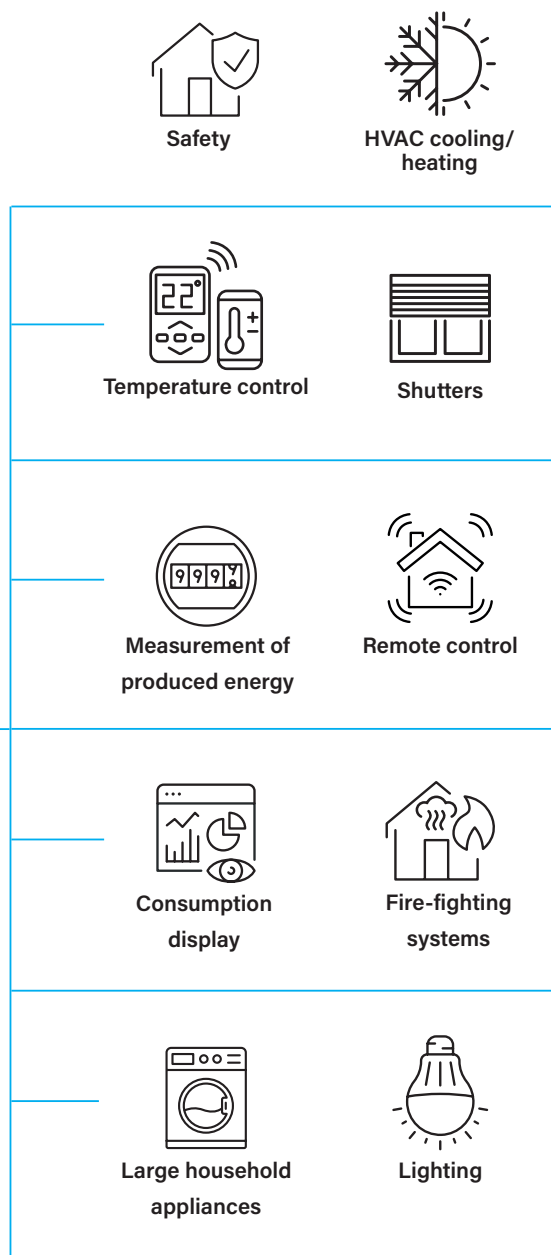

# UXOne

The all-in-one connected device replacing traditional thermostats

UXOne is a new intelligent and intuitive room management system based on an innovative and intuitive thermostat with integrated sensors for advanced control of HVAC, shading, and lighting scenarios based on room occupancy, without the need for an additional controller.

BTicino's UXOne is ideal for retrofits, as it only requires replacing the existing thermostat, without the need for significant renovation work.



## Wireless communication

In addition to the UXOne thermostat, the heart of the offer available in white and black color, the system includes a series of connected devices, such as control devices and door indicators, which can be integrated with other connected devices in the Smart electrical system.



UXOne



IR wireless switch



Connected relè



Light Switch



Roller Shutters Switch

## Main benefits

### Green approach

- Energy saving thanks to room occupancy and scenarios management
- Fit to the existing infrastructure, with wireless connectivity limiting huge investments on retrofit projects

### Productivity

- Room status monitoring through Hotel Room Supervision software
- PMS integration to improve staff efficiency

### Weel-being

- Intuitive use of thermostat functions
- A complete set of additional peripherals to control all the room equipments: lights, curtains, services and scenarios
- Contactless experience with no need of Key Card

# Standard installation

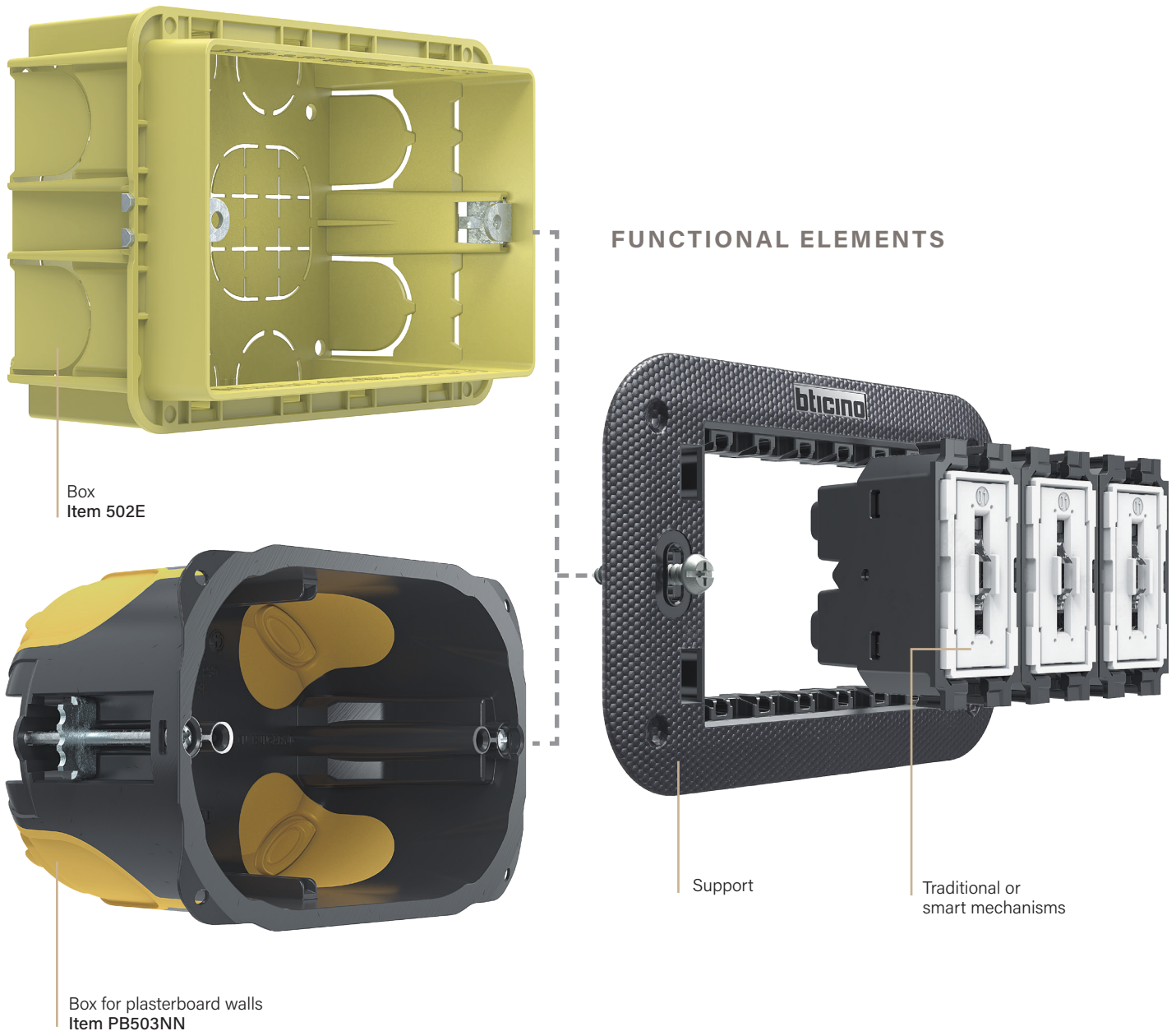

## Standard installation

Both in case of **traditional** and **connected devices**, installation is always standard, with the following characteristics:

- traditional wiring;
- flush mounted or plasterboard boxes, typically 2 to 6 modules;
- no configuration required.

## Your work does not change, but is made easier

The rules and procedures for the installation of the electric system don't change. Moreover, with the installation of the aesthetic components at the end of the works, you will hand to your customer a perfect and perfectly looking system.

## A sustainable system

The device mounting boxes are made from recycled materials, and their long service life, which reduces the need for replacements, further lowers the environmental impact throughout the entire product life cycle.

## Site activity sequence

- Install the system, fully working, but without aesthetic elements (cover plates and covers)
- Protect the light point using the protective shell (supplied with the support))
- After completing all the works (including the painting of the walls), install the cover plates and the covers

## More advantages

- When repainting the walls in the future, the customer will be able to easily remove the light point aesthetic components, cover plates and covers, and just as easily replace them on completion of the works
- After a few years the customer decides to change light points?  
It is possible to simply change the covers, without touching the mechanisms

## AESTHETIC ELEMENTS

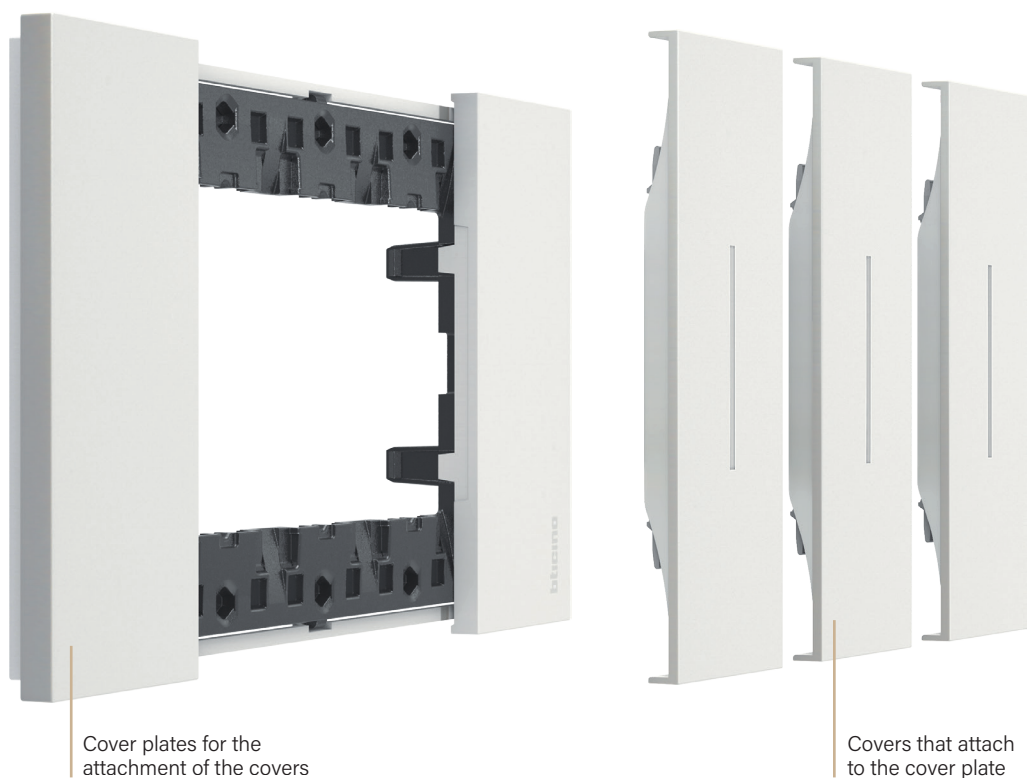

## SUITABLE FOR ALL MODULARITIES

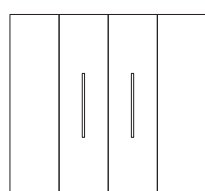

2 modules

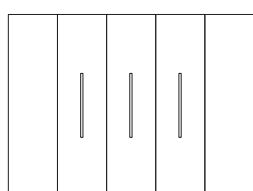

3 modules

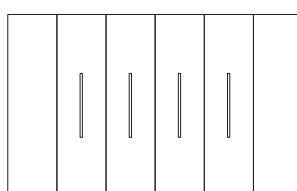

4 modules

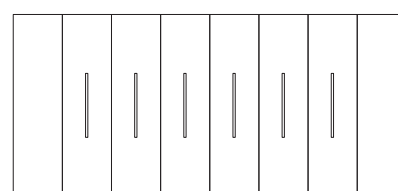

6 modules

# InWall installation

Living Now can now also be installed **totally flush with the wall**.

This solution is based on the use of accessories designed to guarantee a precise, patent-protected installation, ensuring perfect planarity between wall and the completed wiring device assembly, suitable for both masonry and plasterboard walls.

## Accessory for masonry walls

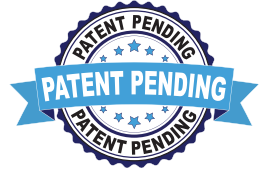

### FUNCTIONAL ELEMENTS

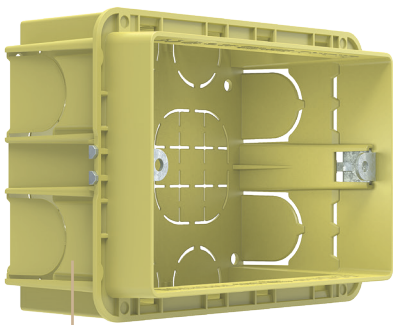

Box  
Item 503E

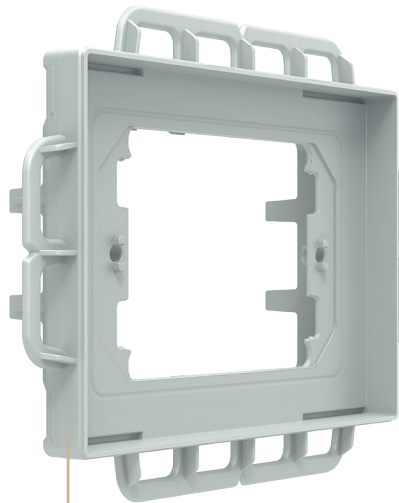

Accessory for  
masonry walls  
Item 503EF  
(complete with protective cover)



Protection cover

## Accessory for plasterboard walls

### FUNCTIONAL ELEMENTS

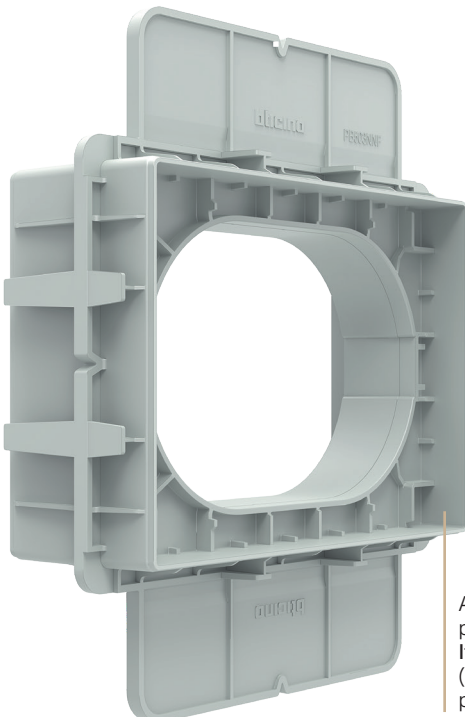

Accessory for  
plasterboard walls  
Item PB503NNF  
(complete with  
protective cover)



Box for  
plasterboard walls  
Item PB503NN



Protection cover

## Simple and sustainable installation

The components are made of high-quality recycled materials, following an extremely precise manufacturing process to ensure durability and perfect finish. Installation is intuitive and standardised, for both new constructions and major renovations. Thanks to the reduced number of accessories, the installer can easily handle all configurations without errors or complexity.

### FUNCTIONAL ELEMENTS

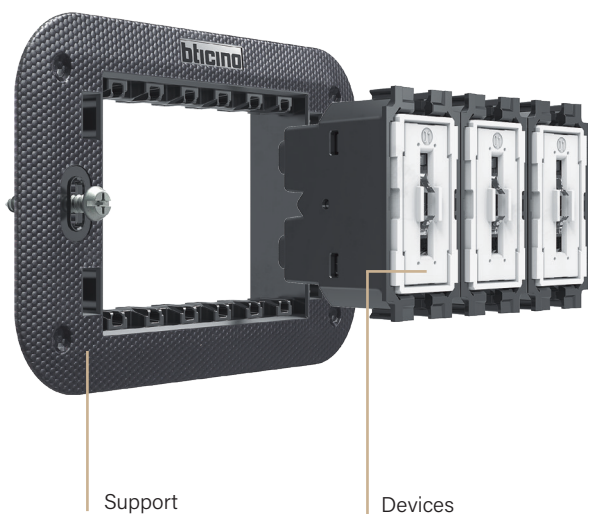

### AESTHETIC ELEMENTS

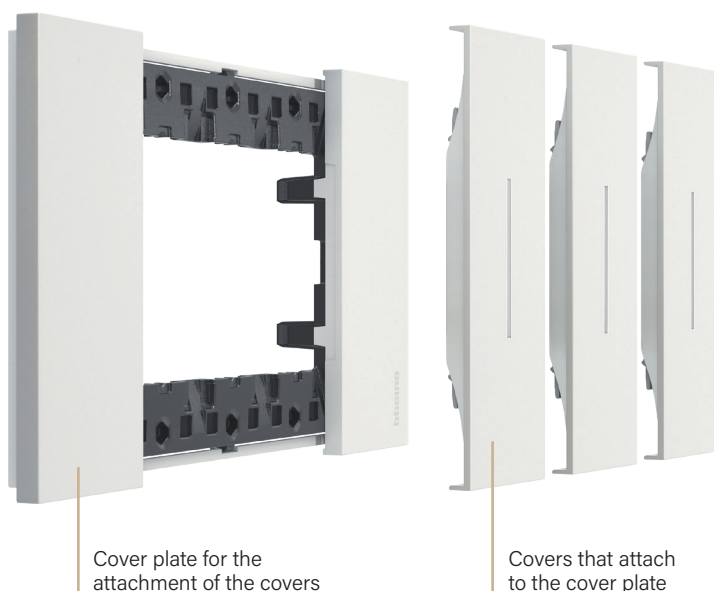

### SUITABLE FOR ALL MODULARITIES

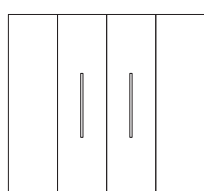

2 modules

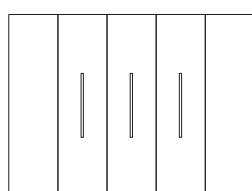

3 modules

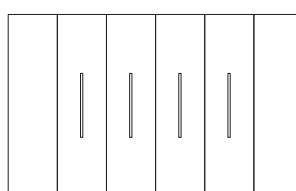

4 modules

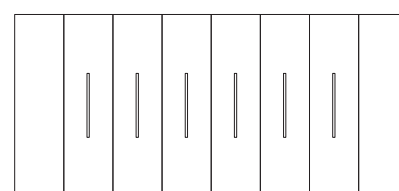

6 modules

# InWall installation

The new junction boxes can also be installed flush with the wall, with the use of a dedicated accessory kit, completely integrating the electrical system into the architecture, eliminating all protrusions and ensuring visual continuity of the walls.

## New junction boxes

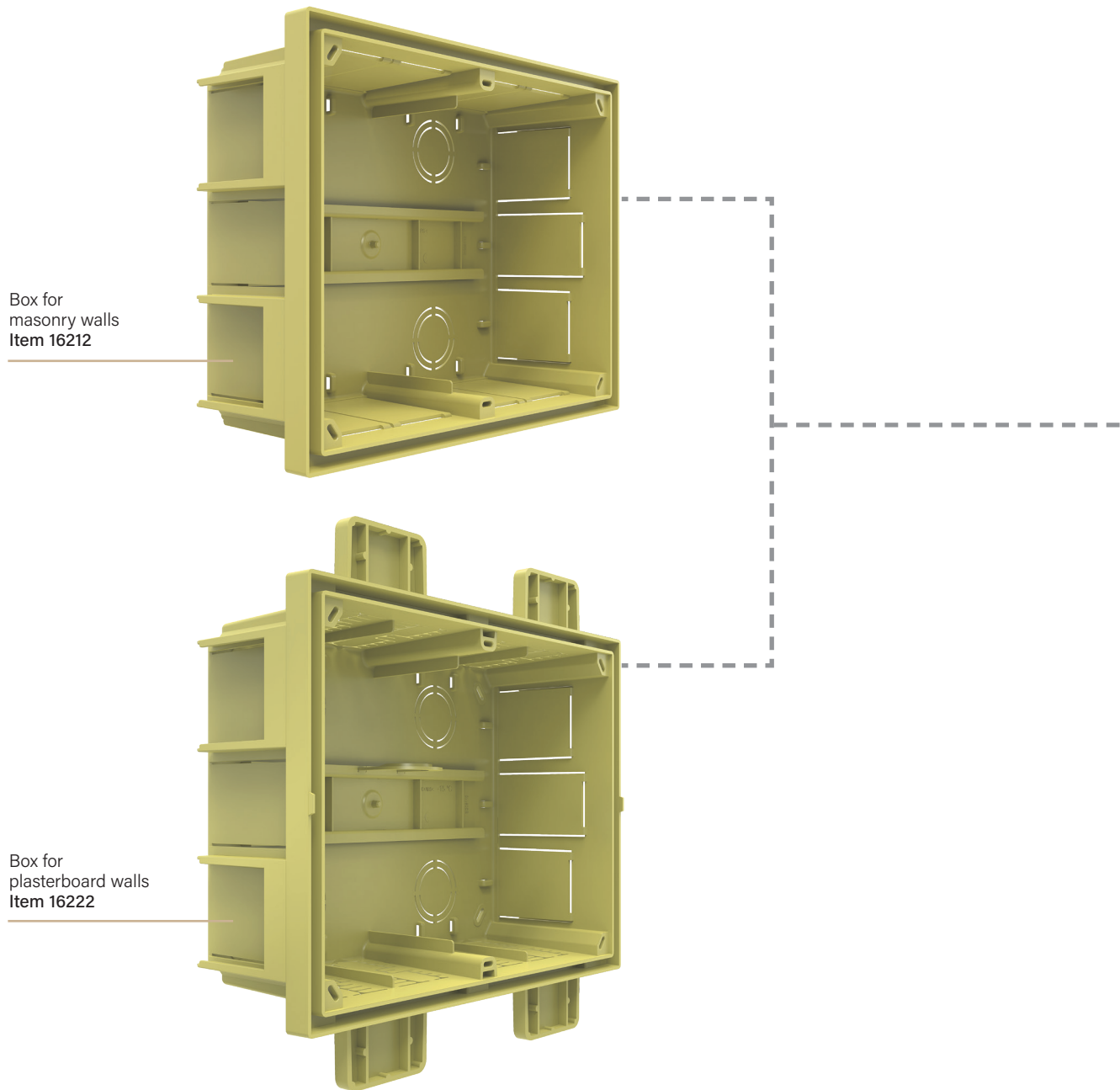

Note: For flush-to-wall installation of junction boxes for masonry walls, before embedding the box into the wall, screw on the frame of the accessory kit, keeping the most protruding edge visible.

## Single accessory kit for masonry and plasterboard



## BOXES AVAILABLE IN TWO FORMATS

### 2-compartment boxes

(internal dimensions 193 x 149 x 82 mm)

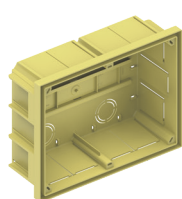

Masonry walls  
Item 16212

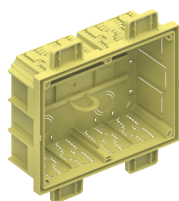

Plasterboard walls  
Item 16222

### 3-compartment boxes

(internal dimensions 284 x 149 x 82 mm)

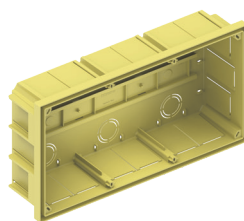

Masonry walls  
Item 16213

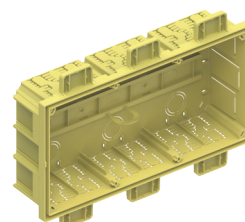

Plasterboard walls  
Item 16223

Quick guide to choosing the most suitable solution for your project

**CONTROL DEVICE FINISHES**

**1.** Choose the colour of the control devices for your system from the 6 available finishes.

**COVERS**



**New**

**METALLIC EFFECT**

Champagne - Steel - Bronze



**SATIN EFFECT**

White - Sand - Black

**COVER PLATE FINISHES**

**2.** Match the preferred cover plate finish to obtain either a monochromatic solution or a contrast using different colours and materials.

**ZAMAK MONOCHROME - *New metallic collection***

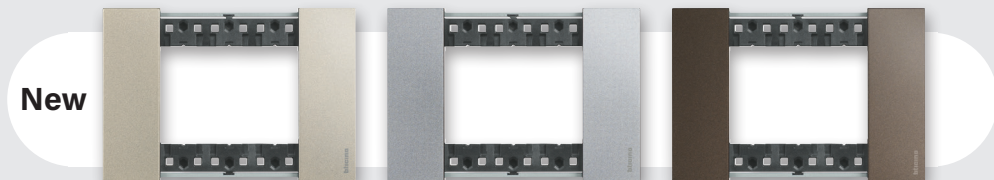

**New**

Champagne - *KC*

Steel - *KS*

Bronze - *KB*

**TECHNOPOLYMER MONOCHROME**

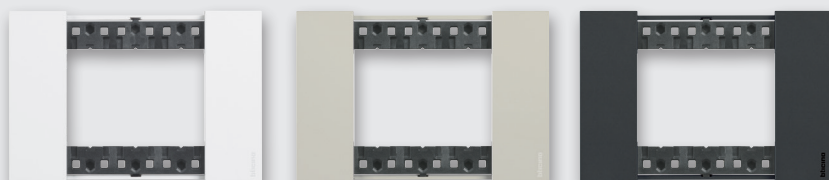

White - *KW*

Sand - *KM*

Black - *KG*

**TECHNOPOLYMER**



Ice - *DW*

Night - *DG*

**ZAMAK**

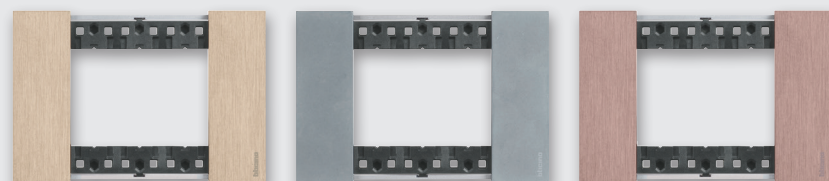

Gold - *ZW*

Moon - *NW*

Copper - *ZM*



Space - *NG*

Steel - *ZG*

**WOOD**



Oak - *LM*

Walnut - *LG*

**INSTALLATION**

**3.** Choose whether to install the system on the wall or flush-to-wall, and define the number of modules for each control point.

**FLUSH-WALL**

**New**



**TRADITIONAL**



**MODULARITY**

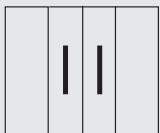

2 modules



3 modules



4 modules



6 modules

**TECHNOLOGIES**

**4.** Choose the most suitable technology according to the complexity and size of the system.



Traditional system

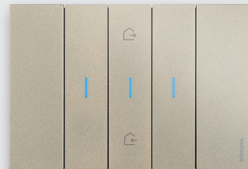

Living Now with Netatmo Smarth Home radio controls

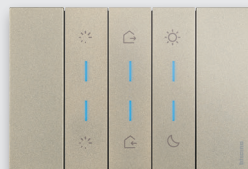

Living Now MyHome Smarth Home controls on SCS bus

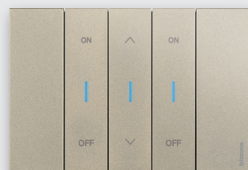

Living Now KNX Connected controls on KNX bus

**Examples of combinations**

**ZAMA MONOCHROME**  
*New metallic collection*



**TECHNOPOLYMER MONOCHROME**

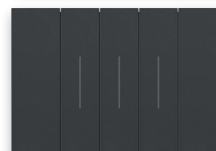

**TECHNOPOLYMER**



**ZAMAK**

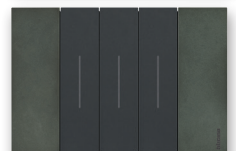
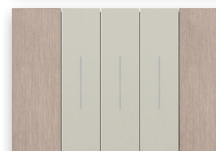
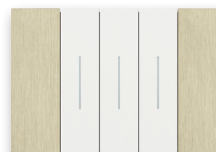

**WOOD**

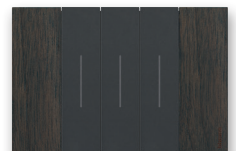

# Living Now

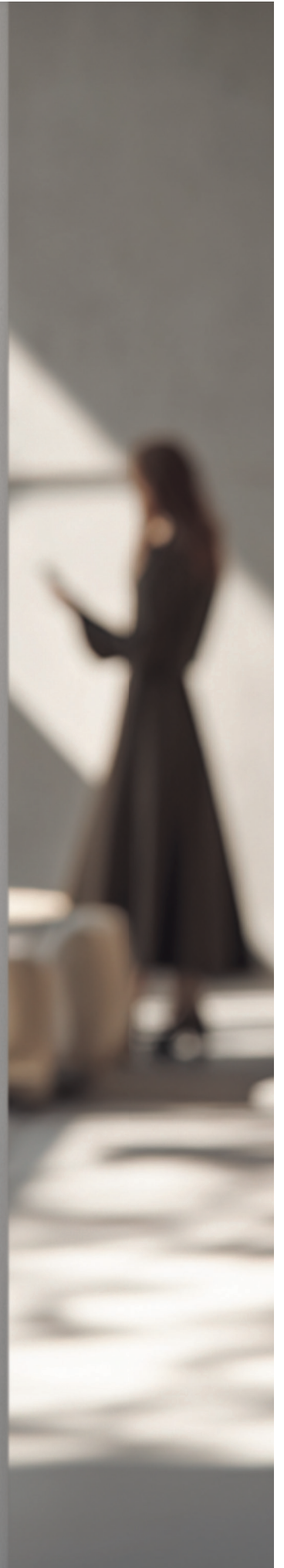

## SECTION 1

Living Now

# Switches, sockets, other functions and covers, for electrical system.

How to choose devices for the composition of the electrical system

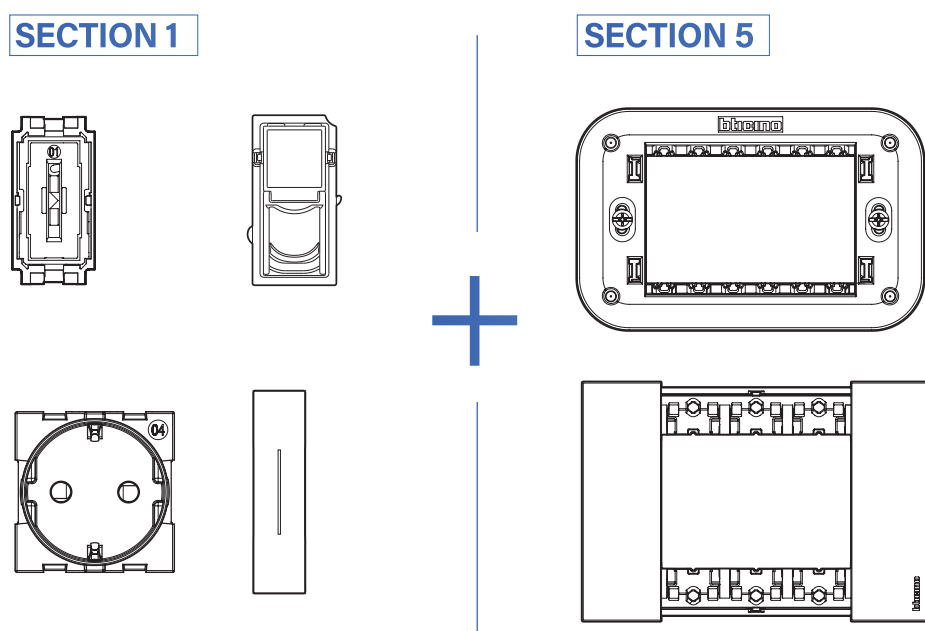

Type of system	Catalog section
<b>Living Now standard system</b> (Switches, sockets, other functions and covers for the residential electrical system)	<b>1 + 5</b>
Living Now with Netatmo (Connected controls for the smart home, which communicate via radio)	2 + 1 + 5
Living Now MyHOME (Advanced Smart Home controls, which communicate via SCS BTicino bus)	3 + 1 + 5
Living Now KNX (Connected controls for the smart home, which communicate via KNX standard bus)	4 + 1 + 5
Living Now electrical system completion (cover plates range, boxes, accessories)	5

















# Living Now standard electrical system

## main controls



Devices to be completed with appropriate covers as indicated below

**Table of cover choices for main controls**

		NEUTRAL LIGHTABLE COVER	
		1 module	2 modules
			
Item	Description	Item	Item
○ K4001	 1P 10 AX, 250 V~, 1-way switch, screw and plates terminals, lighttable - 1 module	□ KW01	□ KW01M2
○ K4001A	 1P 10 AX, 250 VA, 1-way switch, automatic terminals, lighttable - 1 module	■ KG01	■ KG01M2
○ K4001M2A	 1P 10 AX, 250 VA, 1-way switch, automatic terminals, lighttable - 2 modules	□ KM01	□ KM01M2
○ K4003	 1P 10 AX, 250 V~ 2-way switch, screw and plates terminals, lighttable - 1 module	■ KC01	■ KC01M2
○ K4003A	 1P 10 AX, 250 V~ 2-ways switch, automatic terminals, lighttable - 1 module	■ KS01	■ KS01M2
○ K4003M2A	 1P 10 AX, 250 V~, 2-ways switch, automatic terminals, lighttable - 2 modules	■ KB01	■ KB01M2
○ K4004	 1P 10 AX, 250 V~ 4-way switch, screw and plates terminals - 1 module		
○ K4004L	 1P 10 AX, 250 V~ LIT 4-ways switch, screw and plates terminals, with white LED for backlighting (the LED is not interchangeable) - 1 module		
○ K4004LB	 1P 10 AX, 250 V~ LIT 4-ways switch, screw and plates terminals, with blue LED for backlighting (the LED is not interchangeable) - 1 module		
○ K4004V127L	 1P 10 AX, 127 V~ LIT 4-way switch, screw and plates terminals, with white LED for backlighting (the LED is not interchangeable) - 1 module		
○ K4004V127LB	 1P 10 AX, 127 V~ LIT 4-way switch, screw and plates terminals, with blue LED for backlighting (the LED is not interchangeable) - 1 module		
○ K4005	 1P (NO) 10 A, 250 V~ pushbutton, screw and plates terminal, lighttable - 1 module		
○ K4005A	 1P (NO) 10 A, 250 V~ pushbutton, automatic terminals, lighttable - 1 module		
○ K4005M2A	 1P (NO) 10 A, 250 V~ pushbutton, automatic terminals, lighttable - 2 modules		

**Note:** for solutions requiring 2-module covers for the main controls, it will be necessary to install two "half-module blanking modules" (item K4949) at the sides of the control, see examples of installation in the "Installation and cover plate range" section at the bottom of the catalogue.

# Living Now standard electrical system

## main controls



### LIGHTABLE COVERS WITH SYMBOLS

high brightness		light symbol		bell symbol		key symbol	
1 module	2 modules	1 module	2 modules	1 module	2 modules	1 module	2 modules
Item	Item	Item	Item	Item	Item	Item	Item
□KW01X	□KW01M2X	□KW01A	□KW01M2A	□KW01D	□KW01M2D	□KW01F	□KW01M2F
■KG01X	■KG01M2X	■KG01A	■KG01M2A	■KG01D	■KG01M2D	■KG01F	■KG01M2F
□KM01X	□KM01M2X	□KM01A	□KM01M2A	□KM01D	□KM01M2D	□KM01F	□KM01M2F

Symbols can also be applied to cover plates in Champagne, Steel and Bronze finishes, thanks to **MySwitch Configurator**, the online configurator.

In MySwitch Configurator, a wide gallery of symbols and icons is available to choose from.

In addition, exclusively for cover plates in Champagne, Steel and Bronze finishes, it is possible to create customised symbols and text.



Scan the QR code to access MySwitch Configurator

### LED for backlighting of the basic control devices

LED color	230 V ~	127 V ~	12/24 V ~	Recommended use
White	K4743V230T			high luminosity for daytime load
White		K4743V127T		high luminosity for daytime load
Red	K4743V230R			high luminosity for daytime load
White	LN4743/230T			night signal
White			LN4743/12T	night signal
Blue	Y4743V230B			night signal
Blue			Y4743V12B	night signal
Red/Green	K4743V230RG			spare part for item K4027H
Red/Green		K4743V127RG		spare part for item K4027V127H

#### Note:

- for further information on LEDs, please refer to the "LEDs for backlighting" section, available later in the Catalogue.
- all connected products are equipped with a BLUE LED that cannot be replaced with other LEDs.

Therefore, in order to achieve colour uniformity in a smart system, it is recommended to use BLUE LEDs also on traditional devices.

## Living Now standard electrical system

Lightable cover with symbols, for items:  
K4001, K4003, K4004, K4004L, K4004LB, K4005, K4034



KM01PN KM01RN KM01SN KM01M2PN KM01M2RN

## control for shutters, fan and touchless control



K4027 K4036 K4037N KM4017

### Cover for the comand of heating, ventilation, boiler

Item	
<input type="checkbox"/> KW01PN	<b>1 module</b> Cover for heating comand
<input checked="" type="checkbox"/> KG01PN	
<input type="checkbox"/> KM01PN	
<input type="checkbox"/> KW01RN	Cover for ventilation comand
<input checked="" type="checkbox"/> KG01RN	
<input type="checkbox"/> KM01RN	
<input type="checkbox"/> KW01SN	Cover for boiler comand
<input checked="" type="checkbox"/> KG01SN	
<input type="checkbox"/> KM01SN	
<input type="checkbox"/> KW01M2PN	<b>2 modules</b> Cover for heating comand
<input checked="" type="checkbox"/> KG01M2PN	
<input type="checkbox"/> KM01M2PN	
<input type="checkbox"/> KW01M2RN	Cover for ventilation comand
<input checked="" type="checkbox"/> KG01M2RN	
<input type="checkbox"/> KM01M2RN	
<input type="checkbox"/> KW01M2SN	Cover for boiler comand
<input checked="" type="checkbox"/> KG01M2SN	
<input type="checkbox"/> KM01M2SN	

Devices to be completed with appropriate covers as indicated below

### Changeover switch and pushbuttons

Item	
<input type="radio"/> K4027	1P 10 AX, 250 VA changeover switch, double-key 1-0-2, not lightable - 1 module
<input type="radio"/> K4037N	10 A 250 VA double pushbutton 1 P (NO) + 1 P (NO) interlocked for shutters, not lightable - 1 module
<input type="radio"/> K4036	10 A 250 VA double pushbutton 1 P (NO) + 1 P (NO) not interlocked, not lightable - 1 module





### Fan controller



<input type="checkbox"/> KW4017	Fan controller 240VA 100W 50Hz - The cover of the selected colour is supplied in the same box as the fan controller - for Indian std. installations - 2 module
<input checked="" type="checkbox"/> KG4017	
<input type="checkbox"/> KM4017	
<input checked="" type="checkbox"/> KC4017	
<input checked="" type="checkbox"/> KS4017	
<input checked="" type="checkbox"/> KB4017	
<input type="checkbox"/> KW4018	Fan controller 110-220 VA 15-160 VA 50-60Hz - The cover of the selected colour is supplied in the same box as the fan controller - 1 module
<input checked="" type="checkbox"/> KG4018	
<input type="checkbox"/> KM4018	
<input checked="" type="checkbox"/> KC4018	
<input checked="" type="checkbox"/> KS4018	
<input checked="" type="checkbox"/> KB4018	





# Living Now standard electrical system

## cover for shutters, fan and touchless control



Item	Cover
<input type="checkbox"/> KW06 <input checked="" type="checkbox"/> KG06 <input type="checkbox"/> KM06  <input checked="" type="checkbox"/> KC06 <input checked="" type="checkbox"/> KS06 <input checked="" type="checkbox"/> KB06	<b>1 module</b>  Cover for item K4027
<input type="checkbox"/> KW06V <input checked="" type="checkbox"/> KG06V <input type="checkbox"/> KM06V  <input checked="" type="checkbox"/> KC06V <input checked="" type="checkbox"/> KS06V <input checked="" type="checkbox"/> KB06V	 Cover for item K4027 vertical installation
<input type="checkbox"/> KW05L <input checked="" type="checkbox"/> KG05L <input type="checkbox"/> KM05L  <input checked="" type="checkbox"/> KC05L <input checked="" type="checkbox"/> KS05L <input checked="" type="checkbox"/> KB05L	 Cover for item K4036
<input type="checkbox"/> KW05 <input checked="" type="checkbox"/> KG05 <input type="checkbox"/> KM05  <input checked="" type="checkbox"/> KC05 <input checked="" type="checkbox"/> KS05 <input checked="" type="checkbox"/> KB05	 Cover for item K4037N
<input type="checkbox"/> KW05V <input checked="" type="checkbox"/> KG05V <input type="checkbox"/> KM05V  <input checked="" type="checkbox"/> KC05V <input checked="" type="checkbox"/> KS05V <input checked="" type="checkbox"/> KB05V	 Cover for item K4037N vertical installation

<input type="checkbox"/> KW06M2 <input checked="" type="checkbox"/> KG06M2 <input type="checkbox"/> KM06M2  <input checked="" type="checkbox"/> KC06M2 <input checked="" type="checkbox"/> KS06M2 <input checked="" type="checkbox"/> KB06M2	<b>2 modules</b>  Cover for item K4027
<input type="checkbox"/> KW05M2 <input checked="" type="checkbox"/> KG05M2 <input type="checkbox"/> KM05M2  <input checked="" type="checkbox"/> KC05M2 <input checked="" type="checkbox"/> KS05M2 <input checked="" type="checkbox"/> KB05M2	 Cover for item K4037N



Item	Cover
<input type="checkbox"/> KW06M2V <input checked="" type="checkbox"/> KG06M2V <input type="checkbox"/> KM06M2V  <input checked="" type="checkbox"/> KC06M2V <input checked="" type="checkbox"/> KS06M2V <input checked="" type="checkbox"/> KB06M2V	<b>2 modules</b>  Cover for item K4027 vertical installation
<input type="checkbox"/> KW05M2V <input checked="" type="checkbox"/> KG05M2V <input type="checkbox"/> KM05M2V  <input checked="" type="checkbox"/> KC05M2V <input checked="" type="checkbox"/> KS05M2V <input checked="" type="checkbox"/> KB05M2V	 Cover for item K4037N vertical installation
<input type="checkbox"/> KW06M2VMC <input checked="" type="checkbox"/> KG06M2VMC <input type="checkbox"/> KM06M2VMC  <input checked="" type="checkbox"/> KC06M2VMC <input checked="" type="checkbox"/> KS06M2VMC <input checked="" type="checkbox"/> KB06M2VMC	 Cover for item K4027
<input type="checkbox"/> KW05M2VMC <input checked="" type="checkbox"/> KG05M2VMC <input type="checkbox"/> KM05M2VMC  <input checked="" type="checkbox"/> KC05M2VMC <input checked="" type="checkbox"/> KS05M2VMC <input checked="" type="checkbox"/> KB05M2VMC	 Cover for item K4037N





# Living Now standard electrical system

## dimmer











Devices to be completed with appropriate covers as indicated below

Item	Dimmer
<input type="radio"/> K4410	 Pushbutton dimmer for ballast lamp with 0-10V output. 100 to 240 VA 50 to 60 Hz - 2 modules
<input type="radio"/> K4418	 Universal Pushbutton Dimmer - with neutral, 3 wires. Can be associated with one or several push-buttons (non illuminated type). Each push-button able to perform the On/ Off and dimming function. Memory level function: Lights come on again at the same lighting level as before they were last switchoff. Lower and upper thresholds setting. Indicator/locator function. For all types of lamps : - Dimmable LEDs and CFLs : 0 to 150 W (15 lamps max.) - Halogen, incandescent 230 V~ : 0 to 150 W - Halogen with ferromagnetic or electronic transformer : 0 to 150 VA. Depth 35 mm (with neutral). Standby consumption < 5 mW - 1 module
<input type="radio"/> K4418M2	As above - 2 modules
<input type="radio"/> K4419M2	 As above - 2 wires - 2 modules

Item	Cover
<input type="checkbox"/> KW19 <input type="checkbox"/> KG19 <input type="checkbox"/> KM19  <input type="checkbox"/> KC19 <input type="checkbox"/> KS19 <input type="checkbox"/> KB19	<b>1 module</b>  Cover for item K4410
<input type="checkbox"/> KW01N <input type="checkbox"/> KG01N <input type="checkbox"/> KM01N  <input type="checkbox"/> KC01N <input type="checkbox"/> KS01N <input type="checkbox"/> KB01N	 Cover for item K4418
<input type="checkbox"/> KW01M2N <input type="checkbox"/> KG01M2N <input type="checkbox"/> KM01M2N  <input type="checkbox"/> KC01M2N <input type="checkbox"/> KS01M2N <input type="checkbox"/> KB01M2N	<b>2 modules</b>  Lightable cover for item K4418M2
<input type="checkbox"/> KW01M2P <input type="checkbox"/> KG01M2P <input type="checkbox"/> KM01M2P  <input type="checkbox"/> KC01M2P <input type="checkbox"/> KS01M2P <input type="checkbox"/> KB01M2P	 Lightable cover for item K4419M2

**Table for selecting dimmers based on the load to be controlled**

Type	Actuation type	Item	Current range	 Incandescent and halogen	 Halogen with electronic transformer	 Compact fluorescent	 Led lamp	 Fluorescent with 0-10 V ballast
 Ballast 2 mod.	Push	K4410	240 V 100 V					40 - 600 VA
 Universal push neutral 1 mod.	Push	K4418	240 V 100 V	150 W 75 W	150 W 75 W	150 W 75 W	150 W 75 W	
 Universal push neutral 2 mod.	Push	K4418M2	240 V 100 V	150 W 75 W	150 W 75 W	150 W 75 W	150 W 75 W	
 Universal push without neutral 2 mod.	Push	K4419M2	240 V 100 V	150 W 75 W	150 W 75 W	150 W 75 W	150 W 75 W	





White (KW)  Black (KG)  Sand (KM)  Champagne (KC)  Steel (KS)  Bronze (KB)  Neutral item (K) (without cover)

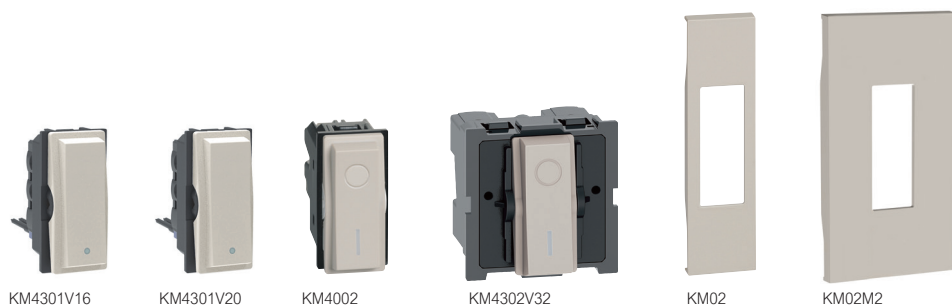

# Living Now standard electrical system

## other switches



Devices to be completed with appropriate covers as indicated below

Item	Indian standard switches
<input type="checkbox"/> KW4301V16 <input checked="" type="checkbox"/> KG4301V16 <input type="checkbox"/> KM4301V16  <input checked="" type="checkbox"/> KC4301V16 <input checked="" type="checkbox"/> KS4301V16 <input checked="" type="checkbox"/> KB4301V16	 <p>1P 16 AX, 250 VA, 1-way switch, screw and plates terminals, with white LED for backlighting (the LED is not interchangeable) - 1 module</p>
<input type="checkbox"/> KW4301V20 <input checked="" type="checkbox"/> KG4301V20 <input type="checkbox"/> KM4301V20  <input checked="" type="checkbox"/> KC4301V20 <input checked="" type="checkbox"/> KS4301V20 <input checked="" type="checkbox"/> KB4301V20	 <p>1P 20 AX, 250 VA, 1-way switch, screw and plates terminals, with white LED for backlighting (the LED is not interchangeable) - 1 module</p>
<input type="checkbox"/> KW4002 <input checked="" type="checkbox"/> KG4002 <input type="checkbox"/> KM4002  <input checked="" type="checkbox"/> KC4002 <input checked="" type="checkbox"/> KS4002 <input checked="" type="checkbox"/> KB4002	 <p><b>Two-pole switches</b>            2P 16 AX, 250 VA, lightable switch - 1 module</p>
<input type="checkbox"/> KW4302V32 <input checked="" type="checkbox"/> KG4302V32 <input type="checkbox"/> KM4302V32  <input checked="" type="checkbox"/> KC4302V32 <input checked="" type="checkbox"/> KS4302V32 <input checked="" type="checkbox"/> KB4302V32	 <p><b>Indian standard two-pole switches</b>            2P 32 A, 250 VA switch, with white LED for backlighting (the LED is not interchangeable) - 1 module</p>





Item	Cover
<input type="checkbox"/> KW02 <input checked="" type="checkbox"/> KG02 <input type="checkbox"/> KM02  <input checked="" type="checkbox"/> KC02 <input checked="" type="checkbox"/> KS02 <input checked="" type="checkbox"/> KB02	<p><b>1 module</b></p>  <p>Cover for Item KW4301V16, KW4301V20 and KW4002            Cover for Item KG4301V16, KG4301V20 and KG4002            Cover for Item KM4301V16, KM4301V20 and KM4002            Cover for Item KC4301V16, KC4301V20 and KC4002            Cover for Item KS4301V16, KS4301V20 and KS4002            Cover for Item KB4301V16, KB4301V20 and KB4002</p>
<input type="checkbox"/> KW02M2 <input checked="" type="checkbox"/> KG02M2 <input type="checkbox"/> KM02M2  <input checked="" type="checkbox"/> KC02M2 <input checked="" type="checkbox"/> KS02M2 <input checked="" type="checkbox"/> KB02M2	<p><b>2 modules</b></p>  <p>Cover for Item KW4302V32, KW4301V16, KW4301V20 and KW4002            Cover for Item KG4302V32, KG4301V16, KG4301V20 and KG4002            Cover for Item KM4302V32, KM4301V16, KM4301V20 and KM4002            Cover for Item KC4302V32, KC4301V16, KC4301V20 and KC4002            Cover for Item KS4302V32, KS4301V16, KS4301V20 and KS4002            Cover for Item KB4302V32, KB4301V16, KB4301V20 and KB4002</p>

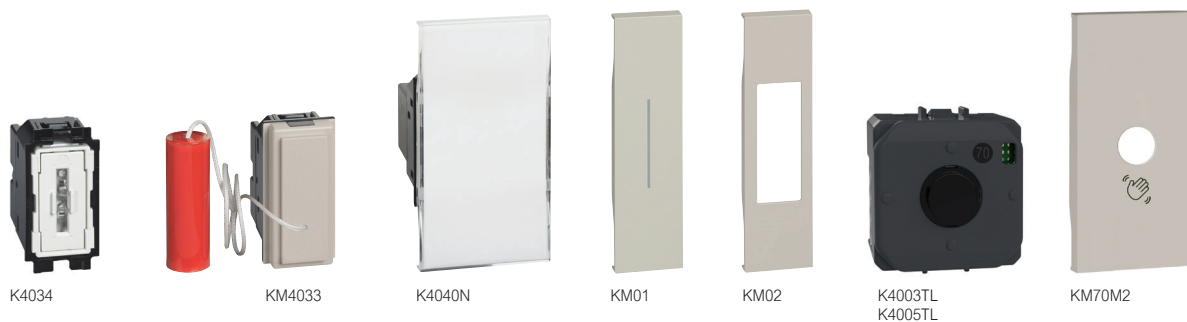

# Living Now standard electrical system

## other pushbuttons and touchless controls



Devices to be completed with appropriate covers as indicated below

Item	Pushbutton
<input type="radio"/> K4034	 Pushbutton with 1 changeover contact 10 A 250 VA - 1P (NO) / 1P (NC), lightable - 1 module
<input type="checkbox"/> KW4033 <input checked="" type="checkbox"/> KG4033 <input type="checkbox"/> KM4033 <input checked="" type="checkbox"/> KC4033 <input checked="" type="checkbox"/> KS4033 <input checked="" type="checkbox"/> KB4033	<b>Pull cord pushbutton</b>  10 A 250 VA pull-cord pushbutton 1 P (NO) and 1 P (NC) - 1 module
<input type="radio"/> K4040N	<b>Plate pushbutton</b>  3 A 250 VA door pushbutton - backlit with LED technology (already installed), cover supplied in package with the pushbutton - 2 modules
<input type="checkbox"/> KW01 <input checked="" type="checkbox"/> KG01 <input type="checkbox"/> KM01 <input checked="" type="checkbox"/> KC01 <input checked="" type="checkbox"/> KS01 <input checked="" type="checkbox"/> KB01	<b>Cover</b> <b>1 module</b>  Cover lightable for item K4034
<input type="checkbox"/> KW02 <input checked="" type="checkbox"/> KG02 <input type="checkbox"/> KM02 <input checked="" type="checkbox"/> KC02 <input checked="" type="checkbox"/> KS02 <input checked="" type="checkbox"/> KB02	<b>Cover for pull cord pushbutton</b> <b>1 module</b>  Cover for item KW4033 Cover for item KG4033 Cover for item KM4033 Cover for item KC4033 Cover for item KS4033 Cover for item KB4033

Item	Touchless switch
<input type="radio"/> K4005TL	 Touchless switch for doors, electric and electromagnet door locks. Allows to control door opening by simply passing the hand in front of the switch. Detection distance adjustable from 10 cm (default setting) to 30 cm LED indicator light, activated by default (can be switched off). Mechanism depth 25 mm, compatible with all types of flush-mounting boxes. Power supply 12 - 24 - 48 V= Available modes: - ON/OFF mode/pulse mode (by default mode) - NC/NO mode (by default mode) - 2 modules.
<input type="radio"/> K4003TL	 Touchless switch for lighting. Allows to control light sources by simply passing the hand in front of the switch. Detection distance 6 cm LED indicator light, activated by default (can be switched off). Mechanism depth 20 mm, compatible with all types of flush-mounting boxes. 2 possibilities of cabling: With neutral, 3 wires. Accepted power by lamp type: - LEDs and CFL lamps: 200 W LED - Incandescent and halogen lamps: 200 W - LEDs, CFLs, halogen lamps, fluorescent tubes with ferromagnetic or electronic transformer: 200 VA Without neutral, 2 wires. Accepted power by lamp type: - LEDs and CFL lamps: 5 to 200 W LED - Incandescent and halogen lamps: 5 to 200 W - LEDs, CFLs, halogen lamps, fluorescent tubes with ferromagnetic or electronic transformer: 5 to 200 VA 4 modes available: - 1-way switch mode: wiring with or without neutral - 2-way switch mode: wiring with neutral mandatory - Master/Slave mode: wiring with neutral mandatory, 3 slaves max. - Push-button mode: wiring with neutral mandatory, for controlling relays or a "with Netatmo" micromodule - 2 modules
<input type="checkbox"/> KW70M2 <input checked="" type="checkbox"/> KG70M2 <input type="checkbox"/> KM70M2 <input checked="" type="checkbox"/> KC70M2 <input checked="" type="checkbox"/> KS70M2 <input checked="" type="checkbox"/> KB70M2	<b>Cover</b> <b>2 modules</b>  Covers for touchless controls K4003TL e K4005TL - 2 modules

**Touchless controls**  
 With these new highly responsive controls, you only need to bring your hand close without touching the surface to turn on - off the light, ensuring high hygiene even for switches.



# Living Now standard electrical system

other control devices

## Options for the installation of touchless switches for lighting Item K4003TL

### Wiring without neutral

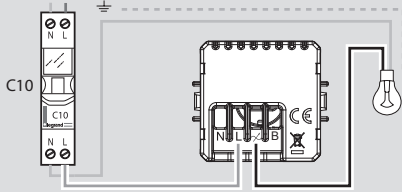

### Wiring Line + Neutral

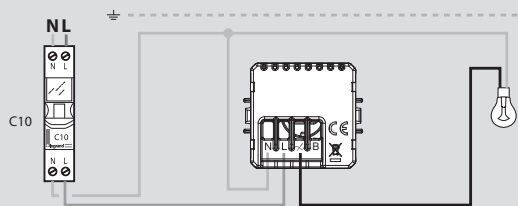

### Wiring in NO mode

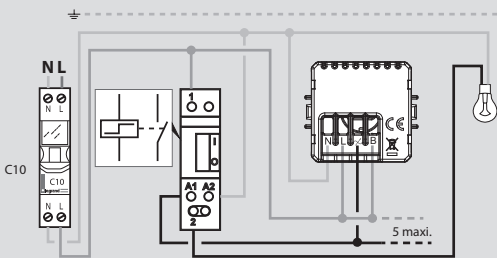

### Wiring in master/slave mode

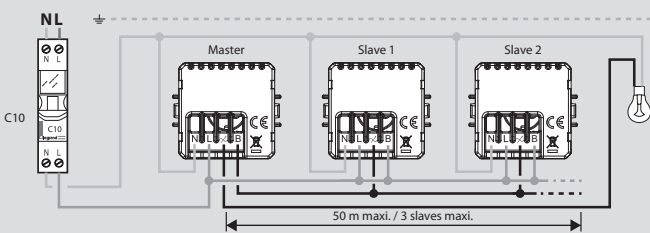

### Wiring with micromodule

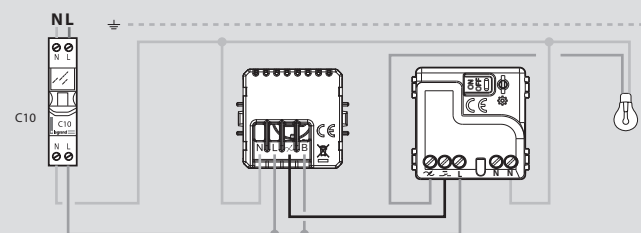

## Installation of touchless switches for doors Item K4005TL

### Wiring diagram

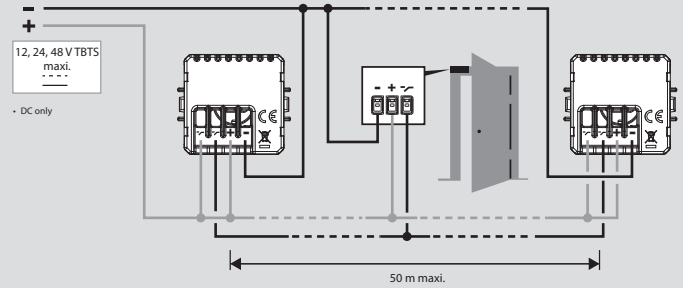





# Living Now standard electrical system



## IR switches and thermostats



Devices to be completed with appropriate covers as indicated below

Item	Interruttori IR
<input type="radio"/> K4431	 <p>Switch with passive infrared ray movement sensor, suitable for all types of load including LED lamps - 3 wires - variable-threshold twilight circuit with possibility of exclusion - timing circuit to delay switching off adjustable from 30 seconds to 10 minutes - 230 VA power supply - 1 module</p>
<input type="radio"/> K4432N	 <p><b>Note:</b> for further information, see the technical section at the end of the Catalogue</p> <p>Switch with passive infrared motion sensor suitable for all load types, optimized compatibility for LED lamps (up to 100W) - 2-wire - twilight circuit with adjustable threshold and exclusion option - timer circuit for adjustable switch-off delay from 5 seconds to 30 minutes - 170° detection angle - 240 V AC power supply - 2 modules.</p>
<input type="radio"/> K4432SN	 <p>Switch with passive infrared motion sensor suitable for all load types, optimized compatibility for LED lamps (up to 100W) - 2-wire - twilight circuit with adjustable threshold and exclusion option - timer circuit for adjustable switch-off delay from 5 seconds to 30 minutes - 170° detection angle - equipped with push selector for ON - AUTO - OFF operation modes. 240 V AC power supply - 2 modules.</p>
<input type="radio"/> K4430N	 <p>Switch with passive infrared motion sensor suitable for all load types, optimized compatibility for LED lamps (up to 500W) - 3 wires - twilight circuit with adjustable threshold and exclusion option - timer circuit for adjustable switch-off delay from 5 seconds to 30 minutes - 170° detection angle - 240 V AC power supply - 2 modules.</p>

Item	Electronic thermostats
<input type="checkbox"/> KW4441	 <p>Electronic room thermostat - relay output with 1 contact in switching free of 5(2)A potential. - power supply 230 VA - 2 modules</p>
<input checked="" type="checkbox"/> KG4441	
<input type="checkbox"/> KM4441	
<input checked="" type="checkbox"/> KC4441	
<input checked="" type="checkbox"/> KB4441	

Item	Cover
<input type="checkbox"/> KW16 <input checked="" type="checkbox"/> KG16 <input type="checkbox"/> KM16  <input checked="" type="checkbox"/> KC16 <input checked="" type="checkbox"/> KS16 <input checked="" type="checkbox"/> KB16	<b>1 module</b>  <p>Cover for item K4431</p>
<input type="checkbox"/> KW17N <input checked="" type="checkbox"/> KG17N <input type="checkbox"/> KM17N  <input checked="" type="checkbox"/> KC17N <input checked="" type="checkbox"/> KS17N <input checked="" type="checkbox"/> KB17N	<b>2 modules</b>  <p>Cover for items K4432N, K4430N</p>
<input type="checkbox"/> KW17SLN* <input checked="" type="checkbox"/> KG17SLN* <input type="checkbox"/> KM17SLN*  <input checked="" type="checkbox"/> KC17SLN* <input checked="" type="checkbox"/> KS17SLN* <input checked="" type="checkbox"/> KB17SLN*	 <p>Cover for item K4432SN</p> <p>* Cover with function selector</p>







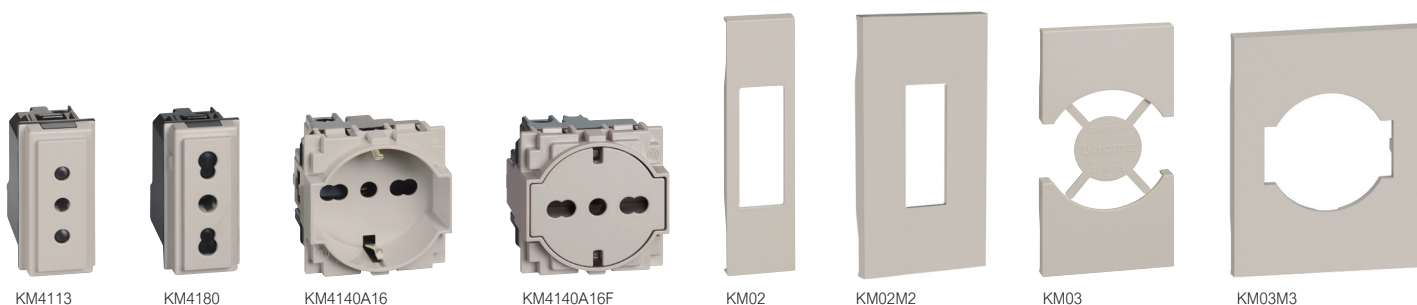

- **Note:** use item K4430N with ..17N or ..17SLN covers
- cover .. 17SLN: cover providing direct access to the selector. The device operating mode can be changed at any time as the selector is always exposed.
- cover .. 17N: cover not providing access to the selector. To change the operating mode using the selector on the product, it will be necessary to remove the cover

# Living Now standard electrical system

## italian standard sockets



Devices to be completed with appropriate covers as indicated below

Item	Italian standard sockets	Item	Cover
<ul style="list-style-type: none"> <li><input type="checkbox"/> KW4113</li> <li><input type="checkbox"/> KG4113</li> <li><input type="checkbox"/> KM4113</li> <li><input type="checkbox"/> KR4113</li> <li><input type="checkbox"/> KC4113</li> <li><input type="checkbox"/> KS4113</li> <li><input type="checkbox"/> KB4113</li> </ul>	<p>2 P+E 10 A , 250 VA socket - centre distance 19 mm - shielded tulip contacts ø 4 mm - 1 module</p>  <p>White Black Sand Red</p> <p>Champagne Steel Bronze</p>	<ul style="list-style-type: none"> <li><input type="checkbox"/> KW02</li> <li><input type="checkbox"/> KG02</li> <li><input type="checkbox"/> KM02</li> <li><input type="checkbox"/> KR02</li> <li><input type="checkbox"/> KC02</li> <li><input type="checkbox"/> KS02</li> <li><input type="checkbox"/> KB02</li> </ul>	<p><b>1 module</b></p>  <p>Cover for item KW4113, KW4180 Cover for item KG4113, KG4180 Cover for item KM4113, KM4180 Cover for item KR4113, KR4180</p> <p>Cover for item KC4113, KC4180 Cover for item KS4113, KS4180 Cover for item KB4113, KB4180</p>
<ul style="list-style-type: none"> <li><input type="checkbox"/> KW4180</li> <li><input type="checkbox"/> KG4180</li> <li><input type="checkbox"/> KM4180</li> <li><input type="checkbox"/> KR4180</li> <li><input type="checkbox"/> KC4180</li> <li><input type="checkbox"/> KS4180</li> <li><input type="checkbox"/> KB4180</li> </ul>	<p>Socket 2 P+E 16 A 250 Va.c. - centre distance 19 mm and 26 mm - shielded tulip contacts - for 2 P and 2 P+E 10 and 16 A plugs - 1 module</p>  <p>White Black Sand Red</p> <p>Champagne Steel Bronze</p>	<ul style="list-style-type: none"> <li><input type="checkbox"/> KW02M2</li> <li><input type="checkbox"/> KG02M2</li> <li><input type="checkbox"/> KM02M2</li> <li><input type="checkbox"/> KC02M2</li> <li><input type="checkbox"/> KS02M2</li> <li><input type="checkbox"/> KB02M2</li> </ul>	<p><b>2 modules</b></p>  <p>Cover for Item KW4113, KW4180 Cover for Item KG4113, KG4180 Cover for Item KM4113, KM4180</p> <p>Cover for Item KC4113, KC4180 Cover for Item KS4113, KS4180 Cover for Item KB4113, KB4180</p>
<ul style="list-style-type: none"> <li><input type="checkbox"/> KW4140A16</li> <li><input type="checkbox"/> KG4140A16</li> <li><input type="checkbox"/> KM4140A16</li> <li><input type="checkbox"/> KR4140A16</li> <li><input type="checkbox"/> KC4140A16</li> <li><input type="checkbox"/> KS4140A16</li> <li><input type="checkbox"/> KB4140A16</li> </ul>	<p><b>P40 Italian standard socket</b></p>  <p>Socket 2 P+E 16 A 250 VA - 19 and 26 mm centre distance in 2-centre configuration - protected tulip contacts; side earth contact for German standard plugs; suitable for: Italian standard plugs 2P and 2 P+E 10/16 A, and 16A, German standard plugs 2P+E 16 A - 2 modules.</p>	<ul style="list-style-type: none"> <li><input type="checkbox"/> KW03</li> <li><input type="checkbox"/> KG03</li> <li><input type="checkbox"/> KM03</li> <li><input type="checkbox"/> KR03</li> <li><input type="checkbox"/> KC03</li> <li><input type="checkbox"/> KS03</li> <li><input type="checkbox"/> KB03</li> </ul>	<p><b>Cover for P40 Italian standard socket</b></p> <p><b>2 modules</b></p>  <p>Cover suitable for italian/german standard sockets.</p>
<ul style="list-style-type: none"> <li><input type="checkbox"/> KW4140A16F</li> <li><input type="checkbox"/> KG4140A16F</li> <li><input type="checkbox"/> KM4140A16F</li> <li><input type="checkbox"/> KR4140A16F</li> <li><input type="checkbox"/> KC4140A16F</li> <li><input type="checkbox"/> KS4140A16F</li> <li><input type="checkbox"/> KB4140A16F</li> </ul>	<p><b>German and Italian standard flat socket.</b> When the plug is inserted the socket surface slides inside the casing; it returns to its initial position when the plug is taken out. Socket 2 P+E 16 A 250 VA - 19 mm and 26 mm centre distance in 2-centre configuration - protected tulip contacts; side earth contact for German standard plugs; suitable for: Italian standard plugs 2P and 2 P+E 10/16 A, and 16A, German standard plugs 2P+E 16 A. - cannot be backlit - 2 modules</p> 	<ul style="list-style-type: none"> <li><input type="checkbox"/> KW03M3</li> <li><input type="checkbox"/> KG03M3</li> <li><input type="checkbox"/> KM03M3</li> <li><input type="checkbox"/> KC03M3</li> <li><input type="checkbox"/> KS03M3</li> <li><input type="checkbox"/> KB03M3</li> </ul>	<p><b>3 modules</b></p>  <p>Cover suitable for italian/german standard sockets</p>

# Living Now standard electrical system

italian/german and german standard sockets









KM4141      KM4141G      KM4141TR



KM04      KM04P      KM04M3

Devices to be completed with appropriate covers as indicated below

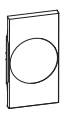
Item	German standard sockets
<input type="checkbox"/> KW4141 <input checked="" type="checkbox"/> KG4141 <input type="checkbox"/> KM4141 <input checked="" type="checkbox"/> KR4141 <input checked="" type="checkbox"/> KV4141 <input checked="" type="checkbox"/> KC4141 <input checked="" type="checkbox"/> KS4141 <input checked="" type="checkbox"/> KB4141	 German standard socket 2 P+E 16 A 250 VA socket with earth side contacts - shielded tulip contacts - with screw terminals - 2 modules
<input type="checkbox"/> KW4141A <input checked="" type="checkbox"/> KG4141A <input type="checkbox"/> KM4141A <input checked="" type="checkbox"/> KC4141A <input checked="" type="checkbox"/> KS4141A <input checked="" type="checkbox"/> KB4141A	 As above - automatic clamps
<input type="checkbox"/> KW4141G <input checked="" type="checkbox"/> KG4141G <input type="checkbox"/> KM4141G <input checked="" type="checkbox"/> KC4141G <input checked="" type="checkbox"/> KS4141G <input checked="" type="checkbox"/> KB4141G	 German standard socket 2 P+E 16 A 250 VA socket with earth side contacts - shielded tulip contacts - with screw terminals - for Greece - 2 modules
<input type="checkbox"/> KW4141TR <input checked="" type="checkbox"/> KG4141TR <input type="checkbox"/> KM4141TR <input checked="" type="checkbox"/> KC4141TR <input checked="" type="checkbox"/> KS4141TR <input checked="" type="checkbox"/> KB4141TR	 German standard socket 2 P+E 16 A 250 VA socket with earth side contacts - shielded tulip contacts - with screw terminals - for Turkey - 2 modules







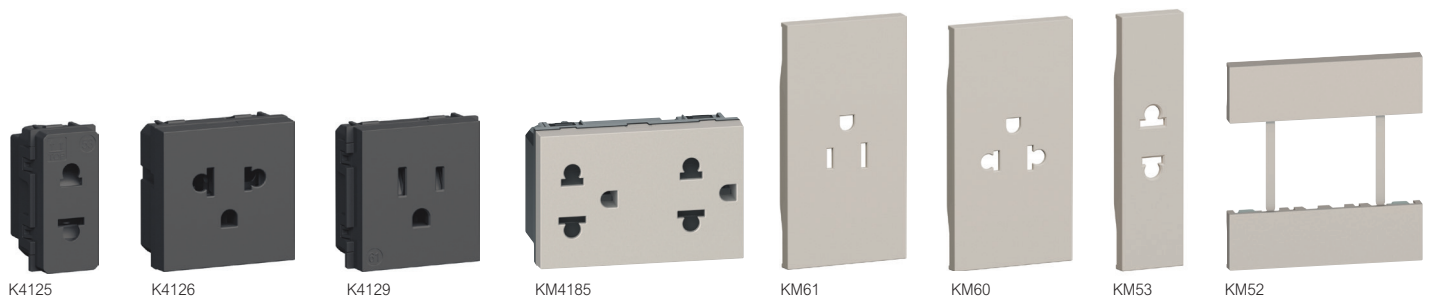





Item	Cover for german standard sockets
<input type="checkbox"/> KW04 <input checked="" type="checkbox"/> KG04 <input type="checkbox"/> KM04 <input checked="" type="checkbox"/> KR04 <input checked="" type="checkbox"/> KV04 <input checked="" type="checkbox"/> KC04 <input checked="" type="checkbox"/> KS04 <input checked="" type="checkbox"/> KB04	<b>2 modules</b>  Cover suitable for german standard sockets
<input type="checkbox"/> KW04P <input checked="" type="checkbox"/> KG04P <input type="checkbox"/> KM04P <input checked="" type="checkbox"/> KC04P <input checked="" type="checkbox"/> KS04P <input checked="" type="checkbox"/> KB04P	<b>2 modules with hatch</b>  Cover suitable for german standard sockets
<input type="checkbox"/> KW04M3 <input checked="" type="checkbox"/> KG04M3 <input type="checkbox"/> KM04M3 <input checked="" type="checkbox"/> KC04M3 <input checked="" type="checkbox"/> KS04M3 <input checked="" type="checkbox"/> KB04M3	<b>3 modules</b>  Cover suitable for german standard sockets

# Living Now standard electrical system

## European/american standard sockets



Devices to be completed with appropriate covers as indicated below



Item	European/american standard sockets	Item	Cover
○ K4125	 Euro american standard 2 P 16 A 127/250 VA socket - Ø 5 mm shielded tulip contacts - 1 modules	<input type="checkbox"/> KW53 <input type="checkbox"/> KG53 <input type="checkbox"/> KM53	<b>1 module</b>  Cover for item K4125
○ K4126	 Euro american standard 2 P+E 16 A 127/250 VA universal duplex socket - Ø 5 mm shielded tulip contacts - 2 modules	<input type="checkbox"/> KW60 <input type="checkbox"/> KG60 <input type="checkbox"/> KM60	<b>1 module</b>  Cover for item K4126
○ K4129	 American standard 2 P+E 15 A 127/250 VA socket - shielded tulip contacts - 1 modules	<input type="checkbox"/> KW61 <input type="checkbox"/> KG61 <input type="checkbox"/> KM61	<b>1 module</b>  Cover for item K4129
<input type="checkbox"/> KW4185 <input type="checkbox"/> KG4185 <input type="checkbox"/> KM4185	 Euro american standard 2 P+E 16 A 127/250 VA universal duplex socket - shielded tulip contacts - 3 modules	<input type="checkbox"/> KW60T <input type="checkbox"/> KG60T <input type="checkbox"/> KM60T	<b>2 modules</b>  Cover for item K4126T only for Thailand standard socket
<input type="checkbox"/> KW4188 <input type="checkbox"/> KG4188 <input type="checkbox"/> KM4188	 American standard 2 P+E 15 A 127/250 VA universal duplex socket - shielded tulip contacts - 3 modules	<input type="checkbox"/> KW52 <input type="checkbox"/> KG52 <input type="checkbox"/> KM52	<b>3 modules</b>  Cover for Item K..4185, K..4188, K..4185T
<input type="checkbox"/> KW4185T <input type="checkbox"/> KG4185T <input type="checkbox"/> KM4185T	 Thai standard 2 P+E 16 A 127/250 VA universal duplex socket - shielded tulip contacts - 3 modules	<input type="checkbox"/> KW52 <input type="checkbox"/> KG52 <input type="checkbox"/> KM52	
<input type="checkbox"/> KW4126T	 Thai standard 2 P+E 16 A 127/250 VA universal duplex socket - Ø 5 mm shielded tulip contacts - 2 modules		
<input type="checkbox"/> KW4185T <input type="checkbox"/> KG4185T <input type="checkbox"/> KM4185T	 Thai standard 2 P+E 16 A 127/250 VA universal duplex socket - shielded tulip contacts - 3 modules		

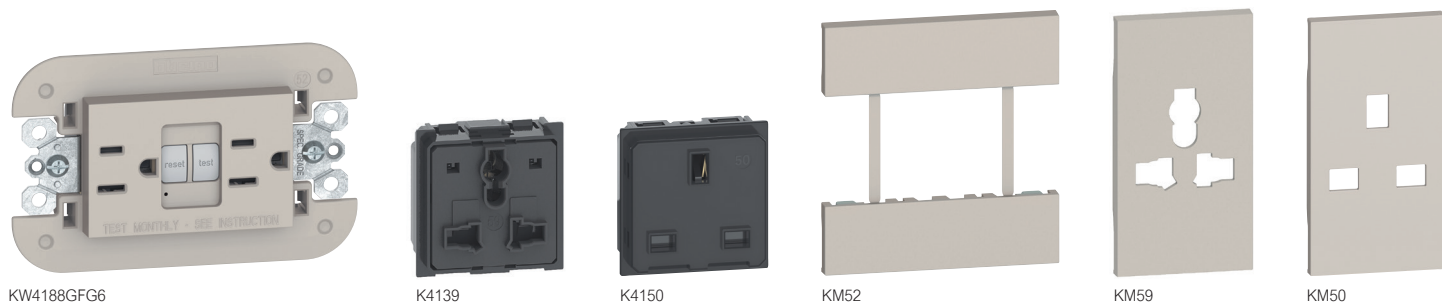

# Living Now standard electrical system

American, multistandard and british standard sockets



Devices to be completed with appropriate covers as indicated below

Item	American standard sockets
<input type="checkbox"/> KW4188GFG6	 American standard 2 P+E 15 A 127 VA GFCI socket - support frame included - 3 modules
<input type="checkbox"/> KG4188GFG6	
<input type="checkbox"/> KM4188GFG6	
<input type="checkbox"/> KC4188GFG6	
<input type="checkbox"/> KS4188GFG6	
<input type="checkbox"/> KB4188GFG6	
Item	Multistandard socket
<input type="checkbox"/> K4139	 Multistandard socket - 2 modules
Item	British standard sockets
<input type="checkbox"/> K4150	 2 P+E 13 A 250 Va.c. - 2 modules

Item	Cover for american standard sockets
<input type="checkbox"/> KW52	<b>3 modules</b>  Cover suitable for items K..4188GFG6
<input type="checkbox"/> KG52	
<input type="checkbox"/> KM52	
<input type="checkbox"/> KC52	
<input type="checkbox"/> KS52	
<input type="checkbox"/> KB52	
Item	Cover for multistandard socket
<input type="checkbox"/> KW59	<b>2 modules</b>  Cover suitable for item K4139
<input type="checkbox"/> KG59	
<input type="checkbox"/> KM59	
<input type="checkbox"/> KC59	
<input type="checkbox"/> KS59	
<input type="checkbox"/> KB59	
Item	Cover for british standard sockets
<input type="checkbox"/> KW50	<b>2 modules</b>  Cover for British standard sockets
<input type="checkbox"/> KG50	
<input type="checkbox"/> KM50	
<input type="checkbox"/> KC50	
<input type="checkbox"/> KS50	
<input type="checkbox"/> KB50	

# Living Now standard electrical system

## Israeli and Swiss standard sockets

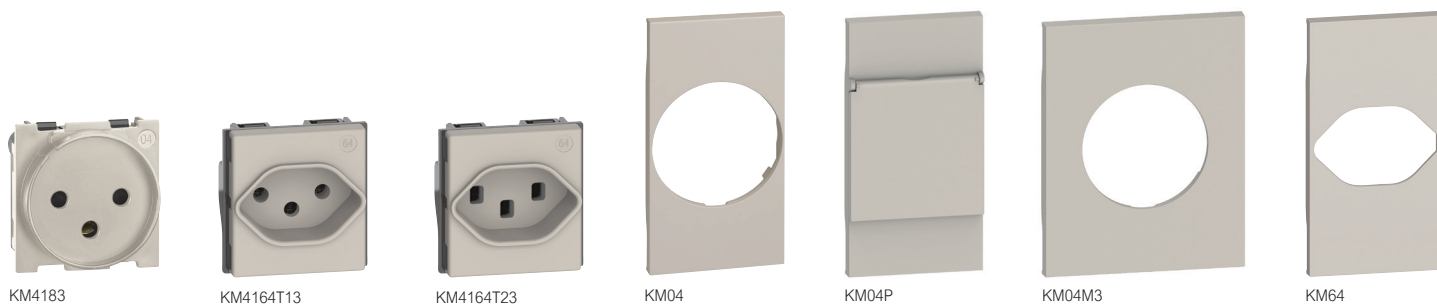

- Item
- KW4183
  - KG4183
  - KM4183
  - KC4183
  - KS4183
  - KB4183

### Israeli standard sockets

 2 P+E 10/16 A 250 Va.c. socket - 2 modules

- Item
- KW4164T13
  - KG4164T13
  - KM4164T13
  - KC4164T13
  - KS4164T13
  - KB4164T13
  - KW4164T23
  - KG4164T23
  - KM4164T23
  - KC4164T23
  - KS4164T23
  - KB4164T23

### Swiss standard sockets

 2 P+E 10 A 250 Va.c. socket - 2 modules

 2 P+E 16 A 250 Va.c. socket - 2 modules

- Item
- KW04
  - KG04
  - KM04
  - KC04
  - KS04
  - KB04

### Cover for israeli standard sockets

#### 2 modules

 Cover suitable for all the items K..4183

- Item
- KW04P
  - KG04P
  - KM04P
  - KC04P
  - KS04P
  - KB04P

#### 2 modules with hatch

 Cover suitable for all the items K..4183

- Item
- KW04M3
  - KG04M3
  - KM04M3
  - KC04M3
  - KS04M3
  - KB04M3

#### 3 modules

 Cover suitable for all the items K..4183

- Item
- KW64
  - KG64
  - KM64
  - KC64
  - KS64
  - KB64

### Cover for Swiss standard sockets

#### 2 modules

 Cover for Swiss standard sockets

# Living Now standard electrical system

French/belgian standard sockets, 2 modules, cover & Top FLAT socket version

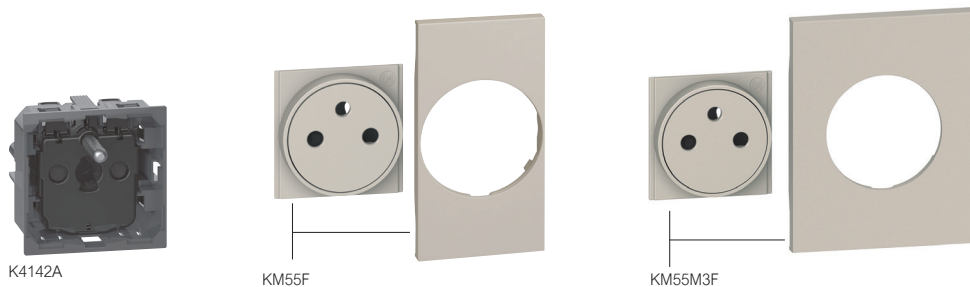

Devices to be completed with appropriate covers as indicated below

Item	French-Belgium standard sockets
○ K4142A	 French-Belgium standard socket 2 P+E 16 A 250 VA - automatic clamps - shielded tulip - 2 modules

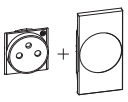
Item	Cover for FLAT socket version
<input type="checkbox"/> KW55F <input type="checkbox"/> KG55F <input type="checkbox"/> KM55F <input type="checkbox"/> KR55F <input type="checkbox"/> KV55F  <input type="checkbox"/> KC55F <input type="checkbox"/> KS55F <input type="checkbox"/> KB55F	<b>2 modules</b>  Cover for item K4142A (Red and green for special users)

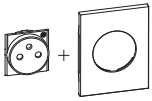
<input type="checkbox"/> KW55M3F <input type="checkbox"/> KG55M3F <input type="checkbox"/> KM55M3F  <input type="checkbox"/> KC55M3F <input type="checkbox"/> KS55M3F <input type="checkbox"/> KB55M3F	<b>3 modules</b>  Cover for item K4142A
--	---

**Note:** if replacing only the 3-module cover, order the following codes: KG/KM/KW04M3

## Example: function & cover colour choice



# Living Now standard electrical system

French/belgian standard sockets, 2 modules, cover & Top FLAT socket version

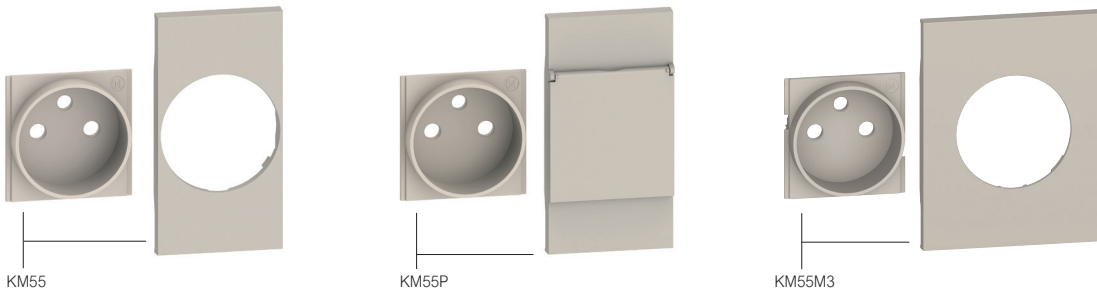

Devices to be completed with appropriate covers as indicated below

Item	French-Belgium standard sockets
○ K4142A	French-Belgium standard socket 2 P+E 16 A 250 VA - automatic clamps - shielded tulip - 2 modules
<b>Cover for STANDARD socket version</b> <b>2 modules</b> Cover for item K4142A (Red and green for special users)	
<input type="checkbox"/> KW55 <input checked="" type="checkbox"/> KG55 <input type="checkbox"/> KM55 <input checked="" type="checkbox"/> KR55 <input checked="" type="checkbox"/> KV55 <input checked="" type="checkbox"/> KC55 <input checked="" type="checkbox"/> KS55 <input checked="" type="checkbox"/> KB55	

Item	Cover for STANDARD socket version
<input type="checkbox"/> KW55P <input checked="" type="checkbox"/> KG55P <input type="checkbox"/> KM55P  <input checked="" type="checkbox"/> KC55P <input checked="" type="checkbox"/> KS55P <input checked="" type="checkbox"/> KB55P	<b>2 modules with hatch</b> Cover for item K4142A
<input type="checkbox"/> KW55M3 <input checked="" type="checkbox"/> KG55M3 <input type="checkbox"/> KM55M3  <input checked="" type="checkbox"/> KC55M3 <input checked="" type="checkbox"/> KS55M3 <input checked="" type="checkbox"/> KB55M3	<b>3 modules</b> Cover for item K4142A

**Note:** if replacing only the 3-module cover, order the following codes: KG/KM/KW04M3

## Example: function & cover colour choice





# Living Now standard electrical system

Indian, australian, chinese and brasilian standard sockets

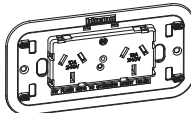

Devices to be completed with appropriate covers as indicated below

Item	Australian standard sockets
<input type="radio"/> K4132	 2P+E 10 A 250 VA Australian std. socket - safety socket SGPO, shuttered and auto switched - 2 modules
<input type="radio"/> K4134	 2P+E 10 A 250 VA Australian std. socket - duplex - 3 modules

Item	Brasilian standard socket
<input type="checkbox"/> KW4165F <input checked="" type="checkbox"/> KG4165F <input type="checkbox"/> KM4165F	 2P+E 10A 250VA flat brasilian std. socket - shuttered contact tubes - 1 module
<input checked="" type="checkbox"/> KC4165F <input checked="" type="checkbox"/> KS4165F <input checked="" type="checkbox"/> KB4165F	
<input type="checkbox"/> KW4166F <input checked="" type="checkbox"/> KG4166F <input type="checkbox"/> KM4166F	 2P+E 20A 250VA flat brasilian std. socket - shuttered contact tubes - 1 module
<input checked="" type="checkbox"/> KC4166F <input checked="" type="checkbox"/> KS4166F <input checked="" type="checkbox"/> KB4166F	

Item	Cover for australian standard sockets
<input type="checkbox"/> KW67 <input checked="" type="checkbox"/> KG67	<b>2 modules</b>  Cover for Item K4132
<input checked="" type="checkbox"/> KC67 <input checked="" type="checkbox"/> KS67 <input checked="" type="checkbox"/> KB67	

Item	(specific modularities)
<input type="checkbox"/> KW69 <input checked="" type="checkbox"/> KG69	 Cover for Item K4134
<input checked="" type="checkbox"/> KC69 <input checked="" type="checkbox"/> KS69 <input checked="" type="checkbox"/> KB69	

Item	Cover for brasilian standard sockets
<input type="checkbox"/> KW65 <input checked="" type="checkbox"/> KG65 <input type="checkbox"/> KM65	<b>1 module</b>  Cover for Item K..4165F, K..4166F
<input checked="" type="checkbox"/> KC65 <input checked="" type="checkbox"/> KS65 <input checked="" type="checkbox"/> KB65	

# Living Now standard electrical system

Indian, australian, chinese and brasilian standard sockets



K4181



K4189N



K4190N



K4139IN

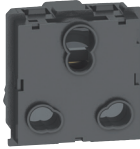

K4157



K4158



KG81



KG89N



KG89S



KG90N



KM59

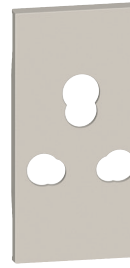

KM57

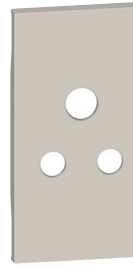

KM58

Devices to be completed with appropriate covers as indicated below

Item	China standard sockets
<input type="radio"/> K4181	2P+E 16A 250VA chinese std. socket - shuttered contact tubes - 2 modules
<input type="radio"/> K4189N	5P+E 10A 250VA chinese std. socket - shuttered contact tubes - 2 modules
<input type="radio"/> K4190N	2P 10A 250VA chinese std. socket - shuttered contact tubes - 1 module
<b>Indian standard socket</b>	
<input type="radio"/> K4139IN	Indian multistandard socket - 2 modules
<input type="radio"/> K4157	2P+E 6/16A 240VA Indian std. Combined socket - shuttered contact tubes - 2 modules
<input type="radio"/> K4158	2P+E 6A 240~ Indian std. universal socket - 2 modules

Item	Cover for chinese standard sockets
<input type="checkbox"/> KW81 <input checked="" type="checkbox"/> KG81	2 modules Cover for Item K4181
<input checked="" type="checkbox"/> KC81 <input checked="" type="checkbox"/> KS81 <input checked="" type="checkbox"/> KB81	
<input type="checkbox"/> KW89N <input checked="" type="checkbox"/> KG89N	2 modules Cover for Item K4189N
<input checked="" type="checkbox"/> KC89N <input checked="" type="checkbox"/> KS89N <input checked="" type="checkbox"/> KB89N	

Item	Cover for chinese standard sockets
<input type="checkbox"/> KW89S <input checked="" type="checkbox"/> KG89S	<b>2 modules</b> Cover for Item K4189N
<input checked="" type="checkbox"/> KC89S <input checked="" type="checkbox"/> KS89S <input checked="" type="checkbox"/> KB89S	
<input type="checkbox"/> KW90N <input checked="" type="checkbox"/> KG90N	<b>1 module</b> Cover for Item K4190N
<input checked="" type="checkbox"/> KC90N <input checked="" type="checkbox"/> KS90N <input checked="" type="checkbox"/> KB90N	







Item	Cover for indian standard sockets
<input type="checkbox"/> KW59 <input checked="" type="checkbox"/> KG59 <input type="checkbox"/> KM59	<b>2 modules</b> Cover for Item K4139IN
<input checked="" type="checkbox"/> KC59 <input checked="" type="checkbox"/> KS59 <input checked="" type="checkbox"/> KB59	
<input type="checkbox"/> KW57 <input checked="" type="checkbox"/> KG57 <input type="checkbox"/> KM57	Cover for Item K4157
<input checked="" type="checkbox"/> KC57 <input checked="" type="checkbox"/> KS57 <input checked="" type="checkbox"/> KB57	
<input type="checkbox"/> KW58 <input checked="" type="checkbox"/> KG58 <input type="checkbox"/> KM58	Cover for Item K4158
<input checked="" type="checkbox"/> KC58 <input checked="" type="checkbox"/> KS58 <input checked="" type="checkbox"/> KB58	

# Living Now standard electrical system

## USB and wireless chargers











Devices to be completed with appropriate covers as indicated below

Item	USB charger
<input type="radio"/> K4192AC	 USB charger with 2 type A and C ports for charging single electronic devices up to 15W or simultaneous charging of two devices. - 100-240 V 50-60 Hz DIRECT power supply Output voltage 5V - 1 module
<input type="radio"/> K4292AC	 USB charger with 2 type A and C ports for charging single electronic devices up to 20W or simultaneous charging of two devices. It allows the fast charge of portable devices (PC, tablets, smartphones) based on Power Delivery technology. - 100-240 V 50-60 Hz DIRECT power supply. Output voltage 5V - 2 modules
<input type="radio"/> K4192CC	 USB charger with 2 type C ports for charging single electronic devices up to 15W or simultaneous charging of two devices. - 100-240 V 50-60 Hz DIRECT power supply Output voltage 5V - 1 module
<input type="radio"/> K4292CC	 USB charger with 2 type C ports for charging single electronic devices up to 20W or simultaneous charging of two devices. It allows the fast charge of portable devices (PC, tablets, smartphones) based on Power Delivery technology. - 100-240 V 50-60 Hz DIRECT power supply. Output voltage 5V - 2 modules
<input type="radio"/> K4192C	 USB charger with 1 type C port for charging single electronic devices up to 20W. It allows the fast charge of portable devices (PC, tablets, smartphones) based on Power Delivery technology. - 100-240 V 50-60 Hz DIRECT power supply Output voltage 5 - 9 -12V - 1 module
<input type="radio"/> K4293CC	 Double USB socket - 2 x Type-C 30W. Fast charging suitable for laptops, tablets smartphones and powerbanks. For charging up to two portable devices. Fast charge feature: Power Delivery. Consumption in passive mode < 0,1 W - 2 modules

Item	USB charger
<input type="radio"/> K4294C	 Single USB sockets - 1 x Type-C 45W For fast charging of smartphones, tablets, powerbanks. Fast charge feature: Power Delivery. Consumption in passive mode < 0,1 W - 2 modules

### USB chargers selection table

	Single port	Double port		Double port	Single port
	Tipo C	Tipo A+C	Tipo C+C	Tipo C+C	Tipo C 45 W
					
					
Max Power per 1 device	20 W	20 W		30 W	45 W
Power Delivery 3.0	YES	YES		YES	YES
Quick Charge 3.0	YES	YES		YES	YES
Items	<input type="radio"/> K4192C	<input type="radio"/> K4192AC and K4992AC		<input type="radio"/> K4293CC	<input type="radio"/> K4294C



To be completed with the corresponding cover, in the desired color.



White (KW)  Black (KG)  Sand (KM)  Champagne (KC)  Steel (KS)  Bronze (KB)  Neutral item (K) (without cover)

# Living Now standard electrical system

## USB and wireless chargers



Item	Cover for USB charger
<ul style="list-style-type: none"> <li><input type="checkbox"/> KW11PD</li> <li><input checked="" type="checkbox"/> KG11PD</li> <li><input type="checkbox"/> KM11PD</li> <li><input checked="" type="checkbox"/> KC11PD</li> <li><input checked="" type="checkbox"/> KS11PD</li> <li><input checked="" type="checkbox"/> KB11PD</li> </ul>	<b>1 module</b>  Cover for item K4192C
<ul style="list-style-type: none"> <li><input type="checkbox"/> KW13PD</li> <li><input checked="" type="checkbox"/> KG13PD</li> <li><input type="checkbox"/> KM13PD</li> <li><input checked="" type="checkbox"/> KC13PD</li> <li><input checked="" type="checkbox"/> KS13PD</li> <li><input checked="" type="checkbox"/> KB13PD</li> </ul>	 Cover for item K4192AC, K4192CC



Item	Cover for USB charger
<ul style="list-style-type: none"> <li><input type="checkbox"/> KW12PD</li> <li><input checked="" type="checkbox"/> KG12PD</li> <li><input type="checkbox"/> KM12PD</li> <li><input checked="" type="checkbox"/> KC12PD</li> <li><input checked="" type="checkbox"/> KS12PD</li> <li><input checked="" type="checkbox"/> KB12PD</li> </ul>	<b>2 modules</b>  Covers for USB chargers items K4292AC, K4292CC, K4294C.
<ul style="list-style-type: none"> <li><input type="checkbox"/> KW14PD</li> <li><input checked="" type="checkbox"/> KG14PD</li> <li><input type="checkbox"/> KM14PD</li> <li><input checked="" type="checkbox"/> KC14PD</li> <li><input checked="" type="checkbox"/> KS14PD</li> <li><input checked="" type="checkbox"/> KB14PD</li> </ul>	 Cover for USB charger item K4293CC



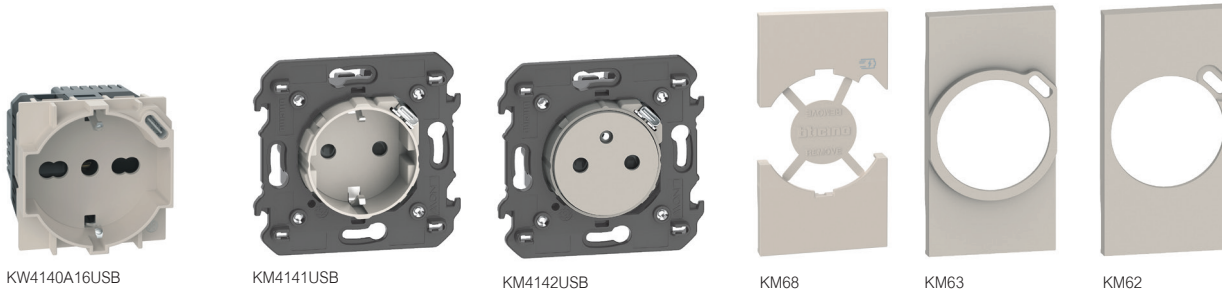



# Living Now standard electrical system

## USB charger with socket - French/belgian and German standard









Devices to be completed with appropriate covers as indicated below

Item	USB charger with socket outlet
<input type="checkbox"/> KW4140A16USB <input checked="" type="checkbox"/> KG4140A16USB <input type="checkbox"/> KM4140A16USB  <input checked="" type="checkbox"/> KC4140A16USB <input checked="" type="checkbox"/> KS4140A16USB <input checked="" type="checkbox"/> KB4140A16USB	 <p>Standard Italian P40 socket with integrated USB charger.                      2 P+E 16A 250 Va.c. socket - 19 mm and 26mm interaxis in two-centre configuration - protected sockets. Side earth contacts for German standard plugs.                      Suitable for:                      - Italian standard plugs 2 P and 2 P+E 10/16A                      - German standard plugs 2 P+E 16A                      USB type C Power Delivery socket max 18W for charging electronic devices up to 1500mA                      - 2 modules</p>
<input type="checkbox"/> KW4141USB <input checked="" type="checkbox"/> KG4141USB <input type="checkbox"/> KM4141USB  <input checked="" type="checkbox"/> KC4141USB <input checked="" type="checkbox"/> KS4141USB <input checked="" type="checkbox"/> KB4141USB	 <p>German standard electric socket with integrated USB charger.                      Socket 2 P+E 16 A 250 VA - protected tulip contacts - side earth contact.                      5 Vdc type C USB charger for charging electronic devices up to 7,5 W.                      Integrated with a 2-module support, it can be installed instead of an existing socket in a 40 mm deep box.                      Screw fixing and connection using automatic clamps</p>
<input type="checkbox"/> KW4142USB <input checked="" type="checkbox"/> KG4142USB <input type="checkbox"/> KM4142USB  <input checked="" type="checkbox"/> KC4142USB <input checked="" type="checkbox"/> KS4142USB <input checked="" type="checkbox"/> KB4142USB	 <p>French/belgian standard flat electric socket with integrated USB charger.                      Socket 2 P+E 16 A 250 VA - protected tulip contacts.                      When the plug is inserted the socket surface slides inside the casing; it returns to its initial position when the plug is taken out.                      5 Vdc type C USB charger for charging electronic devices up to 7,5 W.                      Integrated with a 2-module support, it can be installed instead of an existing socket in a 40 mm deep box.                      Screw fixing and connection using automatic clamps</p>

Item	Cover
<input type="checkbox"/> KW68 <input checked="" type="checkbox"/> KG68 <input type="checkbox"/> KM68  <input checked="" type="checkbox"/> KC68 <input checked="" type="checkbox"/> KS68 <input checked="" type="checkbox"/> KB68	<p><b>2 modules</b></p>  <p>Covers for items KW4140A16USB, KG4140A16USB, KM4140A16USB</p>  <p>Covers for items KC4140A16USB, KS4140A16USB, KB4140A16USB</p>
<input type="checkbox"/> KW63 <input checked="" type="checkbox"/> KG63 <input type="checkbox"/> KM63  <input checked="" type="checkbox"/> KC63 <input checked="" type="checkbox"/> KS63 <input checked="" type="checkbox"/> KB63	 <p>Cover for items KW4141USB, KG4141USB, KM4141USB</p>  <p>Covers for items KC4141USB, KS4141USB, KB4141USB</p>
<input type="checkbox"/> KW62 <input checked="" type="checkbox"/> KG62 <input type="checkbox"/> KM62  <input checked="" type="checkbox"/> KC62 <input checked="" type="checkbox"/> KS62 <input checked="" type="checkbox"/> KB62	 <p>Cover for items KW4142USB, KG4142USB, KM4142USB</p>  <p>Covers for items KC4142USB, KS4142USB, KB4142USB</p>

### USB chargers selection table

	Single port with socket outlet		
	Type C	Type C	Type C
			
			
Max Power per 1 device	18 W	7,5 W	7,5 W
Power Delivery 3.0	YES	NO	NO
Quick Charge 3.0	NO	NO	NO
Items	K...4140A16USB	K...4141USB	K...4142USB

Complete the code with the letter corresponding to the desired color and the related cover.

White (KW)  
  Black (KG)  
  Sand (KM)  
  Champagne (KC)  
  Steel (KS)  
  Bronze (KB)  
  Neutral item (K) (without cover)

# Living Now standard electrical system

## USB charger with socket



KM4185AA



KM4185AC





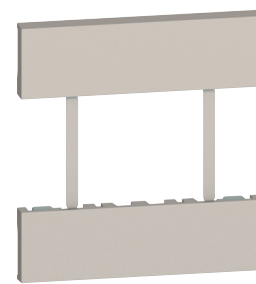

KM4188AC

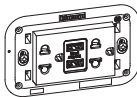

KM52

Devices to be completed with appropriate covers as indicated below









Item	USB charger with socket european/american std.	Item	Cover for USB charger with socket european/american std.
<input type="checkbox"/> KW4185AA <input checked="" type="checkbox"/> KG4185AA <input type="checkbox"/> KM4185AA  <input checked="" type="checkbox"/> KC4185AA <input checked="" type="checkbox"/> KS4185AA <input checked="" type="checkbox"/> KB4185AA	 <p>Euro american standard 2 P+E 16 A 127/250 VA universal duplex socket - shielded tulip contacts. 5 Vdc type A USB charger for quick charge of one single electronic device up to 3,100 mA or simultaneous charging of two devices up to 1,500 mA - 110-230 V 50-60 Hz DIRECT power supply - 3 modules</p>	<input type="checkbox"/> KW52 <input checked="" type="checkbox"/> KG52 <input type="checkbox"/> KM52  <input checked="" type="checkbox"/> KC52 <input checked="" type="checkbox"/> KS52 <input checked="" type="checkbox"/> KB52	<p><b>2 modules</b></p>  <p>Cover for Item KW4185AA, KW4185AC, KW4188AA, KW4188AC Cover for Item KG4185AA, KG4185AC, KG4188AA, KG4188AC Cover for Item KM4185AA, KM4185AC, KM4188AA, KM4188AC Cover for Item KC4185AA, KC4185AC, KC4188AA, KC4188AC Cover for Item KS4185AA, KS4185AC, KS4188AA, KS4188AC Cover for Item KB4185AA, KB4185AC, KB4188AA, KB4188AC</p>
<input type="checkbox"/> KW4185AC <input checked="" type="checkbox"/> KG4185AC <input type="checkbox"/> KM4185AC  <input checked="" type="checkbox"/> KC4185AC <input checked="" type="checkbox"/> KS4185AC <input checked="" type="checkbox"/> KB4185AC	 <p>Euro american standard 2 P+E 16 A 127/250 VA universal duplex socket - shielded tulip contacts. 5 Vdc type A and C USB charger for quick charge of single electronic devices up to 3,100 mA or simultaneous charging of two devices up to 1,500 mA - 110-230 V 50-60 Hz DIRECT power supply - 3 modules</p>		
<input type="checkbox"/> KW4188AA <input checked="" type="checkbox"/> KG4188AA <input type="checkbox"/> KM4188AA  <input checked="" type="checkbox"/> KC4188AA <input checked="" type="checkbox"/> KS4188AA <input checked="" type="checkbox"/> KB4188AA	 <p>American standard 2 P+E 15 A 127/250 VA universal duplex socket - shielded tulip contacts. 5 Vdc type A USB charger for quick charge of one single electronic device up to 3,100 mA or simultaneous charging of two devices up to 1,500 mA - 110-230 V 50-60 Hz DIRECT power supply - 3 modules</p>		
<input type="checkbox"/> KW4188AC <input checked="" type="checkbox"/> KG4188AC <input type="checkbox"/> KM4188AC  <input type="checkbox"/> KC4188AC <input checked="" type="checkbox"/> KS4188AC <input type="checkbox"/> KB4188AC	 <p>American standard 2 P+E 15 A 127/250 VA universal duplex socket - shielded tulip contacts. 5 Vdc type A and C USB charger for quick charge of single electronic devices up to 3,100 mA or simultaneous charging of two devices up to 1,500 mA - 110-230 V 50-60 Hz DIRECT power supply - 3 modules</p>		

# Living Now standard electrical system

## TV sockets



Devices to be completed with appropriate covers as indicated below

Item	TV socket 1 module	Item	Cover for TV socket 1 module
<input type="radio"/> K4202D	 Direct coaxial socket for single-user aerial systems, including central remote powered systems and single-user central satellite systems with current and signal transfer for the selection of the channels - shielded connection clamps with captive screws - Diam. 9.5 mm - male connector - 1 module	<input type="checkbox"/> KW08 <input type="checkbox"/> KG08 <input type="checkbox"/> KM08	<b>1 module</b>  Cover for item K4202D, K4202P14, K4202P10, K4202F and K4202CN
<input type="radio"/> K4202CN	 Chinese TV socket - 1 module	<input type="checkbox"/> KC08 <input type="checkbox"/> KS08 <input type="checkbox"/> KB08	
<input type="radio"/> K4202P14	 Passthrough coaxial socket, -14 dB attenuation, for centralised aerial systems, including central remote powered systems and centralised satellite systems with current and signal transfer for the selection of the channels - shielded connection clamps with captive screws - Diam. 9.5 mm - male connector - 1 module	<input type="checkbox"/> KW09 <input type="checkbox"/> KG09 <input type="checkbox"/> KM09	 Cover for item K4214D
<input type="radio"/> K4202P10	 Terminal passthrough coaxial socket, 10dB attenuation, for centralised aerial systems, including central remote powered systems and centralised satellite systems with current and signal transfer for the selection of the channels; shielded connection clamps with captive screws - Diam. 9.5 mm - male connector - 75 Ω incorporated impedance final adapter - 1 module	<input type="checkbox"/> KC09 <input type="checkbox"/> KS09 <input type="checkbox"/> KB09	
<input type="radio"/> K4202F	 Type F TV coaxial connector - impedance 75 Ω - screw hook - 1 module	<input type="checkbox"/> KW08M2 <input type="checkbox"/> KG08M2 <input type="checkbox"/> KM08M2	<b>2 modules</b>  Cover for item K4202D, K4202P14, K4202P10 and K4202F
<input type="radio"/> K4214D	 Direct demixed coaxial socket for single-user aerial systems, also remote powered and shunting centralised and for single-user / shunting centralised satellite systems with current and signal transfer for the selection of the channels, Ø 9.5 mm male TV connector - type F SAT connector - 1 module	<input type="checkbox"/> KC08M2 <input type="checkbox"/> KS08M2 <input type="checkbox"/> KB08M2	

# Living Now standard electrical system

## TV sockets



Devices to be completed with appropriate covers as indicated below







Item	TV socket 2 modules	Item	Cover for TV socket 2 modules	
○ K4211M2C	TV-RD socket for cable operator - Double coaxial shunted socket for TV and FM-LMC reception - Ø 9,5mm - Belgium (Telenet operator) - 2 modules	<input type="checkbox"/> KW25M2 <input type="checkbox"/> KG25M2 <input type="checkbox"/> KM25M2  <input type="checkbox"/> KC25M2 <input type="checkbox"/> KS25M2 <input type="checkbox"/> KB25M2	Cover for item K4211M2C, K4217M2D, K4217M2P14, K4217M2P10 and K4214M2D	
○ K4217M2D	Star demixed TV-SAT sockets for DVB-T, cablecast and satellite installation UHD TV, 4GLTE compatible. For distribution of TV & Radio signals. Recommended coaxial cable: 17 VATC - Meet EN 50083 and EN 50083-2 European directive. - TV male connector (Ø9.5 mm) - SAT F type connector - TV: 5-68/120-862 MHz; R: 87.5 - 108 MHz; - SAT: 950-2400 MHz - attenuation 1.5 dB - 2 modules			
○ K4217M2P14	Passthrough demixed TV-SAT sockets for DVB-T, cablecast and satellite installation UHD TV, 4GLTE compatible. For distribution of TV & Radio signals. Meet EN 50083 and EN 50083-2 European directive - TV male connector (Ø9.5 mm) - SAT F type connector - TV: 5-68/120-862 MHz; R: 87.5 - 108 MHz; - SAT: 950-2400 MHz - attenuation 14 dB - 2 modules			
○ K4217M2P10	Terminal demixed TV-SAT sockets for DVB-T, cablecast and satellite installation UHD TV, 4GLTE compatible. For distribution of TV & Radio signals. Meet EN 50083 and EN 50083-2 European directive - TV male connector (Ø9.5 mm) - SAT F type connector - TV: 5-68/120-862 MHz; R: 87.5 - 108 MHz; - SAT: 950-2400 MHz - attenuation 10 dB - 2 modules		<input type="checkbox"/> KW26M2 <input type="checkbox"/> KG26M2 <input type="checkbox"/> KM26M2  <input type="checkbox"/> KC26M2 <input type="checkbox"/> KS26M2 <input type="checkbox"/> KB26M2	Cover for item K4210M2D
○ K4210M2D	Star demixed TV-R-SAT sockets for DVB-T, cablecast and satellite installation UHD TV, 4GLTE compatible. For distribution of TV & Radio signals. Recommended coaxial cable: 17 VATC - Meet EN 50083 and EN 50083-2 European directive. - TV male connector (Ø 9.5 mm) - R female connector (Ø9.5 mm) - SAT F type connector - TV: 5-68/120-862 MHz; R: 87.5 - 108 MHz; - SAT: 950-2400 MHz - attenuation 1.5 dB - 2 modules			
○ K4214M2D	Direct demixed coaxial socket for singleuser aerial systems, also remote powered and shunting centralised and for single-user / shunting centralised satellite systems with current and signal transfer for the selection of the channels, Ø 9.5 mm male TV connector - type F SAT connector - 2 module		<input type="checkbox"/> KW4212 <input type="checkbox"/> KG4212 <input type="checkbox"/> KM4212  <input type="checkbox"/> KC4212 <input type="checkbox"/> KS4212 <input type="checkbox"/> KB4212	<input type="checkbox"/> Cover for TV-SAT sockets



# Living Now standard electrical system

RJ connectors for data, telephony and for optical fiber



Devices to be completed with appropriate covers as indicated below

Item	RJ45 connectors	
Connectors for data/telephony transmission These connectors can be used for 4-pair signal transmission systems - 1 module		
<input type="checkbox"/> KW4279C5E <input checked="" type="checkbox"/> KG4279C5E <input type="checkbox"/> KM4279C5E <input checked="" type="checkbox"/> KC4279C5E <input checked="" type="checkbox"/> KS4279C5E <input checked="" type="checkbox"/> KB4279C5E	 Category 5E UTP	Type of connection TOOLLESS IDC
<input type="checkbox"/> KW4279C6 <input checked="" type="checkbox"/> KG4279C6 <input type="checkbox"/> KM4279C6 <input checked="" type="checkbox"/> KC4279C6 <input checked="" type="checkbox"/> KS4279C6 <input checked="" type="checkbox"/> KB4279C6	 Category 6 UTP	Type of connection TOOLLESS IDC
<input type="checkbox"/> KW4279C6F <input checked="" type="checkbox"/> KG4279C6F <input type="checkbox"/> KM4279C6F <input checked="" type="checkbox"/> KC4279C6F <input checked="" type="checkbox"/> KS4279C6F <input checked="" type="checkbox"/> KB4279C6F	 Category 6 FTP	Type of connection TOOLLESS IDC
<input type="checkbox"/> KW4279C6S <input checked="" type="checkbox"/> KG4279C6S <input type="checkbox"/> KM4279C6S <input checked="" type="checkbox"/> KC4279C6S <input checked="" type="checkbox"/> KS4279C6S <input checked="" type="checkbox"/> KB4279C6S	 Category 6 STP	Type of connection TOOLLESS IDC
<input type="checkbox"/> KW4279C6A <input checked="" type="checkbox"/> KG4279C6A <input type="checkbox"/> KM4279C6A <input checked="" type="checkbox"/> KC4279C6A <input checked="" type="checkbox"/> KS4279C6A <input checked="" type="checkbox"/> KB4279C6A	 Category 6A UTP	Type of connection TOOLLESS IDC
<input type="checkbox"/> KW4279C6AS <input checked="" type="checkbox"/> KG4279C6AS <input type="checkbox"/> KM4279C6AS <input checked="" type="checkbox"/> KC4279C6AS <input checked="" type="checkbox"/> KS4279C6AS <input checked="" type="checkbox"/> KB4279C6AS	 Category 6A STP	Type of connection TOOLLESS IDC

Item	Cover
<input type="checkbox"/> KW07 <input checked="" type="checkbox"/> KG07 <input type="checkbox"/> KM07 <input checked="" type="checkbox"/> KC07 <input checked="" type="checkbox"/> KS07 <input checked="" type="checkbox"/> KB07	<b>1 module</b>  Cover for all the RJ45
<input type="checkbox"/> KW07M2 <input checked="" type="checkbox"/> KG07M2 <input type="checkbox"/> KM07M2 <input checked="" type="checkbox"/> KC07M2 <input checked="" type="checkbox"/> KS07M2 <input checked="" type="checkbox"/> KB07M2	<b>2 modules</b>  Cover for all the RJ45

# Living Now standard electrical system

## RJ connectors for data, telephony and for optical fiber



Devices to be completed with appropriate covers as indicated below

Item	Connectors RJ11				
<input type="checkbox"/> KW4258RJ11 <input checked="" type="checkbox"/> KG4258RJ11 <input type="checkbox"/> KM4258RJ11 <input checked="" type="checkbox"/> KC4258RJ11 <input checked="" type="checkbox"/> KS4258RJ11 <input checked="" type="checkbox"/> KB4258RJ11	<p>These connectors are designed to meet the needs linked with telephonic interconnections - 1 module</p> <table border="1"> <thead> <tr> <th>Category</th> <th>Type of connection</th> </tr> </thead> <tbody> <tr> <td>RJ11</td> <td>K10</td> </tr> </tbody> </table>	Category	Type of connection	RJ11	K10
Category	Type of connection				
RJ11	K10				

<input type="radio"/> K4238	<p><b>Telephone socket standard BS</b></p> <p>Telephone socket standard BS - 1 module</p>
-----------------------------	---

<input type="radio"/> K4268SCA2	<p><b>Connector for optical fiber</b></p> <p>Fiber optic socket with SC/APC. Singlemode APC connector. Used to connect 1 fiber (fitted with connectors)</p>
---------------------------------	---

Item	KEYSTONE
<input type="checkbox"/> KW07K <input checked="" type="checkbox"/> KG07K <input type="checkbox"/> KM07K <input checked="" type="checkbox"/> KC07K <input checked="" type="checkbox"/> KS07K <input checked="" type="checkbox"/> KB07K	<p>Keystone connectors adapter - 1 module</p>

Item	Cover
<input type="checkbox"/> KW07 <input checked="" type="checkbox"/> KG07 <input type="checkbox"/> KM07 <input checked="" type="checkbox"/> KC07 <input checked="" type="checkbox"/> KS07 <input checked="" type="checkbox"/> KB07	<p><b>1 module</b></p> <p>Cover for all the RJ11</p>

<input type="checkbox"/> KW07M2 <input checked="" type="checkbox"/> KG07M2 <input type="checkbox"/> KM07M2 <input checked="" type="checkbox"/> KC07M2 <input checked="" type="checkbox"/> KS07M2 <input checked="" type="checkbox"/> KB07M2	<p><b>2 modules</b></p> <p>Cover for all the RJ11</p>
--	---

<input type="checkbox"/> KW20 <input checked="" type="checkbox"/> KG20 <input type="checkbox"/> KM20 <input checked="" type="checkbox"/> KC20 <input checked="" type="checkbox"/> KS20 <input checked="" type="checkbox"/> KB20	<p><b>Cover for telephone socket standard BS</b></p> <p><b>2 modules</b></p> <p>Cover for item K4238</p>
--	--

<input type="checkbox"/> KW13M2 <input checked="" type="checkbox"/> KG13M2 <input type="checkbox"/> KM13M2 <input checked="" type="checkbox"/> KC13M2 <input checked="" type="checkbox"/> KS13M2 <input checked="" type="checkbox"/> KB13M2	<p><b>Cover for optical fiber connector</b></p> <p><b>2 modules</b></p> <p>Cover for item K4268SCA2</p>
--	---

# Living Now standard electrical system

## Audio video connectors



Devices to be completed with appropriate covers as indicated below

Item	Audio Connector
<input type="checkbox"/> KW4269R <input checked="" type="checkbox"/> KG4269R <input type="checkbox"/> KM4269R <input checked="" type="checkbox"/> KC4269R <input checked="" type="checkbox"/> KS4269R <input checked="" type="checkbox"/> KB4269R	Double RCA module - 1 module
<input type="checkbox"/> KW4294 <input checked="" type="checkbox"/> KG4294 <input type="checkbox"/> KM4294 <input checked="" type="checkbox"/> KC4294 <input checked="" type="checkbox"/> KS4294 <input checked="" type="checkbox"/> KB4294	Home cinema speaker connector - 1 module
<input type="checkbox"/> K4284P <input type="checkbox"/> K4285P	Pre-connected HDMI 1.4 connector - 1 module  Pre-connected type A USB connector - 1 module













Item	Cover
<input type="checkbox"/> KW07 <input checked="" type="checkbox"/> KG07 <input type="checkbox"/> KM07 <input checked="" type="checkbox"/> KC07 <input checked="" type="checkbox"/> KS07 <input checked="" type="checkbox"/> KB07	<b>1 module</b> Cover for item KW4269R, KG4269R, KM4269R, KW4294, KG4294 and KM4294  Cover for item KC4269R, KS4269R, KB4269R, KC4294, KS4294 and KB4294
<input type="checkbox"/> KW14 <input checked="" type="checkbox"/> KG14 <input type="checkbox"/> KM14 <input checked="" type="checkbox"/> KC14 <input checked="" type="checkbox"/> KS14 <input checked="" type="checkbox"/> KB14	Cover for item K4284P
<input type="checkbox"/> KW10P <input checked="" type="checkbox"/> KG10P <input type="checkbox"/> KM10P <input checked="" type="checkbox"/> KC10P <input checked="" type="checkbox"/> KS10P <input checked="" type="checkbox"/> KB10P	Cover for item K4285P
<input type="checkbox"/> KW07M2 <input checked="" type="checkbox"/> KG07M2 <input type="checkbox"/> KM07M2 <input checked="" type="checkbox"/> KC07M2 <input checked="" type="checkbox"/> KS07M2 <input checked="" type="checkbox"/> KB07M2	<b>2 modules</b> Cover for item KW4269R, KG4269R, KM4269R, KW4294, KG4294 and KM4294  Cover for item KC4269R, KS4269R, KB4269R, KC4294, KS4294 and KB4294

# Living Now standard electrical system

## luminous and audible notification



Devices to be completed with appropriate covers as indicated below

Item	Bells and buzzer	Item	Cover for bell and buzzer	
○ K4351V230 ○ K4351V127 ○ K4351V12 ○ K4355V12 ○ K4356V230 ○ K4356V127 ○ K4356V12	<b>Bells</b>  230 VA bronze bell - 12 VA - 80 dB - 1 module  127 VA bronze bell - 8 VA - 80 dB - 1 module  12 VA bronze bell - 8 VA - 80 dB - 1 module  Electronic bell - 3 different sounds - with front volume adjustment - 12 Va.c.-d.c. power supply - 2 modules	<input type="checkbox"/> KW15 <input checked="" type="checkbox"/> KG15 <input type="checkbox"/> KM15  <input checked="" type="checkbox"/> KC15 <input checked="" type="checkbox"/> KS15 <input checked="" type="checkbox"/> KB15	<b>1 module</b>  Cover for item K4351V230, K4351V127, K4351V12, K4356V230, K4356V127 and K4356V12	
	<b>Buzzer</b>  230 VA buzzer - 12 VA - 80 dB - 1 module  127 VA buzzer - 12 VA - 80 dB - 1 module  12 VA buzzer - 12 VA - 80 dB - 1 module		<input type="checkbox"/> KW15M2 <input checked="" type="checkbox"/> KG15M2 <input type="checkbox"/> KM15M2  <input checked="" type="checkbox"/> KC15M2 <input checked="" type="checkbox"/> KS15M2 <input checked="" type="checkbox"/> KB15M2	<b>2 modules</b>  Cover for item K4355V12
	<b>Pilot lamp</b>  Lampholder for pilot lamp with transparent diffuser, to be completed with LED item K4743V230 (white) and/or item K4743V230R (red). Two operating mode: - 1 luminous signaling (to be completed with cover KW/KG/KM/KC/KS/KB08) - 2 luminous signaling (to be completed with cover KW/KG/KM/KC/KS/KB09)		<input type="checkbox"/> KW08 <input checked="" type="checkbox"/> KG08 <input type="checkbox"/> KM08  <input checked="" type="checkbox"/> KC08 <input checked="" type="checkbox"/> KS08 <input checked="" type="checkbox"/> KB08	<b>1 module</b>  Cover for item K4371 (one luminous signal)
			<input type="checkbox"/> KW09 <input checked="" type="checkbox"/> KG09 <input type="checkbox"/> KM09  <input checked="" type="checkbox"/> KC09 <input checked="" type="checkbox"/> KS09 <input checked="" type="checkbox"/> KB09	 Cover for item K4371 (two luminous signals)

# Living Now standard electrical system

functions for hotel room



K4549  
K4548



K4027H  
K4027V127H



K4373



K4192AC



K4192CC



K4192C











K4294C







KM4177

Devices to be completed with appropriate covers as indicated below

Item	Key card switches
<input type="radio"/> K4549	 Key card switch for the power supply inside the hotel room - slot light with built-in lamp - 30 second switch-off delay - power supply 230 VA. The completion of the light point requires two "half-module blanking modules" (item K4949) at the sides of the badge holder.
<input type="radio"/> K4548	 Key card switch for the power supply inside the hotel room - slot light with built-in lamp - 30 second switch-off delay - power supply 230 VA - with RFID technology recognition. The completion of the light point requires two "half-module blanking modules" (item K4949) at the sides of the badge holder.

Item	USB charger
<input type="radio"/> K4192AC	 USB charger with 2 type A and C ports for charging single electronic devices up to 15W or simultaneous charging of two devices. - 100-240 V 50-60 Hz DIRECT power supply. Output voltage 5V - 1 module
<input type="radio"/> K4292AC	 USB charger with 2 type A and C ports for charging single electronic devices up to 20W or simultaneous charging of two devices. It allows the fast charge of portable devices (PC, tablets, smartphones) based on Power Delivery technology. - 100-240 V 50-60 Hz DIRECT power supply. Output voltage 5V - 2 modules
<input type="radio"/> K4192CC	 USB charger with 2 type C ports for charging single electronic devices up to 15W or simultaneous charging of two devices. - 100-240 V 50-60 Hz DIRECT power supply. Output voltage 5V - 1 module
<input type="radio"/> K4292CC	 USB charger with 2 type C ports for charging single electronic devices up to 20W or simultaneous charging of two devices. It allows the fast charge of portable devices (PC, tablets, smartphones) based on Power Delivery technology. - 100-240 V 50-60 Hz DIRECT power supply. Output voltage 5V - 2 modules
<input type="radio"/> K4192C	 USB charger with 1 type C port for charging single electronic devices up to 20W. It allows the fast charge of portable devices (PC, tablets, smartphones) based on Power Delivery technology. - 100-240 V 50-60 Hz DIRECT power supply. Output voltage 5 - 9 - 12V - 1 module
<input type="radio"/> K4293CC	 Double USB socket - 2 x Type-C 30W. Fast charging suitable for laptops, tablets, smartphones and powerbanks. For charging up to two portable devices. Fast charge feature: Power Delivery. Consumption in passive mode < 0,1 W - 2 modules
<input type="radio"/> K4294C	 Single USB sockets - 1 x Type-C 45W For fast charging of smartphones, tablets, powerbanks. Fast charge feature: Power Delivery. Consumption in passive mode < 0,1 W - 2 modules

Item	Off-door controls
<input type="radio"/> K4027H	 1P 10 AX, 250 VA changeover switch, double-key 1-0-2 for Hotel, LIT - 1 module (The LED is replaceable with item K4743V230RG)
<input type="radio"/> K4027V127H	 As above, 127 VA (The LED is replaceable with item K4373V127RG)
<input type="radio"/> K4373	 Lampholder with two built-in LEDs, green and red. Can be used as out of room visual signal with double notification: do not disturb and make up the room - The LEDs cannot be replaced - 127/ 230 VA power supply - 1 module





Item	Shaver sockets
<input type="checkbox"/> KW4177	 Shaver socket with insulation transformer - input voltage 230 VA 50/60 Hz - output voltage 115/230 VA 20 VA. The cover of the selected colour is supplied in the same box as the shaver socket - 3 modules
<input type="checkbox"/> KG4177	
<input type="checkbox"/> KM4177	
<input type="checkbox"/> KC4177	
<input type="checkbox"/> KS4177	
<input type="checkbox"/> KB4177	

# Living Now standard electrical system





## functions for hotel room



**Cover for functions for hotel**

Item	1 module
<input type="checkbox"/> KW06H <input checked="" type="checkbox"/> KG06H <input type="checkbox"/> KM06H  <input checked="" type="checkbox"/> KC06H <input checked="" type="checkbox"/> KS06H <input checked="" type="checkbox"/> KB06H	 Cover for item K4027H and K4027V127H
<input type="checkbox"/> KW11H <input checked="" type="checkbox"/> KG11H <input type="checkbox"/> KM11H  <input checked="" type="checkbox"/> KC11H <input checked="" type="checkbox"/> KS11H <input checked="" type="checkbox"/> KB11H	 Cover for item K4373
<input type="checkbox"/> KW22M2 <input checked="" type="checkbox"/> KG22M2 <input type="checkbox"/> KM22M2  <input checked="" type="checkbox"/> KC22M2 <input checked="" type="checkbox"/> KS22M2 <input checked="" type="checkbox"/> KB22M2	<b>2 modules</b>  Cover for item K4549 et K4548
<input type="checkbox"/> KW22 <input checked="" type="checkbox"/> KG22 <input type="checkbox"/> KM22  <input checked="" type="checkbox"/> KC22 <input checked="" type="checkbox"/> KS22 <input checked="" type="checkbox"/> KB22	<b>3 modules</b>  Cover for item K4549 et K4548



**Cover for USB charger**

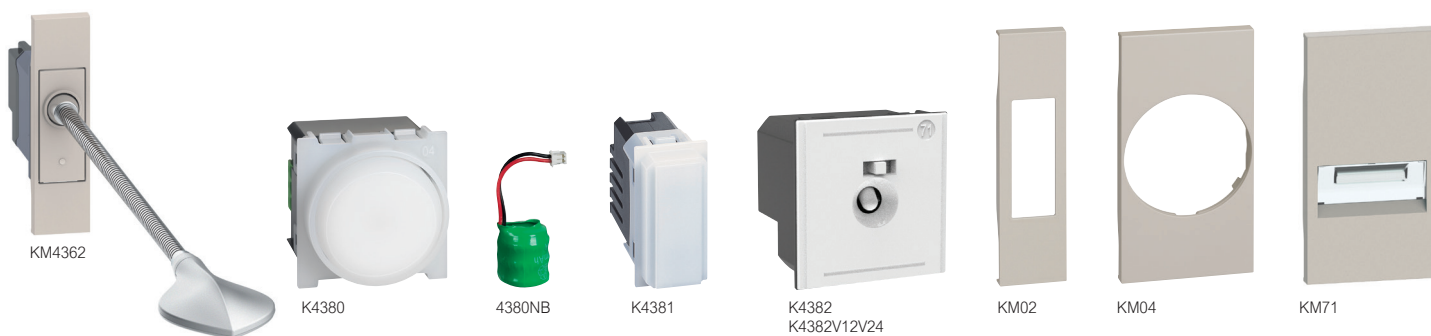

Item	1 module
<input type="checkbox"/> KW11PD <input checked="" type="checkbox"/> KG11PD <input type="checkbox"/> KM11PD  <input checked="" type="checkbox"/> KC11PD <input checked="" type="checkbox"/> KS11PD <input checked="" type="checkbox"/> KB11PD	 Cover for item K4192C
<input type="checkbox"/> KW13PD <input checked="" type="checkbox"/> KG13PD <input type="checkbox"/> KM13PD  <input checked="" type="checkbox"/> KC13PD <input checked="" type="checkbox"/> KS13PD <input checked="" type="checkbox"/> KB13PD	 Cover for item K4192AC, K4192CC
<input type="checkbox"/> KW12PD <input checked="" type="checkbox"/> KG12PD <input type="checkbox"/> KM12PD  <input checked="" type="checkbox"/> KC12PD <input checked="" type="checkbox"/> KS12PD <input checked="" type="checkbox"/> KB12PD	<b>2 modules</b>  Covers for items K4292AC, K4292CC, K4294C.
<input type="checkbox"/> KW14PD <input checked="" type="checkbox"/> KG14PD <input type="checkbox"/> KM14PD  <input checked="" type="checkbox"/> KC14PD <input checked="" type="checkbox"/> KS14PD <input checked="" type="checkbox"/> KB14PD	 Cover for USB charger item K4293CC





Devices to be completed with appropriate covers as indicated below

Item	Reading lamp
<input type="checkbox"/> KW4362 <input checked="" type="checkbox"/> KG4362 <input type="checkbox"/> KM4362  <input checked="" type="checkbox"/> KC4362 <input checked="" type="checkbox"/> KS4362 <input checked="" type="checkbox"/> KB4362	 <p>It is installed at the bedhead giving directional lighting. It has a flexible arm so that the lighting arm can be directed. The brightness can be dimmed by pressing the integrated ON/OFF control for a long time. It can also be connected to a remote control and, if necessary, the integrated control can be disabled with a 30 sec. press. - LED lamp - 3W consumption - Luminous flux 110 lumen (equivalent to 15 W incandescence) - Life 40,000 hours - 1 module (flush-mounted). Cover supplied with device.</p>

Item	Torch and safety LED lamp
○ K4380	 <p>Removable and rechargeable torch with automatic switching on device - it lights up automatically when there is a power cut - push&amp;pull pull-out system complete with recharge base - white light LED with high luminous efficiency - ON/OFF switch and SPOT pushbutton to increase the brightness when necessary - interchangeable Ni-MH batteries without "memory" effect - 2 hour life - low consumption in stand-by 0.4 W - 230 VA power supply - 2 modules</p>
○ 4380NB	 <p>Spare batteries for removable torch</p>
○ K4381	 <p>LED safety lamp with automatic operation when there is a power cut. 230 VA 50/60 Hz - power consumption 2.5 VA (0.1 W) - rechargeable non-replaceable NiMH 3.6 V 140 mAh battery - complete charge in 48 hours - life 2 hours - maximum cable section 1 x 1.5 mm<sup>2</sup> - light intensity 2400 mcd - angle of emission 120° - not pull-out - 1 module</p>

Item	Step marker lamp
○ K4382	 <p>Step marker lamps with white light LEDs - 127/230 V~ - on-off switch - 0.15-0.5 W - 2 modules</p>
○ K4382V12V24	 <p>Step marker lamps as above - 12/24 V~</p>

Item	Cover
<input type="checkbox"/> KW02 <input checked="" type="checkbox"/> KG02 <input type="checkbox"/> KM02  <input checked="" type="checkbox"/> KC02 <input checked="" type="checkbox"/> KS02 <input checked="" type="checkbox"/> KB02	<p><b>1 module</b></p>  <p>Cover for item K4381</p>
<input type="checkbox"/> KW04 <input checked="" type="checkbox"/> KG04 <input type="checkbox"/> KM04  <input checked="" type="checkbox"/> KC04 <input checked="" type="checkbox"/> KS04 <input checked="" type="checkbox"/> KB04	<p><b>2 modules</b></p>  <p>Cover for item K4380</p>
<input type="checkbox"/> KW71 <input checked="" type="checkbox"/> KG71 <input type="checkbox"/> KM71  <input checked="" type="checkbox"/> KC71 <input checked="" type="checkbox"/> KS71 <input checked="" type="checkbox"/> KB71	 <p>Cover for item K4382 and K4382V12V24</p>

# Living Now standard electrical system

## LEDs for backlighting

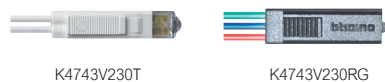

Devices to be completed with appropriate covers as indicated below

Item	LED for control
	LED for backlighting of the following "basic control devices": K4001, K4001A, K4003, K4003A, K4005, K4005A, K4001M2A, K4003M2A, K4005M2A, KW4002, KG4002, KM4002 et K4034
K4743V230T	white LED - 230 VA - high luminosity for daytime load notification
K4743V127T	white LED - 127 VA - high luminosity for daytime load notification
K4743V230R	red LED - 230 VA - high luminosity for daytime load notification
LN4743/230T	white LED - 230 VA - night signal
LN4743/12T	white LED - 12/24 VA - night signal
Y4743V230B	blue LED - 230 VA - night signal
Y4743V12B	blue LED - 12/24 VA - night signal
	Replacement LED for changeover switch (hotel control)
K4743V230RG	Red/green LED - 230 VA for item K4027H
K4743V127RG	Red/green LED - 127 VA for item K4027V127H

### Examples of led connection on a switch

Function: locating

Function: load status LED

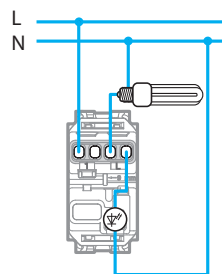
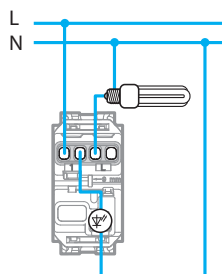

### Control backlighting led connection

**Note:** for the connection of 230 V.a.c. LEDs for the backlighting of control devices: when LEDs are fitted to help locate the control itself, it must be taken into account that energy saving and fluorescent lamps do not allow in series connection of the LED on the load. It is therefore necessary to also take a neutral conductor near the control, so that the LED may be connected directly between phase and neutral, and will always be on.

## blinking modules

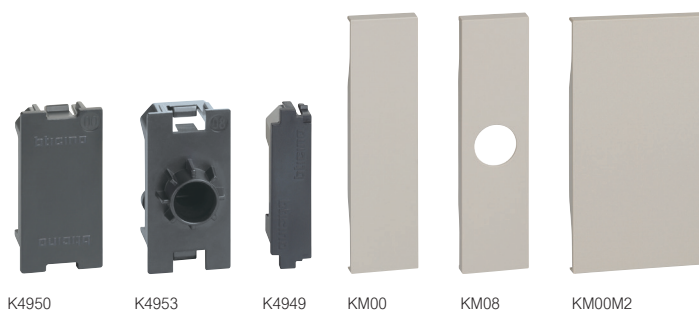

Item	Blanking modules
○ K4950	Blanking module - 1 module
○ K4953	Blanking module with output Ø 9 mm - 1 module
○ K4949	1/2 module blanking module - it does not require the cover
	<b>Cover</b> <b>1 module</b>
□ KW00 ■ KG00 □ KM00	Cover for item K4950
■ KC00 ■ KS00 ■ KB00	
□ KW08 ■ KG08 □ KM08	Cover for item K4953
■ KC08 ■ KS08 ■ KB08	
	<b>2 modules</b>
□ KW00M2 ■ KG00M2 □ KM00M2	Cover for item K4950
■ KC00M2 ■ KS00M2 ■ KB00M2	

# Living Now with Netatmo



## SECTION 2

Living Now with Netatmo

# Smart controls via radio.

The simplest solution to make a traditional system smart.



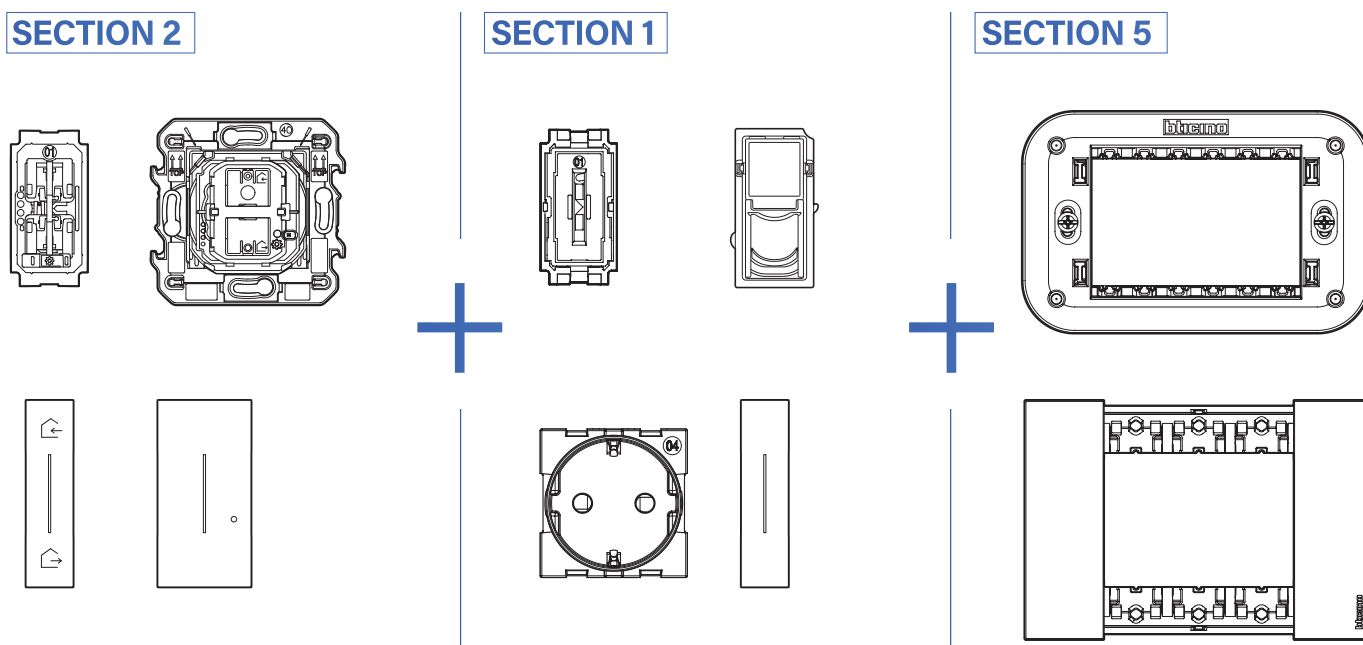









How to choose devices for the composition of the electrical system

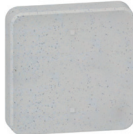

Type of system	Catalog section
Living Now standard system (Switches, sockets, other functions and covers for the residential electrical system)	1 + 5
<b>Living Now with Netatmo</b> <b>(Connected controls for the smart home, which communicate via radio)</b>	<b>2 + 1 + 5</b>
Living Now MyHOME (Advanced Smart Home controls, which communicate via SCS BTicino bus)	3 + 1 + 5
Living Now KNX (Connected controls for the smart home, which communicate via KNX standard bus)	4 + 1 + 5
Living Now electrical system completion (cover plates range, boxes, accessories)	5

Table of choice

Functions	Wired devices (110-230 V~)
 <p>Internet connection</p>	 Gateway K4510CN (*)  Gateway FC80GTN (*)   Home + Control  Home + Pro
 <p>Light</p>	 Connected 1-way switch K4001C  Connected 2 way switch K4003C  Connected dimmer K4011C  Connected dimmer without neutral K4413CM2  Connected lighting micromodule 3584C  DIN smart relay FC80RC
 <p>Shutters and electrical doors</p>	 Changeover switch K4027C  Changeover switch 2 modules K4027CM2N  Connected micromodule ...4027C  Connected module for garage door and gate 3586C
 <p>Scenes</p>	
 <p>Energy management and monitoring</p>	 Connected module for socket K4531C  Connected socket ...4141AC ...4142AC  Connected PLUG & PLAY socket 4141PC  Smart DIN contactor FC80CC  Smart control with dry contact FC80AC  Connected DIN load management module FC80GCS  Smart DIN meter F20T60A - F40T125A (threephase Systems)
 <p>Termo</p>	 Boiler Thermostat ...8002  AC System Thermostat ...8003  IR interface for air conditioning unit 3460IR  Actuator for fan coil unit 0 489 10

Wireless devices (battery powered)	Wireless devices (no-battery)
<div style="display: flex; justify-content: space-around; align-items: flex-start;"> <div style="text-align: center;">  <p>Light control K4003CW K4003CWI (1 module)</p> </div> <div style="text-align: center;">  <p>Double light control ... K4003DCW</p> </div> <div style="text-align: center;">  <p>Wireless motion sensor 3585C</p> </div> <div style="text-align: center;">  <p>Wireless control for multicolor lighting K4007CW K4007CWI (1 module)</p> </div> </div>	<div style="text-align: center;">  <p>IP55 Light switch 28003CWG</p> </div>
<div style="display: flex; justify-content: space-around; align-items: flex-start;"> <div style="text-align: center;">  <p>Shutter control K4027CW</p> </div> <div style="text-align: center;">  <p>Shutter control K4027CWI (1 module)</p> </div> </div>	<div style="text-align: center;">  <p>IP55 Shutters switch 28027CWG</p> </div>
<div style="display: flex; justify-content: space-around; align-items: flex-start;"> <div style="text-align: center;">  <p>Home/Away scenario control K4570CW K4570CWI (1 module)</p> </div> <div style="text-align: center;">  <p>Wake Up / Sleep scenario control K4574CW K4574CWI (1 module)</p> </div> <div style="text-align: center;">  <p>4 scenarios control K4575CW</p> </div> <div style="text-align: center;">  <p>Scenario remote control 3528C</p> </div> </div>	

**For the complete range of products see catalogue pages.**

(\*) Note: for the use of the connected devices, the gateway must be installed as part of the system. If the gateway is connected to the internet through the Wi-Fi network, it will be possible to manage the system from the home using the specific Home + Control App and the vocal commands Google, Alexa and Siri.

And if the internet does not work?  
The devices continue to operate with manual control. The Home+Control app cannot be used.

# Living Now with Netatmo

diagram of a typical smart home system

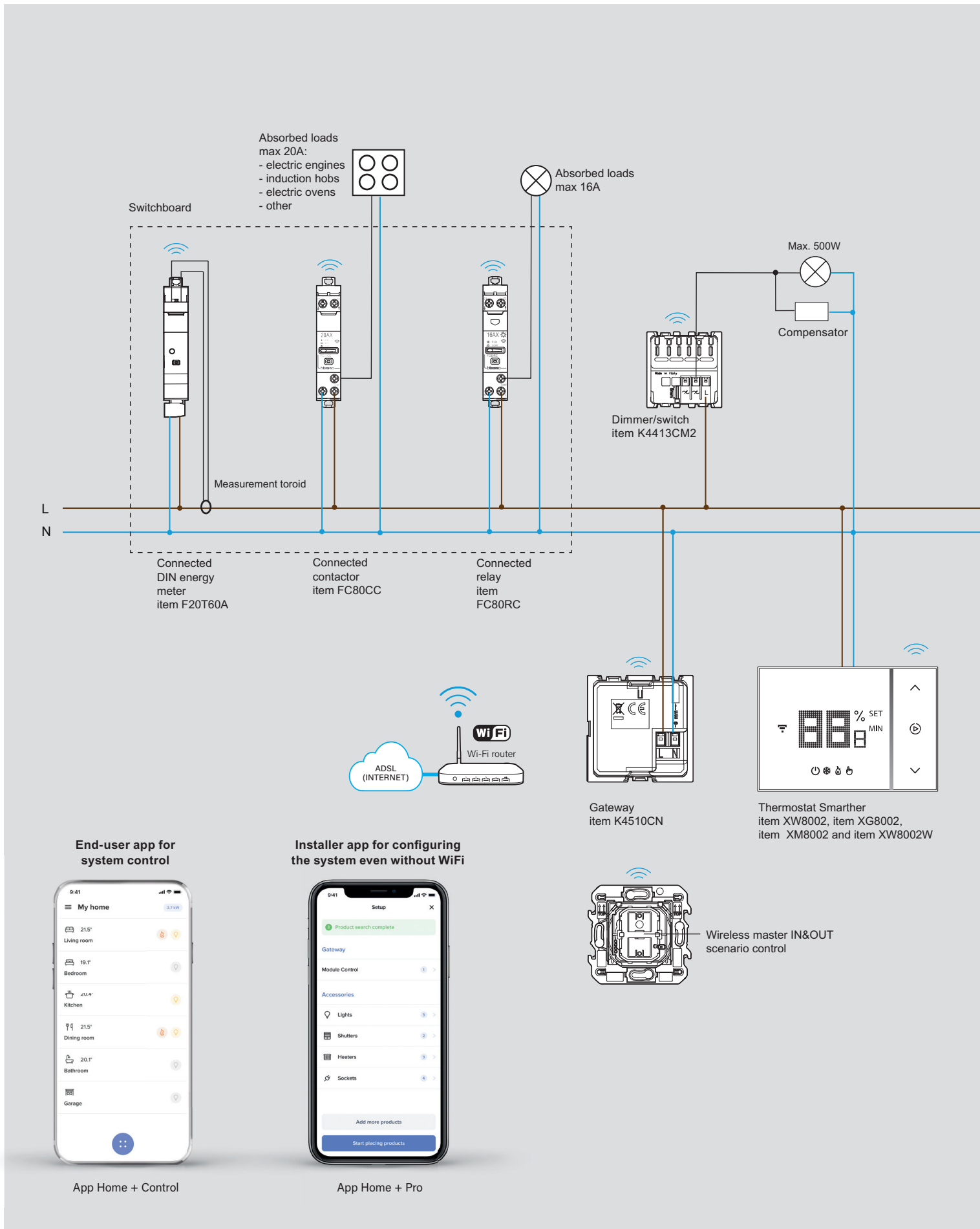

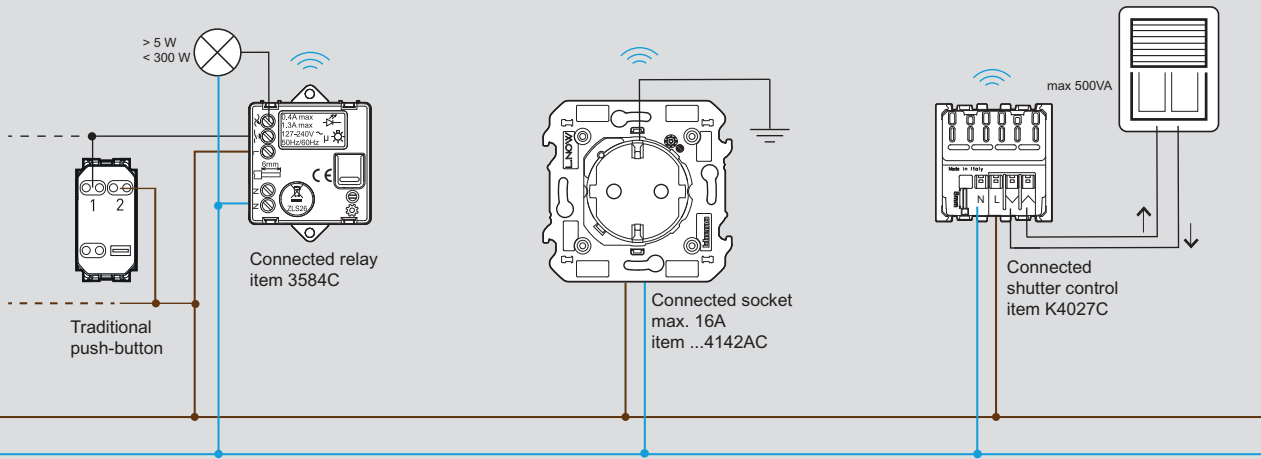

Optional controls for system expansion via radio - wall installation

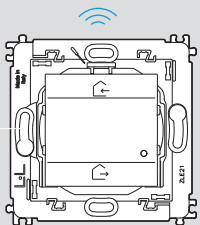

Wireless Home&Away  
scenario control  
item K4570CW

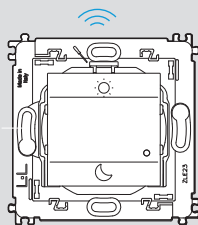

Wireless Wake up &  
Sleep scenario control  
item K4574CW

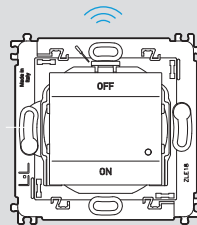

Wireless light control  
item K4003CW

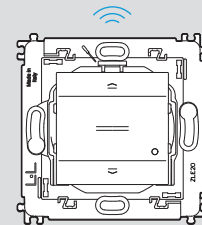

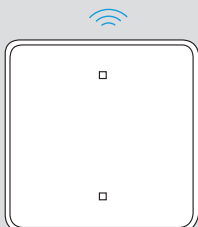

Wireless shutter control  
item K4027CW



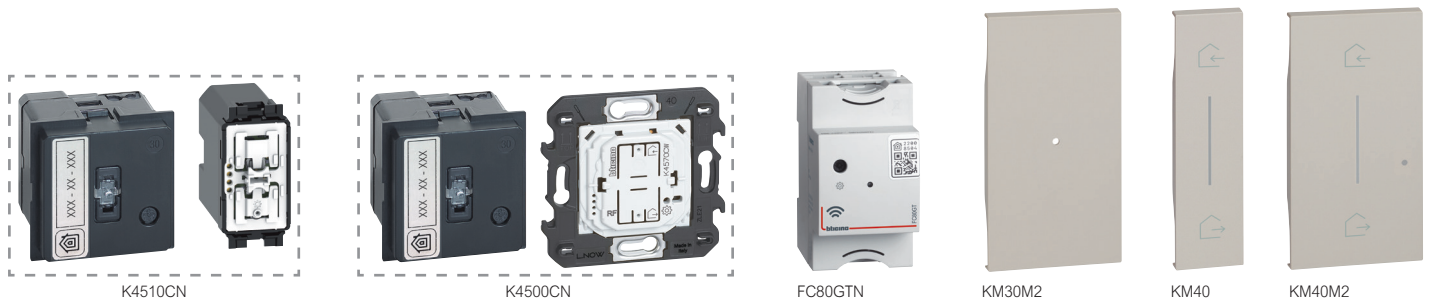

Wireless IP55 light switch  
item 28003CWG

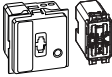
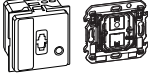

Devices to be completed with appropriate covers as indicated below

Item	Gateway
<input type="radio"/> K4510CN	 <p>Gateway to create a connected installation in the home, supplied with 1 module master IN&amp;OUT scenario control item K4570CW1. It can be used to control lighting, roller shutters and electrical equipment plugged into connected sockets:</p> <ul style="list-style-type: none"> <li>- using your smartphone and the Home + Control App</li> <li>- using voice assistants</li> <li>- from the general control at the entrance to your home</li> </ul> <p>Function configuration via the new free Home + Pro App. Power supply 110-230 VA - 2 modules</p>
<input type="radio"/> K4500CN	 <p>Gateway as above. Supplied with wireless master IN&amp;OUT scenario control item K4570CW. Power supply 110-230 VA - 2 modules</p>
<input type="radio"/> FC80GTN	 <p>Gateway as above for DIN switchboard. Function configuration via the new free Home + Pro app. - 2.5 DIN modules.</p>

Item	Covers required for the gateways
<input type="checkbox"/> KW30M2 <input checked="" type="checkbox"/> KG30M2 <input type="checkbox"/> KM30M2  <input checked="" type="checkbox"/> KC30M2 <input checked="" type="checkbox"/> KS30M2 <input checked="" type="checkbox"/> KB30M2	<p><b>Cover for the gateway</b></p>  <p>Cover for item K4510CN and K4500CN - 2 modules</p>
<input type="checkbox"/> KW40 <input checked="" type="checkbox"/> KG40 <input type="checkbox"/> KM40  <input checked="" type="checkbox"/> KC40 <input checked="" type="checkbox"/> KS40 <input checked="" type="checkbox"/> KB40	<p><b>Covers required for the IN&amp;OUT scenario control</b></p> <p><b>1 module</b></p>  <p>Cover for item K4570CW1</p>
<input type="checkbox"/> KW40M2 <input checked="" type="checkbox"/> KG40M2 <input type="checkbox"/> KM40M2  <input checked="" type="checkbox"/> KC40M2 <input checked="" type="checkbox"/> KS40M2 <input checked="" type="checkbox"/> KB40M2	<p><b>2 modules</b></p>  <p>Cover for item K4570CW</p>

**Voice assistants and apps for managing functions**



**BTicino app for configuring and controlling functions**









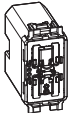

**WARNING:** To use connected devices, you must install a gateway device (item no. K4510CN, K4500CN or item no. FC80GTN) in the system. Both devices allow you to configure the Smart system using the new Home + Pro App, which does not require an internet connection. Systems equipped with gateways (item no. K4500C, item no. K4510C, or item no. FC80GT) that are no longer available are not compatible with the aforementioned app.

# Living Now with Netatmo smart electrical system - MODULAR VERSION

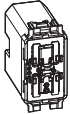
## wired devices for light

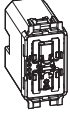



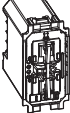

Devices to be completed with appropriate covers as indicated below

Item	Connected devices for light	Item	Connected devices for light
○ K4001C	 <p>Connected one-way switch. It controls the lights locally or remotely. It can be installed like a traditional two-way switch and is compatible with all loads with max. power 250 W. It has a blue LED, which can be configured using the Home + Control App for the localisation and load status functions. It can be associated to one or more wireless controls. Caution: neutral connection is necessary. Power supply 110-230 V~ - 1 module</p>	○ 4411C	 <p>Connected relay/dimmer with neutral. To be used in ceiling or flush-mounted boxes to be connected to the lights to be managed. It can be connected to one or more traditional buttons or associated with one or more wireless controls. It natively performs the function of ON/OFF switch but can be configured via the Home+Control App to also function as a Dimmer, local or remote. Compatible with all loads: dimmable LED and CFL lamps 150 W LED, incandescent and halogen lamps 150 W, ELV halogen lamps and CFL with separate ballast 150 VA. Power supply 110-230 Va.c.</p>
○ K4006C	 <p>Connected one-way switch without neutral. It controls the lights locally or remotely. It can be installed like a traditional two-way switch and is compatible with all loads with max. power 200 W. It has a blue LED, which can be configured using the Home + Control App for the localisation and load status functions. It can be associated to one or more wireless controls. Caution: neutral connection is NOT necessary. Power supply 110-230 VA - 1 module</p>	<p><b>Cover</b></p> <p><b>1 module</b></p> <ul style="list-style-type: none"> <li><input type="checkbox"/> KW01</li> <li><input type="checkbox"/> KG01</li> <li><input type="checkbox"/> KM01</li> </ul>  <p>Cover for item K4001C, K4003C, K4006C and K4411C</p>	
○ K4003C	 <p>Connected 2ways switch. It allows to control lights locally or remotely. The connected 2ways switch has the same installation and usability of a traditional 2ways switch and it is compatible with all loads with max pover 250 W. It s equipped with a blue LED light used always on for localization modality or on, when the light is on for the load status modality. It can be associated with "wireless light switches". Caution: Must be connected to the neutral. Power supply 110-230 V~ - 1 module</p>		
○ 3584C	 <p>Connected lighting micromodule. It allows to control lights locally or remotely. It is compatible with all loads with max pover 300 W. It can be connected to one or more traditional push-button or associated with "wireless light switches". It is installed as a traditional rele in the box (behind the button) or in derivation boxes. Caution: Must be connected to the neutral. Power supply 110-230 V~</p>	<ul style="list-style-type: none"> <li><input type="checkbox"/> KW01M2</li> <li><input type="checkbox"/> KG01M2</li> <li><input type="checkbox"/> KM01M2</li> </ul> <p><b>2 modules</b></p>  <p>Cover for item K4001C, K4003C, K4006C and K4411C</p>	
○ FC80RC	 <p>DIN switchboard light device for loads with absorption In= 16 A. Equipped with a meter measuring the current absorbed by the load and contacts for control with up to 10 pushbuttons. 1 DIN module. Power supply 110-230 V~</p>		
○ K4411C	 <p>Dimmer/switch. It allows to control lights locally or remotely, with the dimmer functionality that can be activated from APP Home+Control. It has the same installation and usability of a traditional switch and it is compatible with all loads (LED, halogen) with max power 150 W at 230 V (or 75 W at 110 V). It s equipped with a blue LED light used for localization modality or load status modality, configurable by APP. It can be connected to one or more traditional push-button or associated with "wireless light switches". Caution: Must be connected to the neutral. Power supply 110-230 V~ - 1 module</p>	<ul style="list-style-type: none"> <li><input type="checkbox"/> KW01M2</li> <li><input type="checkbox"/> KG01M2</li> <li><input type="checkbox"/> KM01M2</li> </ul>	

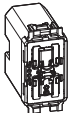

Devices to be completed with appropriate covers as indicated below

Item	Connected devices for shutters
○ K4027C	 <p>Connected rolling shutter switch - It allows the control of a shutter locally or remotely. Compatible with all standard rolling shutter motors ( with a mechanical or electromechanical stop and max power 500 VA ) controlled by a wired shutter switch (switching of the same motor power supply). Not compatible with motors for radio-controlled or pulse-controlled roller shutters. It can be associated with one or more wireless commands. Caution: Must be connected to the neutral. Power supply 110-230 V~ - 1 module</p>
○ 4027C	 <p>Connected micromodule for shutters. Associated to one or more shutter wireless controls, it controls a shutter locally or remotely. Compatible with all standard shutter motors (with mechanical or electronic limit switch and maximum power 500 VA), controlled by a wired shutter changeover switch (changeover with the same power supply as the motor). Not compatible with radio controlled or pulse controlled shutter motors. It can be installed in the existing shutter box with no need of masonry works. Power supply 110-230 V~</p>

Item	Cover
<input type="checkbox"/> KW32 <input checked="" type="checkbox"/> KG32 <input type="checkbox"/> KM32  <input checked="" type="checkbox"/> KC32 <input checked="" type="checkbox"/> KS32 <input checked="" type="checkbox"/> KB32	<b>1 module</b>  Cover for item K4027C
<input type="checkbox"/> KW32M2 <input checked="" type="checkbox"/> KG32M2 <input type="checkbox"/> KM32M2  <input checked="" type="checkbox"/> KC32M2 <input checked="" type="checkbox"/> KS32M2 <input checked="" type="checkbox"/> KB32M2	<b>2 modules</b>  Cover for item K4027C







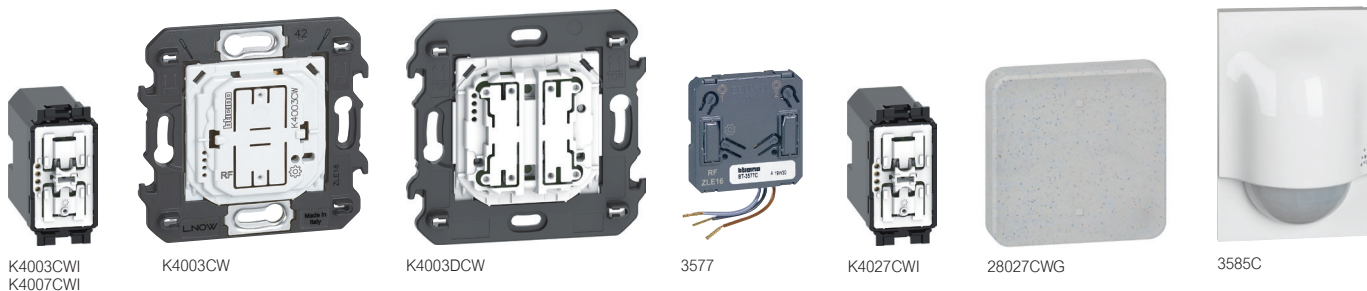

Item	Connected module for garage, door and gate
○ 3586C	 <p>Enables open/close control of a garage door or gate, locally, remotely or via voice assistant. Status display (open/closed/half open) in the Home + Control App. Can be steered using a wireless shutter control or can be controlled from the remote control art.3528C. Supplied with 2 wired position sensors and specific fixtures. Can be installed into an IP55 box 80 x 80 mm or larger. Fitted with 2 separable fixing points. CAUTION: to operate optimally, the gate engine must be setup in step-by-step mode. In this mode the engine workd with the following cycle: OPEN-STOP-CLOSE-STOP-OPEN-</p>

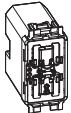
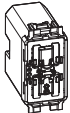
# Living Now with Netatmo smart electrical system - MODULAR VERSION

## wireless controls for light and shutter



Devices to be completed with appropriate covers as indicated below

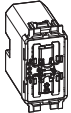







Item	Wireless controls for light	Item	Wireless controls for shutter
○ K4003CWI ○ K4007CWI	 Wireless light switch. It allows the ON / OFF and dimming control of one or more connected devices for the lighting control. It can be installed in any flush-mounted box without any wiring. The battery can be replaced without removing it from the supporting frame. Integrated LED for low battery indication. Powered by battery 3V type CR2032 (supplied) with an autonomy of 8 years - 1 module	○ K4027CWI	 Rolling shutter wireless switch - It allows the control of one or more connected rolling shutter switches. It can be installed in any flush-mounted box without any wiring. The battery can be replaced without removing it from the supporting frame. Integrated LED for low battery indication. Powered by battery 3V type CR2032 (supplied) with an autonomy of 8 years - 1 module
○ K4003CW	 Wireless light switch. It allows the ON / OFF and dimming control of one or more connected devices for the lighting control. Surface installation with repositionable stickers (supplied) or onto a flush mounting box. Integrated LED for low battery indication. Powered by battery 3V type CR2032 (supplied) with an autonomy of 8 years - 2 modules	○ K4027CW	 Rolling shutter wireless switch - It allows the control of one or more connected rolling shutter switches. Surface installation with repositionable stickers (supplied) or onto a flush mounting box. Integrated LED for low battery indication. Powered by battery 3V type CR2032 (supplied) with an autonomy of 8 years - 2 modules
○ K4003DCW	 Wireless light switch. It is equipped with two buttons to control two different connected devices for lights. Each single button can be associated with one or more devices. Surface installation with repositionable stickers (supplied) or onto a flush mounting box. Integrated LED for low battery indication. Powered by battery 3V type CR2032 (supplied) with an autonomy of 8 years - 2 modules	○ 3585C	 <b>Motion sensor wireless</b> It controls one or more devices connected for light control. Infrared detection with angle of 140°. Distance of the adjustable sensor from 2 to 8 m. Switch off delay with 1 to 30 min adjustable delay time and 1 to 1000 lux brightness threshold. Test possible with a 5 sec. delay Recommended assembly height: 2.5 m. Optimum distance between 2 detectors: 6 m. For indoor and outdoor use (IP44). Supplied with 2 1.5V AA batteries for power supply.
○ 3577C	 It allows to change a traditional two-way switch or a pushbutton into a wireless control for one connected device for light control (ON/OFF). The small size allows the installation in the flush mounted box. CR2032 type 3V power battery with 8 year expected life supplied (as standard).	○ 28003CWG	 <b>No-Battery wireless controls</b> Wireless IP55 light switch No-Battery
○ K4007CW	 Wireless switch for multicolour lighting. Allow to directly control up to 20 Zigbee 3.0 compatible multi-colour lighting (e.g. Ledvance Smart+ Zigbee, Philips Hue...). To be associated with the lighting in the Home + Control App. Allow ON/OFF and dimming control of 3 light moods which have to be preset in the Home +Control App. Surface installation with repositionable stickers (supplied) or onto a flush mounting box. Integrated LED for low battery indication. Powered by 3V battery type CR2032 (supplied) with an autonomy of 8 years - 2 modules.	○ 28027CWG	 Wireless IP55 shutter switch. No-Battery
○ K4007CWI	 Wireless switch for multicolour lighting. Allow to directly control up to 20 Zigbee 3.0 compatible multi-colour lighting (e.g. Ledvance Smart+ Zigbee, Philips Hue...). To be associated with the lighting in the Home + Control App. Allow ON/OFF and dimming control of 3 light moods which have to be preset in the Home +Control App. Supplied with CR2032 3 V long-life battery for power supply. LED function for low battery - 1 module		

# Living Now with Netatmo smart electrical system - MODULAR VERSION

wireless controls for light and shutter



Devices to be completed with appropriate covers as indicated below







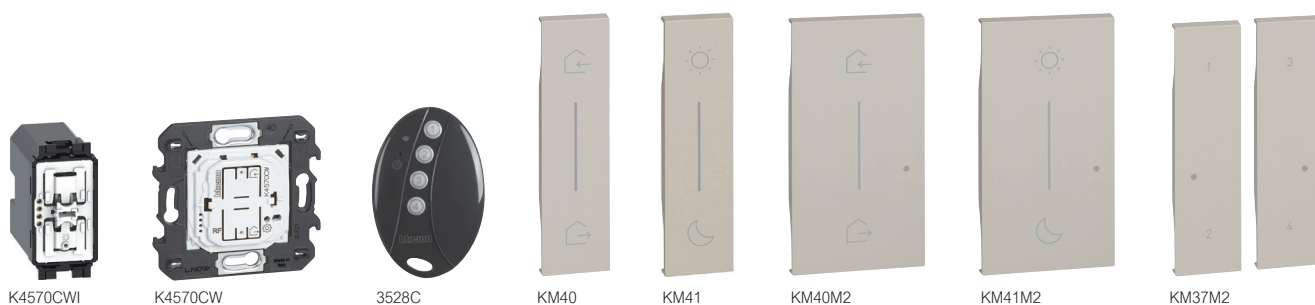

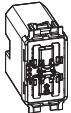

Item	Cover	Item	Cover
<input type="checkbox"/> KW01 <input checked="" type="checkbox"/> KG01 <input type="checkbox"/> KM01  <input checked="" type="checkbox"/> KC01 <input checked="" type="checkbox"/> KS01 <input checked="" type="checkbox"/> KB01	<b>1 module</b>  Cover for item K4003CWI	<input type="checkbox"/> KW01M2 <input checked="" type="checkbox"/> KG01M2 <input type="checkbox"/> KM01M2  <input checked="" type="checkbox"/> KC01M2 <input checked="" type="checkbox"/> KS01M2 <input checked="" type="checkbox"/> KB01M2	<b>2 modules</b>  Cover for item K4003CWI
<input type="checkbox"/> KW32 <input checked="" type="checkbox"/> KG32 <input type="checkbox"/> KM32  <input type="checkbox"/> KC32 <input checked="" type="checkbox"/> KS32 <input type="checkbox"/> KB32	 Cover for item K4027CWI	<input type="checkbox"/> KW32M2 <input checked="" type="checkbox"/> KG32M2 <input type="checkbox"/> KM32M2  <input checked="" type="checkbox"/> KC32M2 <input checked="" type="checkbox"/> KS32M2 <input checked="" type="checkbox"/> KB32M2	 Cover for item K4027CWI
<input type="checkbox"/> KW39 <input checked="" type="checkbox"/> KG39 <input type="checkbox"/> KM39  <input checked="" type="checkbox"/> KC39 <input checked="" type="checkbox"/> KS39 <input checked="" type="checkbox"/> KB39	 Cover for item K4007CWI	<input type="checkbox"/> KW42M2 <input checked="" type="checkbox"/> KG42M2 <input type="checkbox"/> KM42M2  <input checked="" type="checkbox"/> KC42M2 <input checked="" type="checkbox"/> KS42M2 <input checked="" type="checkbox"/> KB42M2	 Cover for item K4003CW
		<input type="checkbox"/> KW36M2 <input checked="" type="checkbox"/> KG36M2 <input type="checkbox"/> KM36M2  <input checked="" type="checkbox"/> KC36M2 <input checked="" type="checkbox"/> KS36M2 <input checked="" type="checkbox"/> KB36M2	 Cover for item K4003DCW
		<input type="checkbox"/> KW43M2 <input checked="" type="checkbox"/> KG43M2 <input type="checkbox"/> KM43M2  <input type="checkbox"/> KW43M2 <input checked="" type="checkbox"/> KG43M2 <input type="checkbox"/> KM43M2	 Cover for item K4027CW
		<input type="checkbox"/> KW39M2 <input checked="" type="checkbox"/> KG39M2 <input type="checkbox"/> KM39M2  <input checked="" type="checkbox"/> KC39M2 <input checked="" type="checkbox"/> KS39M2 <input checked="" type="checkbox"/> KB39M2	 Cover for item K4007CW

# Living Now with Netatmo smart electrical system - MODULAR VERSION

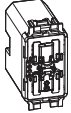
## wireless controls for scenarios management



Devices to be completed with appropriate covers as indicated below





Item	Wireless Home/Away scenario controls	Item	Cover
○ K4570CWI	 <p>Home / Away wireless switch. It is equipped with 2 buttons for activating Home / Away scenarios. Scenarios can be customized by the Home + Control app. It can be installed in any flush-mounted box without any wiring. The battery can be replaced without removing it from the supporting frame. Integrated LED for low battery indication. Powered by battery 3V type CR2032 (supplied) with an autonomy of 8 years - 1 module</p>	<input type="checkbox"/> KW40 <input checked="" type="checkbox"/> KG40 <input type="checkbox"/> KM40  <input checked="" type="checkbox"/> KC40 <input checked="" type="checkbox"/> KS40 <input checked="" type="checkbox"/> KB40	<b>1 module</b>  Cover for item K4570CWI
○ K4570CW	 <p>Home / Away wireless switch. It is equipped with 2 buttons for activating Home / Away scenarios. Scenarios can be customized by the Home + Control app. Surface installation with repositionable stickers (supplied) or onto a flush mounting box. Integrated LED for low battery indication. Powered by battery 3V type CR2032 (supplied) with an autonomy of 8 years - 2 modules</p>	<input type="checkbox"/> KW41 <input checked="" type="checkbox"/> KG41 <input type="checkbox"/> KM41  <input checked="" type="checkbox"/> KC41 <input checked="" type="checkbox"/> KS41 <input checked="" type="checkbox"/> KB41	 Cover for item K4570CW
○ K4574CWI	 <p>It is equipped with 2 buttons for activating Wake Up / Sleep scenarios. Scenarios can be customized by the Home + Control app. It can be installed in any flush-mounted box without any wiring. The battery can be replaced without removing it from the supporting frame. Integrated LED for low battery indication. Powered by battery 3V type CR2032 (supplied) with an autonomy of 8 years - 1 module</p>	<input type="checkbox"/> KW40M2 <input checked="" type="checkbox"/> KG40M2 <input type="checkbox"/> KM40M2  <input checked="" type="checkbox"/> KC40M2 <input checked="" type="checkbox"/> KS40M2 <input checked="" type="checkbox"/> KB40M2	<b>2 modules</b>  Cover for item K4570CW
○ K4574CW	 <p>It is equipped with 2 buttons for activating Wake Up / Sleep scenarios. Scenarios can be customized by the Home + Control app. Surface installation with repositionable stickers (supplied) or onto a flush mounting box. Integrated LED for low battery indication. Powered by battery 3V type CR2032 (supplied) with an autonomy of 8 years - 2 modules</p>	<input type="checkbox"/> KW41M2 <input checked="" type="checkbox"/> KG41M2 <input type="checkbox"/> KM41M2  <input checked="" type="checkbox"/> KC41M2 <input checked="" type="checkbox"/> KS41M2 <input checked="" type="checkbox"/> KB41M2	 Cover for item K4574CW
○ K4575CW	 <p><b>Wireless 4 scenarios control</b>            It's equipped with 4 buttons for activating of scenarios 1,2,3 and 4. Scenarios can be customized by the Home+ Control app. Surface installation with repositionable stickers (supplied) or onto a flushmounting box. Integrated LED for low battery indication. Powered by battery 3V type CR2032 (supplied) with an autonomy of 8 years - 2 modules.</p>	<input type="checkbox"/> KW37M2 <input checked="" type="checkbox"/> KG37M2 <input type="checkbox"/> KM37M2  <input checked="" type="checkbox"/> KW37M2 <input checked="" type="checkbox"/> KG37M2 <input checked="" type="checkbox"/> KM37M2	 Cover for item K4575CW
○ 3528C	 <p><b>Pocket remote control 4 scenarios</b>            It allows to add a wireless remote control in your system. Is equipped with 4 keys for the activation of the 1,2,3 and 4 scenarios. The scenarios can be activated and customized by the Home + Control app. Integrated LED for low battery indication. Powered by battery 3V type CR2032 (supplied) with an autonomy of 8 years.</p>		

# Living Now with Netatmo smart electrical system - MODULAR VERSION

connected sensors for temperature management and home protection



Devices to be completed with appropriate covers as indicated below

Item	Internal temperature and humidity sensor	Item	Cover
<input type="radio"/> K4587C  Wireless indoor temperature and humidity sensor. Measures the temperature and humidity of the environment where it is installed and displays the data via the Home+Control app. Surface-mounted installation using repositionable adhesive strips (included) or on flush-mounted boxes. Powered by a 3V CR2032 battery (included). Size: 2 modules.	<input type="checkbox"/> KW45M2 <input checked="" type="checkbox"/> KG45M2 <input type="checkbox"/> KM45M2  <input checked="" type="checkbox"/> KC45M2 <input checked="" type="checkbox"/> KS45M2 <input checked="" type="checkbox"/> KB45M2	<input type="checkbox"/> KW45M2 <input checked="" type="checkbox"/> KG45M2 <input type="checkbox"/> KM45M2  <input checked="" type="checkbox"/> KC45M2 <input checked="" type="checkbox"/> KS45M2 <input checked="" type="checkbox"/> KB45M2	1 module  Cover for temperature and humidity sensor item K4587C.
<input checked="" type="checkbox"/> 3588GC  <input type="checkbox"/> 3588SC <input type="checkbox"/> 3588WC	<b>External temperature and brightness sensor</b>  Wireless outdoor temperature and light sensor. Measures outdoor temperature and light intensity, viewable via Home+Control app. Powered by 3.2V AAA battery (included), rechargeable through integrated solar panel. Surface wall installation with screw mounting. Black finish. As above, sand As above, white		
<input type="radio"/> 3590C	<b>Water leak sensor</b>  Wireless water leak sensor. Detects leaks and notifies the user via Home+Control app. Equipped with buzzer for acoustic feedback. Surface installation using supplied adhesive. Powered by 3V CR2032 battery (included).		
<input type="checkbox"/> 3591WC  <input checked="" type="checkbox"/> 3591BC	<b>Wireless door and window opening sensor.</b>  Wireless door and window opening sensor. Detects open/closed status and sends feedback to the system, which can use it to manage scenarios and actions set by the user via Home+Control app. Powered by 3V CR2032 battery (included). Surface installation using supplied adhesive strips or screw mounting. White finish. As above, black		

# Living Now with Netatmo smart electrical system - MODULAR VERSION

controls for energy management and gateway

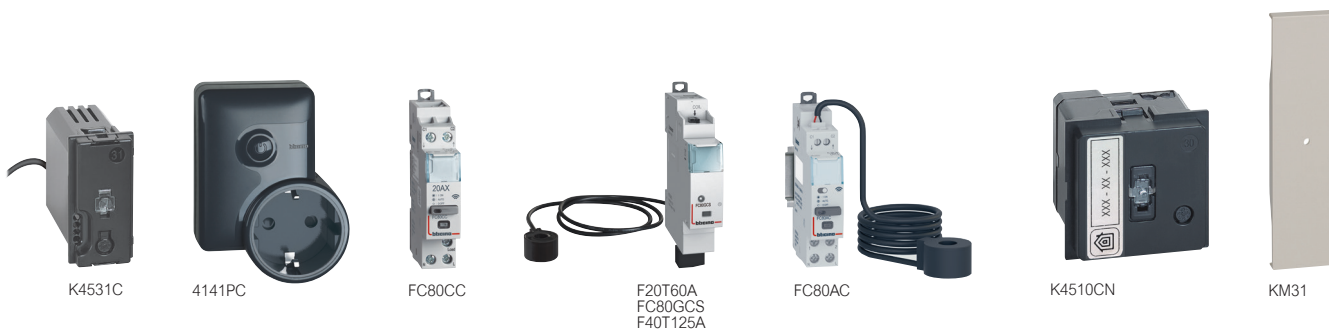

Devices to be completed with appropriate covers as indicated below

Item	Connected module for energy management
○ K4531C	Connected socket module - wiring to a power outlet, allows to remotely control appliances and check the consumption ( instantaneous, daily, monthly ). It is also possible to receive notifications in case of anomalous consumption. The connected socket module is compatible with any device electric and large appliances up to 16 A 3680 W max. (protected against overloads). It is equipped with a LED light lit in blue when it is on. This option can be enabled or disabled in the "Home+Control" app. It can be associated with "wireless light switches". Power supply 110-230 V~ - 1 module
○ 4141PC	Mobile connected German standard power outlet -plug&play-. Directly connected to an existing socket, it allows remote control of all the connected electrical appliances. It also monitors the instantaneous, daily and monthly consumption. Compatible with all the devices with power up to 16 A 3680 W (with overload protection). It can be associated to wireless light controls. Power supply 110-230 V~
○ 4142PC	As above French/belgian standard socket.
○ FC80CC	Connected contactor for single-phase and/or three-phase loads with maximum absorption In= 20 A. With meter for the measurement of the current absorbed by the load. Power supply 110-230 V~ - 1 DIN module
○ F20T60A	Connected DIN meter. It allows to measure the energy consumption of the house electric installation (instantaneous, daily, monthly). It is also possible to receive notifications in case of exceeded the maximum power provided by your contract to avoid possible black-out. A toroid is provided to read the current. Power supply 110-230 V~ - 1 DIN module
○ F40T125A	As above. Three-phase module

Item	Connected module for energy management
○ FC80GCS	Connected DIN load management module for the monitoring of the consumptions of the whole electric system, the powering or disconnection of the loads, and the setting of scenarios with priority or non-priority loads. When the maximum intended power is reached, the non-priority loads are temporarily disconnected to avoid black-outs. A toroid for the current reading is provided. Power supply 110-230 V~ - 1 DIN module
○ FC80AC	Smart device for controlling and measuring the consumption of equipment fitted with dry contacts. Rating 12V/30Vdc or 230Vac 2A max. Ideal for controlling and measuring heating appliances, wallboxes and electric vehicle charging stations, ventilation systems, irrigation systems and any other device with a control dry contact. Not suitable for shutter automation. A toroid is supplied, for the measurement of the current absorbed by the load, max 80A. Function management through the Home + Control App, compatible with load management module FC80GCS. 1 DIN module. 100-240V a.c. power supply 50/60 Hz. Requires a Zigbee gateway.

Item	Cover for item K4531C
○ KW31	<b>1 module</b> Cover for item K4531C
■ KG31	
■ KM31	
■ KC31	
■ KS31	
■ KB31	

○ Neutral item (K) (without cover)



K4510CN

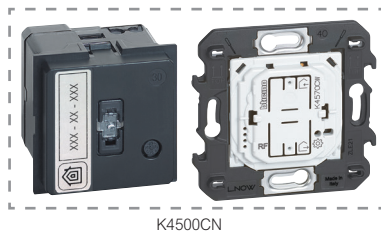

K4500CN



FC80GTN



KM30M2







KM40

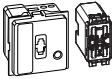
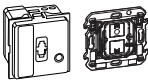

KM40M2

Devices to be completed with appropriate covers as indicated below

Item	Gateway
<input type="radio"/> K4510CN	 <p>Gateway to create a connected installation in the home, supplied with 1 module master IN&amp;OUT scenario control item K4570CW1. It can be used to control lighting, roller shutters and electrical equipment plugged into connected sockets:</p> <ul style="list-style-type: none"> <li>- using your smartphone and the Home + Control App</li> <li>- using voice assistants</li> <li>- from the general control at the entrance to your home</li> </ul> <p>Function configuration via the new free Home + Pro App. Power supply 110-230 VA - 2 modules</p>
<input type="radio"/> K4500CN	 <p>Gateway as above. Supplied with wireless master IN&amp;OUT scenario control item K4570CW. Power supply 110-230 VA - 2 modules</p>
<input type="radio"/> FC80GTN	 <p>Gateway as above for DIN switchboard. Function configuration via the new free Home + Pro app. - 2.5 DIN modules.</p>

Item	Covers required for the gateways
<input type="checkbox"/> KW30M2 <input checked="" type="checkbox"/> KG30M2 <input type="checkbox"/> KM30M2  <input checked="" type="checkbox"/> KC30M2 <input checked="" type="checkbox"/> KS30M2 <input checked="" type="checkbox"/> KB30M2	<p><b>Cover for the gateway</b></p>  <p>Cover for item K4510CN and K4500CN - 2 modules</p>
<input type="checkbox"/> KW40 <input checked="" type="checkbox"/> KG40 <input type="checkbox"/> KM40  <input checked="" type="checkbox"/> KC40 <input checked="" type="checkbox"/> KS40 <input checked="" type="checkbox"/> KB40	<p><b>Covers required for the IN&amp;OUT scenario control</b></p> <p><b>1 module</b></p>  <p>Cover for item K4570CW1</p>
<input type="checkbox"/> KW40M2 <input checked="" type="checkbox"/> KG40M2 <input type="checkbox"/> KM40M2  <input checked="" type="checkbox"/> KC40M2 <input checked="" type="checkbox"/> KS40M2 <input checked="" type="checkbox"/> KB40M2	<p><b>2 modules</b></p>  <p>Cover for item K4570CW</p>

**Voice assistants and apps for managing functions**



**BTicino app for configuring and controlling functions**









**WARNING:** To use connected devices, you must install a gateway device (item no. K4510CN, K4500CN or item no. FC80GTN) in the system. Both devices allow you to configure the Smart system using the new Home + Pro App, which does not require an internet connection. Systems equipped with gateways (item no. K4500C, item no. K4510C, or item no. FC80GT) that are no longer available are not compatible with the aforementioned app.

# Living Now with Netatmo smart electrical system - EUROPEAN VERSION

## wired devices for light







Devices to be completed with appropriate covers as indicated below

Item	Connected devices for light	Item	Cover
○ 3584C	 <p>Connected lighting micromodule. It allows to control lights locally or remotely. It is compatible with all loads with max power 300 W. It can be connected to one or more traditional push-button or associated with "wireless light switches". It is installed as a traditional rele in the box (behind the button) or in derivation boxes. Caution: Must be connected to the neutral. Power supply 110-230 V~</p>	<input type="checkbox"/> KW33M2 <input checked="" type="checkbox"/> KG33M2 <input type="checkbox"/> KM33M2  <input checked="" type="checkbox"/> KC33M2 <input checked="" type="checkbox"/> KS33M2 <input checked="" type="checkbox"/> KB33M2	<b>2 modules</b>  Cover for item K4413CM2
○ FC80RC	 <p>DIN switchboard light device for loads with absorption <math>I_n = 16</math> A. Equipped with a meter measuring the current absorbed by the load and contacts for control with up to 10 pushbuttons. Power supply 110-230 V~ - 1 DIN module</p>	<input type="checkbox"/> KW01M2 <input checked="" type="checkbox"/> KG01M2 <input type="checkbox"/> KM01M2	 Cover for item K4412CM2
○ K4413CM2	 <p>Switch without neutral, 125 W LED, with dimmer option, wired, 2 modules. For local or remote ON/OFF or dimming control of lighting. Can be controlled by one or several wireless light switches and/or mechanical push-buttons. Dimmer mode and locator and indicator functions can be activated from the Home + Control App. Compatible with all loads:            - Dimmable LEDs and CFL lamps: 125 W LED            - Incandescent and halogen lamps: 125 W            - ELV halogen and CFL lamps with separate ballast: 125 VA            Supplied with a bleeder. Memory level function.            - 2 modules</p>	<input checked="" type="checkbox"/> KC01M2 <input checked="" type="checkbox"/> KS01M2 <input checked="" type="checkbox"/> KB01M2	
○ 4411C	 <p>Connected relay/dimmer with neutral. To be used in ceiling or flush-mounted boxes to be connected to the lights to be managed. It can be connected to one or more traditional buttons or associated with one or more wireless controls. It natively performs the function of ON/OFF switch but can be configured via the Home+Control App to also function as a Dimmer, local or remote. Compatible with all loads: dimmable LED and CFL lamps 150 W LED, incandescent and halogen lamps 150 W, ELV halogen lamps and CFL with separate ballast 150 VA. Power supply 110-230 Va.c.</p>		
○ K4412CM2	 <p>Dimmer/switch including: - n° 1 item K4411C            1 module Dimmer/Switch - n° 2 items K4949 half-module blanking modules. Note: it is necessary to install the two "halfmodule blanking modules" (item K4949) at the sides of the dimmer/switch. Features of dimmer/switch item K4411C: it allows to control lights locally or remotely, with the dimmer functionality that can be activated from APP Home+Control. It has the same installation and usability of a traditional switch and it is compatible with all loads (LED, halogen) with max power 150 W at 230 V (or 75 W at 110 V). It's equipped with a blue LED light used for localization modality or load status modality, configurable by APP. It can be connected to one or more traditional push-button or associated with "wireless light switches". Caution: Must be connected to the neutral. Power supply 110-230 Va.c.            - 2 modules.</p>		



Devices to be completed with appropriate covers as indicated below



Item	Connected devices for shutters	Item	Cover
○ K4027CM2N	 <p>Connected shutter control for the local or remote control of a shutter. Compatible with all standard shutter motors (with mechanical or electronic limit switch and maximum power 500 VA), controlled by a wired shutter changeover switch (changeover with the same power supply as the motor). Not compatible with radio controlled or pulse controlled shutter motors. It can be associated to one or more wireless controls. Power supply 110-230 V~ - 2 modules</p>	<input type="checkbox"/> KW32M2 <input checked="" type="checkbox"/> KG32M2 <input type="checkbox"/> KM32M2  <input checked="" type="checkbox"/> KC32M2 <input checked="" type="checkbox"/> KS32M2 <input checked="" type="checkbox"/> KB32M2	<b>1 module</b>  <p>Cover for item K4027CM2N</p>
○ 4027C	 <p>Connected micromodule for shutters. Associated to one or more shutter wireless controls, it controls a shutter locally or remotely. Compatible with all standard shutter motors (with mechanical or electronic limit switch and maximum power 500 VA), controlled by a wired shutter changeover switch (changeover with the same power supply as the motor). Not compatible with radio controlled or pulse controlled shutter motors. It can be installed in the existing shutter box with no need of masonry works. Power supply 110-230 V~</p>		
○ 3586C	 <p>Enables open/close control of a garage door or gate, locally, remotely or via voice assistant. Status display (open/closed/half open) in the Home + Control App. Can be steered using a wireless shutter control or can be controlled from the remote control art.3528C. Supplied with 2 wired position sensors and specific fixtures. Can be installed into an IP55 box 80 x 80 mm or larger. Fitted with 2 separable fixing points. <b>CAUTION:</b> to operate optimally, the gate engine must be setup in step-by-step mode. In this mode the engine workd with the following cycle: OPEN-STOP-CLOSE-STOP-OPEN-</p>		

# Living Now with Netatmo smart electrical system - EUROPEAN VERSION

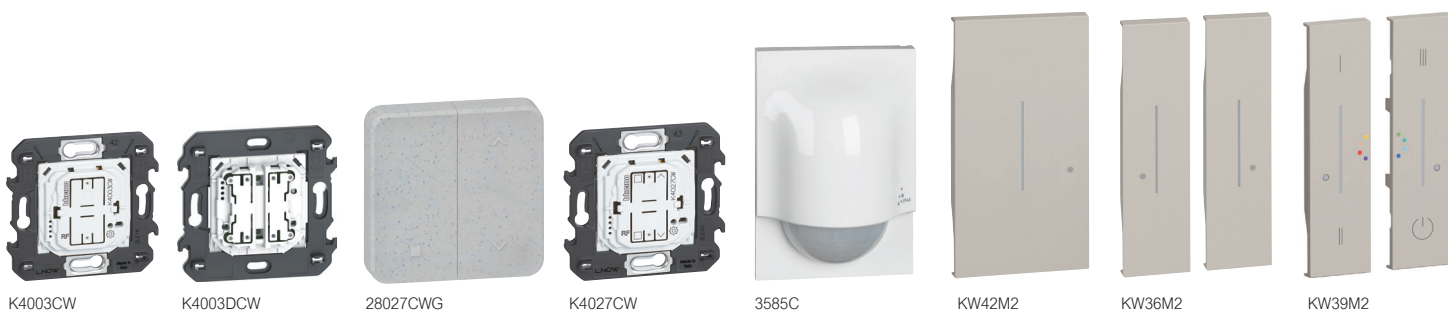

## wireless controls for light and shutter







Devices to be completed with appropriate covers as indicated below

Item	Wireless controls for light
○ K4003CW	 <p>Wireless light switch. It allows the control of one or more connected devices for the lighting control. Surface installation with repositionable stickers (supplied) or onto a flush mounting box. Integrated LED for low battery indication. Powered by battery 3V type CR2032 (supplied) with an autonomy of 8 years - 2 modules</p>
○ K4003DCW	 <p>Wireless light switch. It is equipped with two buttons to control two different connected devices for lights. Each single button can be associated with one or more devices. Surface installation with repositionable stickers (supplied) or onto a flush mounting box. Integrated LED for low battery indication. Powered by battery 3V type CR2032 (supplied) with an autonomy of 8 years - 2 modules</p>
○ K4007CW	 <p>Wireless switch for multicolour lighting. Allow to directly control up to 20 Zigbee 3.0 compatible multi-colour lighting (e.g. Ledvance Smart+ Zigbee, Philips Hue...). To be associated with the lighting in the Home + Control App. Allow ON/OFF and dimming control of 3 light moods which have to be preset in the Home +Control App. Surface installation with repositionable stickers (supplied) or onto a flush mounting box. Integrated LED for low battery indication. Powered by 3V battery type CR2032 (supplied) with an autonomy of 8 years - 2 modules.</p>







Item	Wireless controls for shutter
○ K4027CW	 <p>Rolling shutter wireless switch - It allows the control of one or more connected rolling shutter switches. Surface installation with repositionable stickers (supplied) or onto a flush mounting box. Integrated LED for low battery indication. Powered by battery 3V type CR2032 (supplied) with an autonomy of 8 years - 2 modules</p>

Item	No-Battery wireless controls
○ 28003CWG	 <p>Wireless IP55 light switch No-Battery</p>
○ 28027CWG	 <p>Wireless IP55 shutter switch. No-Battery</p>

Item	Motion sensor wireless
○ 3585C	 <p>It controls one or more devices connected for light control. Infrared detection with angle of 140°. Distance of the adjustable sensor from 2 to 8 m. Switch off delay with 1 to 30 min adjustable delay time and 1 to 1000 lux brightness threshold. Test possible with a 5 sec. delay Recommended assembly height: 2.5 m. Optimum distance between 2 detectors: 6 m. For indoor and outdoor use (IP44). Supplied with 2 1.5V AA batteries for power supply.</p>
<p><b>Cover</b> <b>2 modules</b></p>	
<input type="checkbox"/> KW42M2 <input checked="" type="checkbox"/> KG42M2 <input type="checkbox"/> KM42M2  <input checked="" type="checkbox"/> KC42M2 <input checked="" type="checkbox"/> KS42M2 <input checked="" type="checkbox"/> KB42M2	 Cover for item K4003CW
<input type="checkbox"/> KW36M2 <input checked="" type="checkbox"/> KG36M2 <input type="checkbox"/> KM36M2  <input checked="" type="checkbox"/> KC36M2 <input checked="" type="checkbox"/> KS36M2 <input checked="" type="checkbox"/> KB36M2	 Cover for item K4003DCW
<input type="checkbox"/> KW39M2 <input checked="" type="checkbox"/> KG39M2 <input type="checkbox"/> KM39M2  <input checked="" type="checkbox"/> KC39M2 <input checked="" type="checkbox"/> KS39M2 <input checked="" type="checkbox"/> KB39M2	 Cover for item K4007CW



Devices to be completed with appropriate covers as indicated below





Item	Wireless Home/Away scenario controls	Item	Cover
<input type="radio"/> K4570CW  <p>Home / Away wireless switch. It is equipped with 2 buttons for activating Home / Away scenarios Scenarios can be customized by the Home + Control app. Surface installation with repositionable stickers (supplied) or onto a flush mounting box. Integrated LED for low battery indication. Powered by battery 3V type CR2032 (supplied) with an autonomy of 8 years - 2 modules</p>	<p><b>Wireless Home/Away scenario controls</b></p>	<input type="checkbox"/> KW40M2 <input checked="" type="checkbox"/> KG40M2 <input type="checkbox"/> KM40M2  <input checked="" type="checkbox"/> KC40M2 <input checked="" type="checkbox"/> KS40M2 <input checked="" type="checkbox"/> KB40M2  <input type="checkbox"/> KW41M2 <input checked="" type="checkbox"/> KG41M2 <input type="checkbox"/> KM41M2  <input checked="" type="checkbox"/> KC41M2 <input checked="" type="checkbox"/> KS41M2 <input checked="" type="checkbox"/> KB41M2  <input type="checkbox"/> KW37M2 <input checked="" type="checkbox"/> KG37M2 <input type="checkbox"/> KM37M2  <input checked="" type="checkbox"/> KC37M2 <input checked="" type="checkbox"/> KS37M2 <input checked="" type="checkbox"/> KB37M2	<p><b>2 modules</b></p> <p> Cover for item K4570CW</p> <p> Cover for item K4574CW</p> <p> Cover for item K4575CW</p>
<input type="radio"/> K4574CW  <p>It is equipped with 2 buttons for activating Wake Up / Sleep scenarios. Scenarios can be customized by the Home + Control app. Surface installation with repositionable stickers (supplied) or onto a flush mounting box. Integrated LED for low battery indication. Powered by battery 3V type CR2032 (supplied) with an autonomy of 8 years - 2 modules</p>	<p><b>Wireless Wake Up / Sleep scenario controls</b></p>		
<input type="radio"/> K4575CW  <p>It's equipped with 4 buttons for activating of scenarios 1,2,3 and 4. Scenarios can be customized by the Home+ Control app. Surface installation with repositionable stickers (supplied) or onto a flushmounting box. Integrated LED for low battery indication. Powered by battery 3V type CR2032 (supplied) with an autonomy of 8 years - 2 modules.</p>	<p><b>Wireless 4 scenarios control</b></p>		
<input type="radio"/> 3528C  <p>It allows to add a wireless remote control in your system. Is equipped with 4 keys for the activation of the 1,2,3 and 4 scenarios. The scenarios can be activated and customized by the Home + Control app. Integrated LED for low battery indication. Powered by battery 3V type CR2032 (supplied) with an autonomy of 8 years.</p>	<p><b>Pocket remote control 4 scenarios</b></p>		

# Living Now with Netatmo smart electrical system - EUROPEAN VERSION

connected sensors for temperature management and home protection







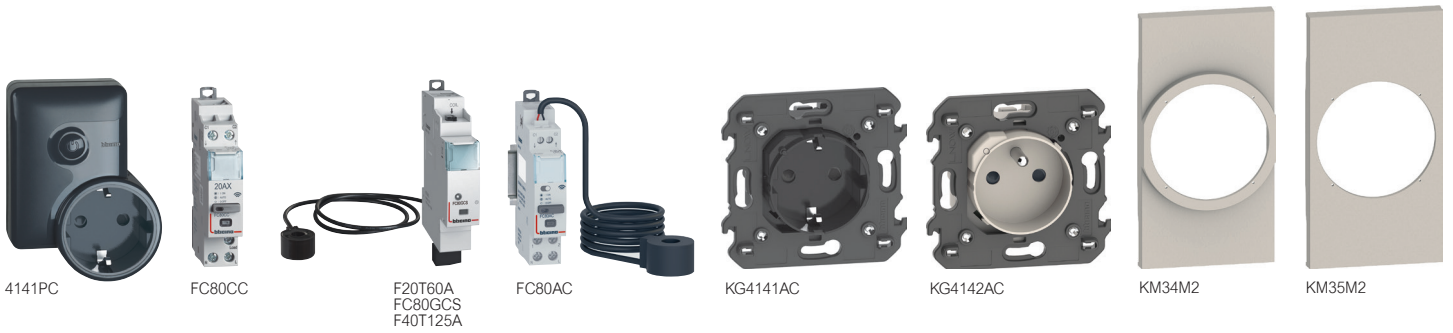





Devices to be completed with appropriate covers as indicated below

Item	Internal temperature and humidity sensor	Item	Cover
<input type="radio"/> <b>K4587C</b>  <p>Wireless indoor temperature and humidity sensor. Measures the temperature and humidity of the environment where it is installed and displays the data via the Home+Control app. Surface-mounted installation using repositionable adhesive strips (included) or on flush-mounted boxes. Powered by a 3V CR2032 battery (included). Size: 2 modules.</p>		<input type="checkbox"/> <b>KW45M2</b> <input checked="" type="checkbox"/> <b>KG45M2</b> <input type="checkbox"/> <b>KM45M2</b>  <input checked="" type="checkbox"/> <b>KC45M2</b> <input checked="" type="checkbox"/> <b>KS45M2</b> <input checked="" type="checkbox"/> <b>KB45M2</b>	<b>2 modules</b>  <p>Cover for temperature and humidity sensor item K4587C.</p>
<input checked="" type="checkbox"/> <b>3588GC</b>  <input type="checkbox"/> <b>3588SC</b> <input type="checkbox"/> <b>3588WC</b>	<b>External temperature and brightness sensor</b>  <p>Wireless outdoor temperature and light sensor. Measures outdoor temperature and light intensity, viewable via Home+Control app. Powered by 3.2V AAA battery (included), rechargeable through integrated solar panel. Surface wall installation with screw mounting. Grey finish.</p> <p>As above, beige As above, white</p>		
<input type="radio"/> <b>3590C</b>	 <p><b>Water leak sensor</b> Wireless water leak sensor. Detects leaks and notifies the user via Home+Control app. Equipped with buzzer for acoustic feedback. Surface installation using supplied adhesive. Powered by 3V CR2032 battery (included).</p>		
<input type="checkbox"/> <b>3591WC</b>  <input checked="" type="checkbox"/> <b>3591BC</b>	 <p><b>Wireless door and window opening sensor.</b> Wireless door and window opening sensor. Detects open/closed status and sends feedback to the system, which can use it to manage scenarios and actions set by the user via Home+Control app. Powered by 3V CR2032 battery (included). Surface installation using supplied adhesive strips or screw mounting. White finish.</p> <p>As above, black</p>		



Devices to be completed with appropriate covers as indicated below



Item	Connected module for energy management
○ 4141PC	 <p>Mobile connected German standard power outlet -plug&amp;play-. Directly connected to an existing socket, it allows remote control of all the connected electrical appliances. It also monitors the instantaneous, daily and monthly consumption. Compatible with all the devices with power up to 16 A 3680 W (with overload protection). It can be associated to wireless light controls. Power supply 110-230 V~</p>
○ 4142PC	 <p>As above French/belgian standard socket.</p>
○ FC80CC	 <p>Connected contactor for single-phase and/or three-phase loads with maximum absorption <math>I_n = 20</math> A. With meter for the measurement of the current absorbed by the load. Power supply 110-230 V~ - 1 DIN module</p>
○ F20T60A	 <p>Connected DIN meter. It allows to measure the energy consumption of the house electric installation (instantaneous, daily, monthly). It is also possible to receive notifications in case of exceeded the maximum power provided by your contract to avoid possible black-out. A toroid is provided to read the current. Power supply 110-230 V~ - 1 DIN module</p>
○ F40T125A	 <p>As above. Three-phase module</p>
○ FC80GCS	 <p>Connected DIN load management module for the monitoring of the consumptions of the whole electric system, the powering or disconnection of the loads, and the setting of scenarios with priority or non-priority loads. When the maximum intended power is reached, the non-priority loads are temporarily disconnected to avoid black-outs. A toroid for the current reading is provided. Power supply 110-230 V~ - 1 DIN module</p>
○ FC80AC	 <p>Smart device for controlling and measuring the consumption of equipment fitted with dry contacts. Rating 12V/30Vdc or 230Vac 2A max. Ideal for controlling and measuring heating appliances, wallboxes and electric vehicle charging stations, ventilation systems, irrigation systems and any other device with a control dry contact. Not suitable for shutter automation. A toroid is supplied, for the measurement of the current absorbed by the load, max 80A. Function management through the Home + Control App, compatible with load management module FC80GCS. 1 DIN module. 100-240V a.c. power supply 50/60 Hz. Requires a Zigbee gateway.</p>

Item	Connected socket
<input type="checkbox"/> KW4141AC <input checked="" type="checkbox"/> KG4141AC <input type="checkbox"/> KM4141AC  <input checked="" type="checkbox"/> KC4141AC <input checked="" type="checkbox"/> KS4141AC <input checked="" type="checkbox"/> KB4141AC	 <p>2P+E 16 A 250 Va.c. German standard connected socket. It allows remote control of electric devices and also to monitor their consumption (instantaneous, daily, monthly). It is also possible to receive notifications that can be configured. Compatible with all the electric devices with power up to 16 A 3680W (with overload protection). Integrated with a 2-module support, it can be installed instead of an existing socket in a 40 mm deep box. Screw fixing and connection using automatic clamps It has a blue LED that lights up when the socket is ON and that can be configured by means of the Home + Control App. It can be associated to one or more wireless light controls. Power supply 110-230 VA</p>
<input type="checkbox"/> KW4142AC <input checked="" type="checkbox"/> KG4142AC <input type="checkbox"/> KM4142AC  <input checked="" type="checkbox"/> KC4142AC <input checked="" type="checkbox"/> KS4142AC <input checked="" type="checkbox"/> KB4142AC	 <p>As above French/belgian standard socket</p>
<input type="checkbox"/> KW34M2 <input checked="" type="checkbox"/> KG34M2 <input type="checkbox"/> KM34M2  <input checked="" type="checkbox"/> KC34M2 <input checked="" type="checkbox"/> KS34M2 <input checked="" type="checkbox"/> KB34M2	<p><b>Cover for connected socket</b> <b>2 modules</b></p>  <p>Cover for item KW4141AC Cover for item KG4141AC Cover for item KM4141AC</p> <p>Cover for item KC4141AC Cover for item KS4141AC Cover for item KB4141AC</p>
<input type="checkbox"/> KW35M2 <input checked="" type="checkbox"/> KG35M2 <input type="checkbox"/> KM35M2  <input checked="" type="checkbox"/> KC35M2 <input checked="" type="checkbox"/> KS35M2 <input checked="" type="checkbox"/> KB35M2	 <p>Cover for item KW4142AC Cover for item KG4142AC Cover for item KM4142AC</p> <p>Cover for item KC4142AC Cover for item KS4142AC Cover for item KB4142AC</p>

# Living Now with Netatmo

## connected thermostat for air conditioning



Item	Connected thermostat for air conditioning
<input type="checkbox"/> XW8003 <input type="checkbox"/> XM8003 <input checked="" type="checkbox"/> XG8003	 <p>The Smarter AC with Netatmo connected thermostat, together with the Home + Control APP, is a device which allows to precisely and accurately adjust and monitor the temperature in the rooms; all the programming and most of the functions can be easily and intuitively performed using the App. Thanks to its Wi-Fi connection, Smarter AC can be programmed and controlled remotely; it can also display the temperature, fan speed and humidity measured in the room. The temperature level can be set locally for manual operation and Boost mode can be activated. The Boost forces the switching on of the system for a limited time (15, 30 or 45 minutes) irrespective of the measured and programmed temperature.</p> <p>Smarter AC with Netatmo can also be controlled with Google, Amazon Alexa and Apple Home Kit voice assistants.</p> <ul style="list-style-type: none"> <li>- Power supply 110 to 240 V~ , 50/60 Hz;</li> <li>- 2 W max absorption;</li> <li>- Maximum cable section 1 x 1.5 mm<sup>2</sup>;</li> <li>- Operating temperature 5 to 40 °C;</li> <li>- 1-switching contact output free of 5(2)A potential.</li> <li>- Type of operation 1BU</li> <li>- Pollution index 2</li> <li>- Rated pulse voltage 4 kV</li> <li>- Wireless device in compliance with 802.11b/g/n standard, frequency 2.4 - 2.4835 GHz, transmission power &lt; 20 dBm. WEP/WPA/WPA2 safety protocol IPv4.</li> <li>- Radio link: short range communication, frequency 868MHz/915MHz, transmission power &lt; 25mW e.r.p. (*).</li> </ul> <p>Types of installation</p> <ul style="list-style-type: none"> <li>- flush mounted, on boxes item 503E or 500 (for item 500 use the wall dowels)</li> <li>- plasterboard, on boxes item PB503 and PB502</li> </ul> <p>Available in three colours: white (XW8003), sand (XM8003) and black (XG8003).</p>
<input type="checkbox"/> XW8003W	 <p>Features: as XW8003. Installation: on the wall, using screws and dowels suitable for the installation surface (brickwork, plasterboard, tiles etc.). It is available only in white colour.</p>

Note(\*): 868MHz/915MHz radio link not available in Malaysia, China, Japan, Singapore and Taiwan.



### Voice assistants and apps for managing functions



### BTicino app for configuring and controlling functions



White (KW)    Black (KG)    Sand (KM)    Neutral item (K) (without cover)

Item	Actuator for fan coil unit
<input type="checkbox"/> 0 489 10	 <p>This actuator can be used in combination with Smarter AC with Netatmo on thermoregulation installations, to control different load types according to requirements.</p> <p>This DIN actuator can control:</p> <ul style="list-style-type: none"> <li>• 2-pipe fan coil unit with On/Off valve</li> <li>• 2-pipe fan coil unit with 3-way valve</li> <li>• 2-pipe fan coil unit with 0-10 V valve</li> <li>• 4-pipe fan coil unit with two On/Off valves</li> <li>• 4-pipe fan coil unit with two 3-way valves</li> <li>• 4-pipe fan coil unit with two 0-10 V valves</li> <li>• 3-speed fan</li> <li>• 1 0-10 V fan</li> </ul>
<input type="checkbox"/> 3460IR	 <p><b>IR interface for air conditioning unit</b></p> <p>Connected IR emitter for air conditioning. The installation with Smarter AC allows the smart management of an A/C unit with infrared. The device size is 60x60x30 mm, white color and it is provided with a white cable (length 1,5 m). It supports both power sources: 5÷12 Vd.c. and 110-240V ~ 50/60Hz. It communicates with Smarter AC through RF 2.4 GHz: thanks to its features, the emitter can be placed on the receiver of the A/C unit, ensuring perfect communication.</p>

# Living Now with Netatmo

## connected thermostats



XW8002



XM8002



XG8002



XW8002W

### Connected thermostats

Item
<input type="checkbox"/> XW8002
<input type="checkbox"/> XM8002
<input checked="" type="checkbox"/> XG8002
<input type="checkbox"/> XW8002W



The Smarter with Netatmo connected thermostat, together with the dedicated Home +Control App, is a device which allows you to adjust and monitor the temperature in the rooms precisely and accurately; all the programming and most of the functions are performed simply and intuitively using the APP. Thanks to its Wi-Fi connection, Smarter with Netatmo can be programmed and controlled remotely; it can also display the temperature and humidity measured in the room. The temperature level can be set locally for manual operation and the Boost mode can be activated. The Boost forces the switching on of the system for a limited time (30, 60 or 90 minutes) independent of the measured and programmed temperature. It's also possible to set a different temperature in each room of the house for the maximum comfort, thanks to its compatibility with Netatmo's smart radiator valves. Smarter with Netatmo can also be controlled with Google, Amazon Alexa and Apple Home Kit voice assistants.

**Features:**

- 110 ÷ 230 V~, 50/60 Hz power supply;
- 2 W max absorption;
- maximum cable section 1 x 1.5 mm<sup>2</sup>;
- temperature measurement 5 ÷ 40 °C;
- temperature set-point 5 ÷ 40 °C,
- increase of 0.5 °C;
- 1-contact output in switching free of potential 5(2) A.
- Radio link: short range communication, frequency 868MHz/915MHz, transmission power < 25mW e.r.p. (\*).

**Types of installation:**

- flush mounted, on boxes item 503E or 500 (for item 500 use the wall dowels)
- plasterboard, on boxes 2 module e 3 module

It is available in three colours: white (XW8002), sand (XM8002) and black (XG8002).

features: as ..8002.



Installation: on the wall, using screws and dowels suitable for the installation surface (brickwork, plasterboard, tiles etc.). It is only available in white.

**Note(\*):** 868MHz/915MHz radio link not available in Malaysia, China, Japan, Singapore and Taiwan.

### Voice assistants and apps for managing functions



### BTicino app for configuring and controlling functions



White (KW)    Black (KG)    Sand (KM)    Neutral item (K) (without cover)

# Living Now with Netatmo

## Smart radiator valves



NAV-PRO

NVP-PRO

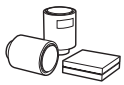
Articolo	Smart radiator valves for Smarter thermostat
<ul style="list-style-type: none"> <li>○ NAV-PRO</li> </ul>	 <p>Smart radiator valve with intelligent functions. E-Paper screen. Transparent plexiglass cylinder designed by Starck®; to be customized with one of the 4 colored adhesive films provided. Possibility of adjusting the temperature directly on the heads, reaching the desired temperature in every room of the house. Battery powered. Compatible with Netatmo Smart Modulating Thermostat and Smarter with Netatmo by BTicino</p>
<ul style="list-style-type: none"> <li>○ NVP-PRO</li> </ul>	 <p>Starter Pack for central heating - Smart Radiator Valves. Kit composed by 2 Smart Radiator valves and 1 Relays. Ideal for apartments with central heating or district heating</p> <p>Allows accurate temperature measurement without additional sensors in the rooms thanks to two integrated sensors B34 and PID (advanced algorithm) for precise temperature control. Compatible with 90% of radiators on the market, including Danfoss, Heimeier, Honeywell and other brands.</p> <p>Features of Smart Radiator Valves with Intelligent functions: E-Paper screen; transparent plexiglass cylinder designed by Starck® (can be customized with one of 4 colored adhesive films provided).</p>

■ Diagram of a typical Hotel room architecture

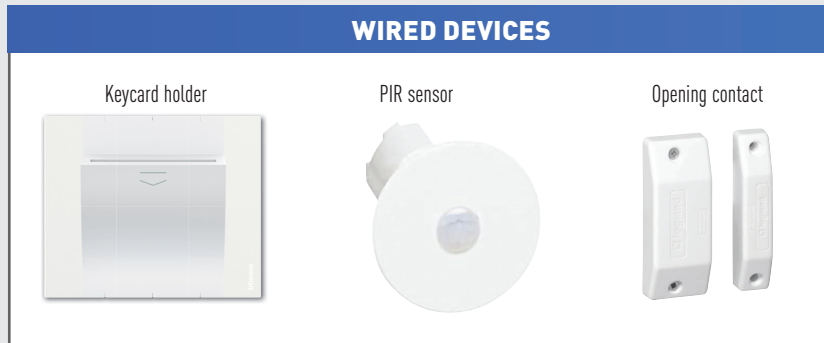

Connected to the thermostat by means of physical connection



The radio devices communicate with a frequency of 2.4 GHz



# Living Now Uxone

connected devices for the hotel



4 650 15



4 650 24



4 650 80



0 489 09



4 650 23

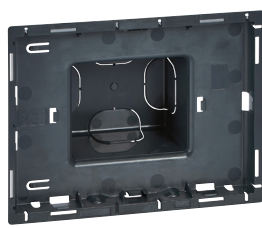

0 489 90



0 489 92

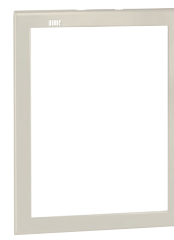

0 489 84  
(Example of customised sand colour frame)

Item	UXOne
4 650 15 4 650 24	<p>UXOne <b>flush mounted</b> connected thermostat for Hotels with backlit display, plastic material. It can be used for the air conditioning control of different types of systems, and the adjustment of the fan speed when Fancoils are used. Inputs available for door/window contact, bathroom alarm, keycard switch. A 12 Vdc output is available. Integrated DND and MUR pushbutton, WIFI connection. 230V power supply Size: 3 modules.</p> <p>● Black ○ White</p>
4 650 23 4 650 25	<p>UXOne thermostat as above - <b>surface mounted</b></p> <p>● Black ○ White</p>
0 489 09	<p>The web pages of the Hotel Server can be used to monitor the following room functions:</p> <ul style="list-style-type: none"> <li>- occupancy</li> <li>- do not disturb ( DND), make up the room (MUR), generic service request (e.g. laundry collection, room service)</li> <li>- Temperature control.</li> </ul> <p>It also allows to change the temperature inside the room and run scenarios. The Hotel Server also allows integration with third-party systems (e.g. via the MQTT protocol). Two IP connections for internal and external connectivity. It can be connected to the Eliot cloud for the update of the firmware. Power supply 230 Vac</p>

Item	UXOne
4 650 80	<p>UXOne <b>flush mounted</b> connected thermostat for Hotels with backlit display, <b>CUSTOMISED</b>, plastic material. It can be used for the air conditioning control of different types of systems, and the adjustment of the fan speed when Fancoils are used. Inputs available for door/window contact, bathroom alarm, keycard switch. A 12 Vdc output is available. 3 integrated customisable pushbuttons, WIFI connection. 230V power supply Size: 3 modules. For the customisation, use the software: UX for Hotels</p> <p>○ White</p>
4 650 82	<p>UXOne thermostat as above - <b>surface mounted</b></p> <p>○ White</p>
0 489 90	<p>UXOne accessory for installing the UXOne hotel thermostat flush with the wall surface.</p>
0 489 91 0 489 92 0 489 84	<p>UXOne finishing frame for use with the accessory for installation flush with the wall surface, item no. 048990</p> <p>● Black ○ White ○ Customisable</p>

# Living Now Uxone

connected devices for the hotel



0 489 10



0 884 20



0 038 02



3575C



3584C





0 485 75





3585C

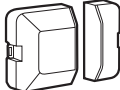

0 487 78

Item	UXOne
0 485 75	 <p>Radio technology white magnetic sensor for controlling the opening and closing of doors and windows.</p>
3585C	 <p>Motion sensor, it controls one or more devices connected for light control. Infrared detection with angle of 140 ° Distance of the adjustable sensor from 2 to 8 m. Switch off delay with 1 to 30 min adjustable delay time and 1 to 1000 lux brightness threshold. Test possible with a 5 sec. delay Recommended assembly height: 2.5 m. Optimum distance between 2 detectors: 6 m. For indoor and outdoor use (IP44). Supplied with 2 1.5V AA batteries for power supply.</p>
0 487 78	 <p>PIR technology sensor for the activation of the "VIRTUAL KEYCARD" function. The VIRTUAL KEYCARD function gives the possibility of activating the functions inside the room through the detection of the presence of an individual in the room, without the need to use the keycard switch. The sensor is stand-alone and is not connected to the SCS-BUS (power supply 8 - 30 Vdc); it also has a NO contact output (8 - 30 Vdc - max applicable voltage). Surface mounted or ceiling installation, diameter 25 mm. When installed on the ceiling at a height of 2.5 m, it covers a range of 5 m.</p>

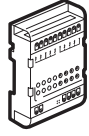
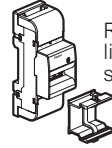
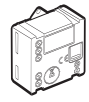
Item	UXOne
0 884 20	 <p>Radio technology micro module interface for the connection of a wired stand-alone keycard switch. 230V power supply Size: Basic module for hidden installation.</p>
3575C	 <p>Radio technology wireless contact interface for converting an existing switch into a connected switch, or for an auxiliary contact. Supplied with replaceable battery with a life of 8 years. Installation in the <b>flush mounted</b> switch box, behind the mechanism. Size: Basic module for concealed installation.</p>
0 489 10	 <p>Radio technology temperature controller actuator for heating and/or cooling zone management. When connected wirelessly to the UXOne thermostat, the system can control the temperature of a heating or cooling zone. Various configuration modes for managing 2-pipe and 4-pipe systems, and ON-OFF, 3-way and 1-10V valves. Power supply 230 Vac 4 DIN modules.</p>
0 038 02	 <p>Radio technology actuator for ON/OFF control of 2 light loads up to 1000W with 1 NC contact, power supply 230V. 2 DIN modules.</p>
3584C	 <p>Connected light relay actuator using Radio technology. It controls the lights locally or remotely with 1 NC contact. It is compatible with all loads with power up to 300 W. It can be connected to one or more traditional pushbuttons, or it can be associated to one or more wireless controls. It is installed like a traditional relay inside the flush mounted box (behind the pushbutton), or in junction boxes. Caution: neutral connection is necessary. Power supply 110-230 Va.c. Size: Basic module for hidden installation</p>

**Note:** the average battery life is one year under typical usage conditions. This duration may vary depending on usage intensity. Under low-intensity operating conditions, battery life may slightly increase. To ensure optimal performance and expected battery longevity, it is recommended that the device connects to the radio network immediately after removing the pull tab or as soon as the batteries are inserted.

# Living Now Uxone

wired and wireless device for room management



Devices to be completed with appropriate covers as indicated below

Item	Wireless Wake Up scenario controls	Cover
<input type="radio"/> K4574CW <p>It is equipped with 2 buttons for activating Wake Up / Sleep scenarios. Scenarios can be customized by the Home + Control app. Surface installation with repositionable stickers (supplied) or onto a flush mounting box. Integrated LED for low battery indication. Powered by battery 3V type CR2032 (supplied) with an autonomy of 8 years - 2 modules</p>	<input type="checkbox"/> KW01D <input type="checkbox"/> KG01D <input type="checkbox"/> KM01D <input type="checkbox"/> KC01D <input type="checkbox"/> KS01D <input type="checkbox"/> KB01D	<b>1 module - bell symbol</b> Cover bell white for item K4027HC
<input type="radio"/> K4575CW <p>It's equipped with 4 buttons for activating of scenarios 1,2,3 and 4. Scenarios can be customized by the Home+ Control app. Surface installation with repositionable stickers (supplied) or onto a flushmounting box. Integrated LED for low battery indication. Powered by battery 3V type CR2032 (supplied) with an autonomy of 8 years - 2 modules.</p>	<input type="checkbox"/> KW41M2 <input type="checkbox"/> KG41M2 <input type="checkbox"/> KM41M2 <input type="checkbox"/> KC41M2 <input type="checkbox"/> KS41M2 <input type="checkbox"/> KB41M2	<b>2 modules</b> Cover for item K4574CW
<input type="radio"/> K4373C <p>Do not disturb and Make up room room command - Radio technology</p>	<input type="checkbox"/> KW37M2 <input type="checkbox"/> KG37M2 <input type="checkbox"/> KM37M2 <input type="checkbox"/> KC37M2 <input type="checkbox"/> KS37M2 <input type="checkbox"/> KB37M2	Cover for item K4575CW - scenarios 1,2,3 and 4
<input type="radio"/> K4027HC <p>Do not disturb and Make up room corridor indicator and bell function - Radio technology.</p>	<input type="checkbox"/> KW44M2 <input type="checkbox"/> KG44M2 <input type="checkbox"/> KM44M2 <input type="checkbox"/> KC44M2 <input type="checkbox"/> KS44M2 <input type="checkbox"/> KB44M2	Cover for item K4575CW - scenarios Day, Night, TV, Read
<input type="radio"/> K4548 <p>Key card switch for the power supply inside the hotel room - slot light with built-in lamp - 30 second switch-off delay - power supply 230 V~ - with RFID technology recognition. The completion of the light point requires two "half-module blanking modules" (item K4949) at the sides of the badge holder.</p>	<input type="checkbox"/> KW22M2 <input type="checkbox"/> KG22M2 <input type="checkbox"/> KM22M2 <input type="checkbox"/> KC22M2 <input type="checkbox"/> KS22M2 <input type="checkbox"/> KB22M2	Cover for item K4548 and K4549
<input type="radio"/> K4549 <p>Key card switch for the power supply inside the hotel room - slot light with built-in lamp - 30 second switch-off delay - power supply 230 V~. The completion of the light point requires two "half-module blanking modules" (item K4949) at the sides of the badge holder.</p>	<input type="checkbox"/> KW22 <input type="checkbox"/> KG22 <input type="checkbox"/> KM22 <input type="checkbox"/> KC22 <input type="checkbox"/> KS22 <input type="checkbox"/> KB22	<b>3 modules</b> Cover for item K4548 and K4549
<input type="checkbox"/> KW11H <input type="checkbox"/> KG11H <input type="checkbox"/> KM11H <input type="checkbox"/> KC11H <input type="checkbox"/> KS11H <input type="checkbox"/> KB11H <input type="checkbox"/> KW11HC <input type="checkbox"/> KG11HC <input type="checkbox"/> KM11HC <input type="checkbox"/> KC11HC <input type="checkbox"/> KS11HC <input type="checkbox"/> KB11HC	<b>Cover</b> <b>1 module</b> Cover DND MUR for item K4027HC  Cover DND MUR for item K4373C	

**Note:** the average battery life is one year under typical usage conditions. This duration may vary depending on usage intensity. Under low-intensity operating conditions, battery life may slightly increase. To ensure optimal performance and expected battery longevity, it is recommended that the device connects to the radio network immediately after removing the pull tab or as soon as the batteries are inserted.

# Living Now MyHOME

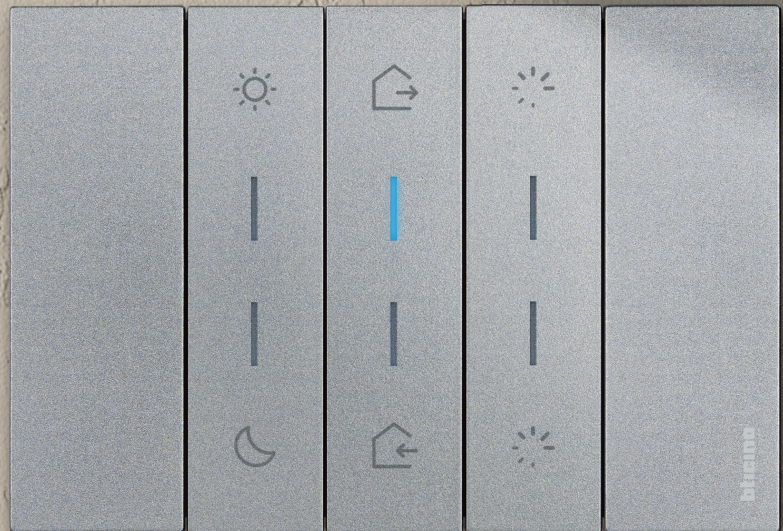

## SECTION 3

Living Now MyHOME

# Devices based on the BTicino SCS bus.

## Wired home automation for advanced systems and new builds.

How to choose devices for the composition of the electrical system

### SECTION 3

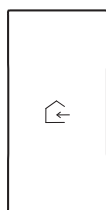
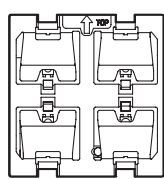
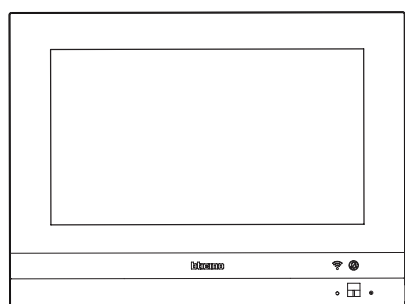

### SECTION 1

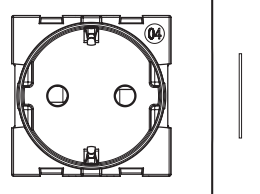
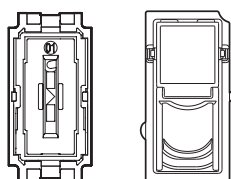



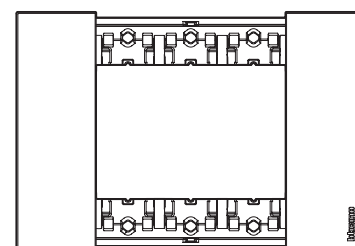
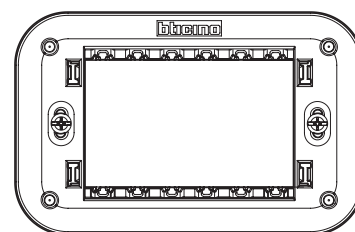







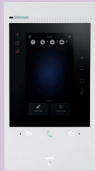

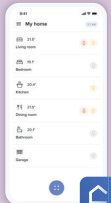









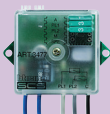

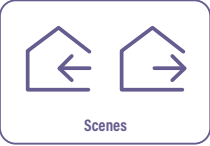



### SECTION 5

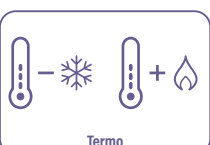

Type of system	Catalog section
Living Now standard system (Switches, sockets and cover plates for the residential electrical system)	1 + 5
Living Now with Netatmo (Connected controls for the smart home, which communicate via radio)	2 + 1 + 5
<b>Living Now MyHOME</b> <b>(Advanced Smart Home controls, which communicate via SCS BTicino bus)</b>	<b>3 + 1 + 5</b>
Living Now KNX (Connected controls for the smart home, which communicate via KNX standard bus)	4 + 1 + 5
Living Now electrical system completion (cover plates range, boxes, accessories)	5

Table of choice

Functions	Control devices (27 Vd.c. by BUS)				
 <p>Internet connection</p>	<div style="display: flex; justify-content: space-between; align-items: flex-start;"> <div style="text-align: center;">  <p>Server F460</p> </div> <div style="text-align: center;">  <p>Classe 300E0S 344842 (white) 344884 (black)</p> </div> <div style="text-align: center;">  <p>works with Google Home works with alexa</p> </div> <div style="text-align: center;">  <p>Home + Control</p> </div> <div style="text-align: center;">  <p>Home + Project</p> </div> </div>				
 <p>Light</p>	<div style="display: flex; justify-content: space-around; align-items: flex-start;"> <div style="text-align: center;">  <p>Control devices K4652M2 K4652M2M (multifunction)</p> </div> <div style="text-align: center;">  <p>Control devices K4652M3 K4652M3M (multifunction)</p> </div> <div style="text-align: center;">  <p>Basic contact interface 3477</p> </div> <div style="text-align: center;">  <p>DIN contact interface F428</p> </div> </div>				
 <p>Electrical shutters</p>	<div style="display: flex; justify-content: space-around; align-items: flex-start;"> <div style="text-align: center;">  <p>Control devices K4652M2 K4652M2M (multifunction)</p> </div> <div style="text-align: center;">  <p>Control devices K4652M3 K4652M3M (multifunction)</p> </div> <div style="text-align: center;">  <p>Basic contact interface 3477</p> </div> <div style="text-align: center;">  <p>DIN contact interface F428</p> </div> </div>				
 <p>Scenes</p>	<div style="display: flex; justify-content: space-around; align-items: flex-start;"> <div style="text-align: center;">  <p>Control devices K4652M2 K4652M2M (multifunction)</p> </div> <div style="text-align: center;">  <p>Control devices K4652M3 K4652M3M (multifunction)</p> </div> <div style="text-align: center;">  <p>Basic contact interface 3477</p> </div> <div style="text-align: center;">  <p>DIN contact interface F428</p> </div> <div style="text-align: center;">  <p>Scenarios module F420</p> </div> </div>				
 <p>Energy management and monitoring</p>	<div style="display: flex; justify-content: space-around; align-items: flex-start;"> <div style="text-align: center;">  <p>Energy meter F520</p> </div> <div style="text-align: center;">  <p>Impulse counter interface 3522N</p> </div> <div style="text-align: center;">  <p>Load control central F521</p> </div> </div>				
 <p>Thermo</p>	<div style="display: flex; justify-content: space-around; align-items: flex-start;"> <div style="text-align: center;">  <p>Thermostat ...4691</p> </div> <div style="text-align: center;">  <p>Probe without display 3454</p> </div> </div>				

**NOTE:** complete the installation with the appropriate power supply item E56 or item E49.

**Actuator devices (BUS: 27 Vd.c. - Power line: 230 V~)**



Actuator/control  
K4672M2L  
K4672M2LM (multifunction)



Relay actuator  
3476



Relay actuator  
F411/INC



1-output dimmer  
F413N



2 relay actuator  
F411U2



4 relay actuator  
F411/4



Multi-load dimmer  
F416U1 (1 output)  
F418U2 (2 output)



ON/OFF actuator  
«zero crossing»  
BMSW1003  
BMSW1005



F429G (DALI-2 gateway)  
F429D (DALI-2 dimmer)



Actuator/control  
K4672M2S  
K4672M2SM (multifunction)



2 relay actuator  
F401



2 relay actuator  
F411U2



4 relay actuator  
F411/4



Actuator for management  
of the load F522



1 relay actuator «zero crossing» for  
management of the load F523



2 relay actuator  
F430/2



4 relay actuator  
F430/4



8 relay actuator  
F430R8



Actuator with 3  
relays and 2x0-10Volt  
output F430R3V10



Actuator with 2x0-10 Volt  
Outputs F430V10

# Living Now MyHOME

diagram of a typical MyHOME system

System with web server F460 and use of Hometouch as a video internal unit.

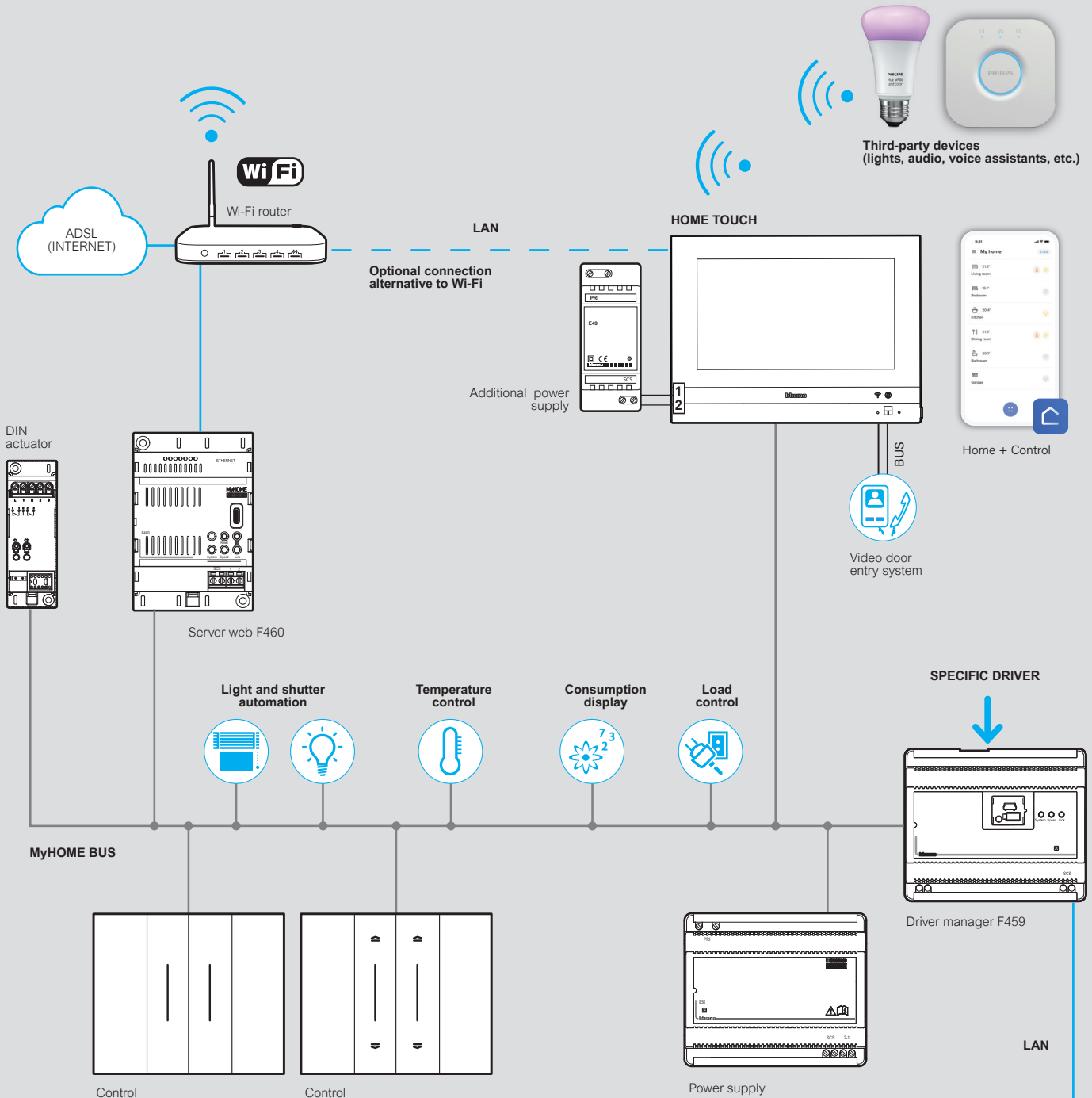

**Third-party devices and systems**

Air conditioning system

Sensors, measurement devices etc.

- LAN Wi-Fi network
- Grey BUS cable
- Network cable
- White BUS cable

# Living Now MyHOME

## integration and control



F460





F461



F459

Item	MyHOME Server
○ F460	 <p>The new SCS server is a device designed to interact with the MyHOME system; It allows to create and realize high level installation to manage BUS SCS Smart Home solutions occupying less DIN modules (4), key for MyHome business to have a solution optimized for the cabinet. It has natively integrated the capability of humidity management and It natively supports 175 addresses with the possibility of extension by adding max 2 BT-F422A interfaces SCS. The Server is suitable for:</p> <ul style="list-style-type: none"> <li>- devices association during the system starting-up by the installer in Home+Project app. Concerning the Lights, Automation, Temperature Control and Energy systems, the system is started via the Server directly using the Home + Project application (It allows you to configure the system also without internet).</li> <li>- for the local and remote management of the functions by the user with the specific Home + Control app for Android and iOS smartphones and vocal compatibility with Alexa® e Google® is possible to manage the Myhome System or 3rd party devices (ex. Interact with lamps Philips Hue®, Lixf®, ...). It can perform customisations and create scenarios for managing the MyHOME system.</li> </ul> <p>The server can be combined with a physical interface used as VDE internal unit and Touchscreen to control the installation (HomeTouch) - 4 DIN modules.</p>

○ F461	 <p><b>MyHOME Server 3rd Parties integration</b></p> <p>A dedicated version of 4 DIN server open to third party that supports the use and integration of the 3rdParties systems. It has native protocol to provide local integration in 3rd party systems, for advanced Home Automations systems like for instance RTI, Crestron, Control4, Savant with high value and complexity. Use the Home + Project app to start configuring the server, while for the usage it will be not Home + Control but the 3rd parties app. It's alternative to F460</p>
--------	---

○ F459	 <p><b>Driver manager</b></p> <p>Integration platform with other brand systems - 6 DIN modules It requires the installation of specially designed driver for the integration of the system.</p>
--------	--

Contact the BTicino System Integration Service to check the feasibility of specific integrations and to request the licence needed to use the Driver manager.

### Voice assistants and apps for managing functions

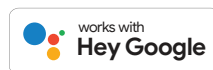

### BTicino app for configuring and controlling functions



**Home + Project**  
For the installer



**Home + Control**  
For the user



**Door entry for Hometouch**  
For the end customer. For video intercom management in systems with HOMETOUCH used as an internal video intercom unit and using the F460 server.



Item

- 344842
- 344884
- 344844
- 346020

**CLASSE 300EOS with Netatmo connected video internal unit**



2 wires/Wi-Fi handsfree connected video internal unit with built-in Amazon Alexa voice assistant, 5" vertical touch screen LCD display and video door entry answering machine. It has a physical key for door lock release and capacitive keys for the control of the main video door entry functions: handsfree communication, entrance panel activation / camera scrolling and Favourite key (can be configured to activate the quick actions most frequently used – e.g. additional door locks, staircase light control, intercom). There are notification LEDs for: Wi-Fi network connection status, info / notifications and call exclusion. It is possible to easily interact with the built-in Alexa voice assistant, either using the dedicated capacitive keys or with your voice, and activate several functions, such as the video door entry functions, Smart Home, scenarios, reminders etc. Using the touch display, it is possible to access the notification list, as well as your favourite door entry, security and Smart Home controls (if any). The device must be configured by physically connecting the configurators or using the menu, which will give better possibilities of customisation of associated functions and texts. Thanks to the Wi-Fi connection, you can associate the video internal unit to the Home + Security App (available for Android and iOS). The App allows to use the main video internal unit functions (receiving calls, door lock release, display of the event timeline and activation of the entrance panel/camera cycling). Through the Home + Security App, it is also possible to manage the products of the Netatmo security range (outdoor and indoor cameras, door and window sensors, indoor siren and smoke detector). This allows you to quickly and easily create a Smart security system. The device also allows to create and manage Smart Home functions using the wired SCS BUS solution, without the need for adding dedicated webserver. Wall mounted installation using the supplied bracket Possibility of Wi-Fi connection or using RJ45 ethernet cable with the dedicated accessory 344844. White

As above - black

**Ethernet accessory**



Accessory cable for wired connection of Classe 300EOS with Netatmo video internal unit via RJ45 Ethernet cable. To be purchased separately.

**2 DIN Additional power supply**

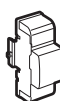

Additional power supply to be used to supply entrance panels and internal units locally. 2 DIN modular enclosure. Power supply 230 V~ at 50-60 Hz. The output provides 27 Vdc continuous low voltage, with maximum current of 600 mA and it is protected on the PRI side (with fuse) against overload and short circuit. It is a SELV double insulation safety device.

**System with Classe 300EOS with Netatmo as server as an alternative to the server item F460**

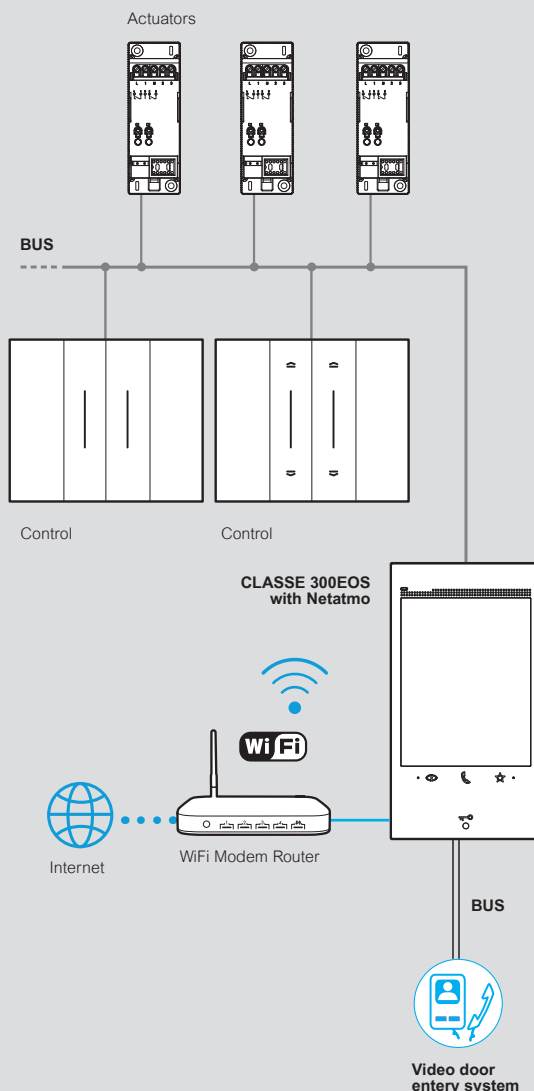

**Voice assistants and apps for managing functions**



**BTicino app for configuring and controlling functions**

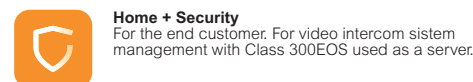

# Living Now MyHOME



## integration and control



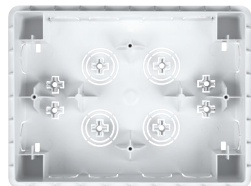





3488









3487

Item	<b>HOMETOUCH - Touch screen 7"</b>
○ 3488	 <p>HOMETOUCH - Touch Screen 7" for the management of all MyHOME functions, that can be integrated with the video door entry system and with indoor and outdoor Netatmo cameras, to be used as connected internal unit. To use the home automation functions, configuration is not necessary. It is possible to display the MyHOME system status and control the integrated functions (lights, automation, scenarios, burglar alarm, temperature management, Nuvo music system, ...). Thanks to the "DOOR ENTRY for HOMETOUCH" application, available both for Android and iOS operating systems, it is also possible to manage the video door entry functions of a BTicino 2 wires system using the 7" capacitive display or the Smartphone. Flush mounted installation with box for masonry walls (item 3487) or wall mounted installation with the supplied metal bracket. Tech grey.</p>
○ 3488W	As above - white
○ 3487	<p><b>Box for flush mounted installation</b></p>  <p>Box for flush mounted installation of the HOMETOUCH Touch screen item 3488 and 3488W. Width 197 mm, height 148 mm and depth 52 mm.</p>
○ 3487AP	 <p>Support for flush mounted installation on plasterboard walls of the HOMETOUCH Touch screen item 3488 and 3488W.</p>



Item	Voice control
<input type="checkbox"/> KW8013 <input checked="" type="checkbox"/> KG8013 <input type="checkbox"/> KM8013	 Amazon Alexa digital control device with voice assistant, including two touch controls for lighting management. 27 Vd.c. power supply from BUS through connection module item KW8001 or additional power supply unit, item K8003 - 3 modules
<input type="checkbox"/> K8003	<b>Power supply</b>  Connection module with additional power supply dedicated to Voice control Alexa built-in item KW/KG/KM8013 - 2 modules
<input type="checkbox"/> KW8010 <input checked="" type="checkbox"/> KG8010 <input type="checkbox"/> KM8010	<b>Light control</b>  Touch control for the management of ON/OFF light functions. One single control can manage from 1 to 2 functions between single lights, light groups or general lights. - 1 module
<input type="checkbox"/> KW8011 <input checked="" type="checkbox"/> KG8011 <input type="checkbox"/> KM8011	<b>Full control</b>  Touch control for the management from 1 to 3 functions between: lights on/off, load control, dimmer, shutters up/down with or without preset, NUVO Player and scenarios. It can also be used as group or general control. It has on-board proximity sensor that allows the display of function icons/symbols when approaching the control - 1 module
<input type="checkbox"/> K8002L <input type="checkbox"/> K8002S	<b>ON/OFF actuators for lights and for shutters</b>  Flush-mounted actuator with 2 independent and neutral relays for "zero crossing" function - single or double 230 V~ loads - 1 module  Flush-mounted shutter actuator with 2 independent relays. It allows the management of a specific shutter position. Through the control KW/KG/KM8011, together with the UP/DOWN function monostable and bistable, the actuator also places the shutter in a stored (PRESET) position - 1 module
<input type="checkbox"/> K8001	<b>Connection modules</b>  Device for the power supply of controls and actuators through electrified frame item KW/KG/KM8103 KW/KG/KM8103P1 KW/KG/KM8104 KW/KG/KM8104P1 KW/KG/KM8102P1

Item	Blanking module
<input type="checkbox"/> KW8100 <input checked="" type="checkbox"/> KG8100 <input type="checkbox"/> KM8100	 Cover for blanking module art. K4950 - 1 module
<input type="checkbox"/> KW8102P1 <input checked="" type="checkbox"/> KG8102P1 <input type="checkbox"/> KM8102P1	<b>Electrified frame for 2 module box</b>  Electrified frame with intermediate control separators (removable). For the installation of up to 3 digital controls or covers, item KW/KG/KM8100 in 2-module box with support K8102
<input type="checkbox"/> K8102	<b>Support for the 2-module box</b>  Support for the installation of the electrified frame item KW/KG/KM8102P1 in 2 module box.
<input type="checkbox"/> KW8103 <input checked="" type="checkbox"/> KG8103 <input type="checkbox"/> KM8103	<b>Electrified frames for 3 and 4 module boxes</b>  Electrified frame with intermediate control separators (removable). For the installation of up to 3 digital controls or covers, item KW/KG/KM8100 in 3-module box with support K4703
<input type="checkbox"/> KW8103P1 <input checked="" type="checkbox"/> KG8103P1 <input type="checkbox"/> KM8103P1	 Electrified frame with intermediate control separators (removable). For the installation of up to 4 digital controls or covers, item KW/KG/KM8100 in 3-module box with support K4703
<input type="checkbox"/> KW8104 <input checked="" type="checkbox"/> KG8104 <input type="checkbox"/> KM8104	 Electrified frame with intermediate control separators (removable). For the installation of up to 4 digital controls or covers, item KW/KG/KM8100 in 4-module box with support K4704
<input type="checkbox"/> KW8104P1 <input checked="" type="checkbox"/> KG8104P1 <input type="checkbox"/> KM8104P1	 Electrified frame with intermediate control separators (removable). For the installation of up to 5 digital controls or covers, item KW/KG/KM8100 in 4-module box with support K4704

# Living Now MyHOME

## lights and shutter automation



K4652M2  
K4652M2M

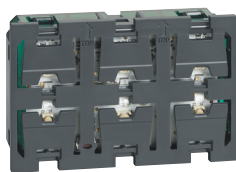

K4652M3



K4672M2L  
K4672M2LM



K4672M2S  
K4672M2SM

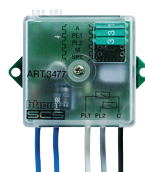

3477



F428



KMD01MH



KMD02MH

Devices to be completed with appropriate covers as indicated below

Item	Control devices
<input type="radio"/> K4652M2	Control for the management of one or two ON/OFF functions, the shutter UP/DOWN function and the adjustment of a dimmer load. It can also be used as scenario control and for the call to the floor, staircase light switching on and door lock activation functions. It manages advanced shutter functions. - 2 modules. To be completed with 1 or 2-module covers.
<input type="radio"/> K4652M2M	Device as above - multifunction version to manage up to 4 functions. To be completed with 1 module covers.
<input type="radio"/> K4652M3	Control for the management of up to three separate functions as described above - 3 modules. To be completed with 1 or 2-module covers.
<input type="radio"/> K4652M3M	Device as above - multifunction version to manage up to 6 functions. To be completed with 1 module covers.

Item	Actuator/control for lights and generic loads
<input type="radio"/> K4672M2L	Actuator/control with 2 independent relays for single or double loads: The device can be also configured to manage a remote actuator with the same functions of the K4652M2 and K4652M3 controls - 2 modules. To be completed with 1 or 2-module covers.
<input type="radio"/> K4672M2LM	Actuator/control with 2 independent relays for single or double loads: The device can be also configured to manage a remote actuator with the same functions of the K4652M2M and K4652M3M controls - 2 modules. To be completed with 1 module covers.

Item	Dali2 control devices
<input type="radio"/> K4653M2	2-module flush mounted control, dedicated to the management of Dali2 lights through up to 4 ambiances (A,B,C,D): the ambience is a group of Dali2 lights with a specific setting of each light that can be recalled by this push button and from the Home + Control App. With a short press you set the ambience and with a long press you change the dimming level of each light of the ambience, proportionally to their specific level. To be completed with 2 1-module dedicated key covers.
<input type="radio"/> K4653M3	3-module flush-mounted control dedicated to the management of Dali2 lights such as the K4653M2 item (using 2 specific 1-module key covers) and to the management of other MyHOME functions (using a specific 1-module key cover).

Item	Actuator/control for shutter
<input type="radio"/> K4672M2S	Shutter actuator with 2 internal relay 2 A 250 V~. In addition to the monostable and bistable UP/DOWN function, the actuator also places the rolling shutter in a stored (PRESET) position. The device can be also configured to manage a remote actuator - 2 modules. To be completed with 1 or 2-module covers.
<input type="radio"/> K4672M2SM	Shutter actuator with 2 internal relay 2 A 250 V~. In addition to the monostable and bistable UP/DOWN function, the actuator also places the rolling shutter in a stored (PRESET) position. The device can be also configured to manage a remote actuator with the same functions of the K4652M2M and K4652M3M controls - 2 modules. To be completed with 1 module covers.

Item	Contact interface
<input type="radio"/> 3477	Basic module control interface with 2 independent contacts for the control of 2 actuators for single function loads, or 1 actuator for double function loads (shutters) - the inputs accepts two traditional switches or pushbuttons with NO and NC contact, or a traditional two-way switch, or interlocked pushbuttons.
<input type="radio"/> F428	As above - 2 DIN modules

Item	Covers for dali2 control devices
<input type="checkbox"/> KWD01MH	1 module - for control item K4653M2 and K4653M3 silk-screen printing environment A and B
<input type="checkbox"/> KGD01MH	
<input type="checkbox"/> KMD01MH	
<input type="checkbox"/> KCD01MH	silk-screen printing environment C and D
<input type="checkbox"/> KSD01MH	
<input type="checkbox"/> KBD01MH	
<input type="checkbox"/> KWD02MH	silk-screen printing environment C and D
<input type="checkbox"/> KGD02MH	
<input type="checkbox"/> KMD02MH	
<input type="checkbox"/> KCD02MH	silk-screen printing environment C and D
<input type="checkbox"/> KSD02MH	
<input type="checkbox"/> KBD02MH	

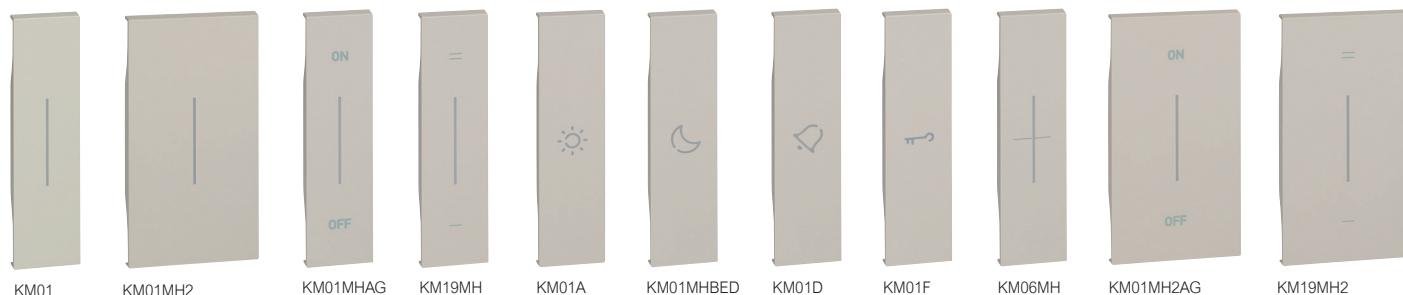

- Item**
- KW01
  - KG01
  - KM01
  
  - KC01
  - KS01
  - KB01
  
  - KW01MH2
  - KG01MH2
  - KM01MH2
  
  - KC01MH2
  - KS01MH2
  - KB01MH2

**Cover without symbols**

**1 module**

Lightable cover for item K4652M2, K4652M3 and K4672M2L

**2 modules**

Lightable cover for item K4652M2 and K4672M2L

**Cover with symbols**

**1 module**

Lightable cover for item K4652M2, K4652M3 and K4672M2L

- KW01MHAG
- KG01MHAG
- KM01MHAG

ON/OFFfunction silk-screen printing

- KC01MHAG
- KS01MHAG
- KB01MHAG

- KW19MH
- KG19MH
- KM19MH

DIMMER function screen printing. The symbols - and = indicate respectively decreasing and increasing the light intensity.

- KC19MH
- KS19MH
- KB19MH

- KW01A
- KG01A
- KM01A

LIGHT/WAKE UP symbol

- KW01MHBED
- KG01MHBED
- KM01MHBED

BED symbol

- KW01MHGEN
- KG01MHGEN
- KM01MHGEN

GOING OUT symbol

- Item**
- KW01MHBAC
  - KG01MHBAC
  - KM01MHBAC
  
  - KW01D
  - KG01D
  - KM01D
  
  - KW01F
  - KG01F
  - KM01F

**Cover with symbols**

COMING IN symbol

BELL symbol

KEY symbol

**1 module**

Lightable cover for item K4652M2, K4652M3 and K4672M2S

- KW05
- KG05
- KM05

UP/DOWN silk-screen printing for shutters

- KC05
- KS05
- KB05

- KW06MH
- KG06MH
- KM06MH

STOP symbol silk-screen printing for shutters

- KC06MH
- KS06MH
- KB06MH

**2 modules**

Lightable cover for item K4652M2 and K4672M2L

- KW01MH2AG
- KG01MH2AG
- KM01MH2AG

ON/OFFfunction silk-screen printing

- KC01MH2AG
- KS01MH2AG
- KB01MH2AG

- KW19MH2
- KG19MH2
- KM19MH2

DIMMER function screen printing. The symbols - and = indicate respectively decreasing and increasing the light intensity.

- KC19MH2
- KS19MH2
- KB19MH2

- KW01MH2A
- KG01MH2A
- KM01MH2A

LIGHT/WAKE UP symbol







KM01MH2BED KM01MH2GEN KM01MH2D KM01MH2F KM05MH2 KMM01MH KMM20MH KMM21MH KMM22MHK KMM23MH

- | Item  |
|---|
| <input type="checkbox"/> KW01MH2BED             |
| <input checked="" type="checkbox"/> KG01MH2BED  |
| <input type="checkbox"/> KM01MH2BED             |
| <input type="checkbox"/> KW01MH2GEN             |
| <input checked="" type="checkbox"/> KG01MH2GEN  |
| <input type="checkbox"/> KM01MH2GEN             |
| <input type="checkbox"/> KW01MH2BACK            |
| <input checked="" type="checkbox"/> KG01MH2BACK |
| <input type="checkbox"/> KM01MH2BACK            |
| <input type="checkbox"/> KW01MH2D               |
| <input checked="" type="checkbox"/> KG01MH2D    |
| <input type="checkbox"/> KM01MH2D               |
| <input type="checkbox"/> KW01MH2F               |
| <input checked="" type="checkbox"/> KG01MH2F    |
| <input type="checkbox"/> KM01MH2F               |
| <input type="checkbox"/> KW05MH2                |
| <input checked="" type="checkbox"/> KG05MH2     |
| <input type="checkbox"/> KM05MH2                |
| <input checked="" type="checkbox"/> KC05MH2     |
| <input checked="" type="checkbox"/> KS05MH2     |
| <input checked="" type="checkbox"/> KB05MH2     |

**Cover with symbols**

**2 modules**

**Lighttable cover for item K4652M2 and K4672M2L**

-  BED symbol
-  GOING OUT symbol
-  COMING IN symbol
-  BELL symbol
-  KEY symbol

**Lighttable cover for item K4652M2 and K4672M2S**

-  UP/DOWN silk-screen printing

**Blank cover for multifunction controls**

**1 module**

-  Lighttable cover with 2 functions for commands items K4652M2M, K4652M3M and actuators items K4672M2LM e K4672M2SM

- KWM01MH
- KGM01MH
- KMM01MH
- KCM01MH
- KSM01MH
- KBM01MH

- | Item  |
|---|
| <input type="checkbox"/> KWM20MH            |
| <input checked="" type="checkbox"/> KGM20MH |
| <input type="checkbox"/> KMM20MH            |
| <input checked="" type="checkbox"/> KCM20MH |
| <input checked="" type="checkbox"/> KSM20MH |
| <input checked="" type="checkbox"/> KBM20MH |
| <input type="checkbox"/> KWM21MH            |
| <input checked="" type="checkbox"/> KGM21MH |
| <input type="checkbox"/> KMM21MH            |
| <input checked="" type="checkbox"/> KCM21MH |
| <input checked="" type="checkbox"/> KSM21MH |
| <input checked="" type="checkbox"/> KBM21MH |
| <input type="checkbox"/> KWM22MH            |
| <input checked="" type="checkbox"/> KGM22MH |
| <input type="checkbox"/> KMM22MH            |
| <input checked="" type="checkbox"/> KCM22MH |
| <input checked="" type="checkbox"/> KSM22MH |
| <input checked="" type="checkbox"/> KBM22MH |
| <input type="checkbox"/> KWM23MH            |
| <input checked="" type="checkbox"/> KGM23MH |
| <input type="checkbox"/> KMM23MH            |
| <input checked="" type="checkbox"/> KCM23MH |
| <input checked="" type="checkbox"/> KSM23MH |
| <input checked="" type="checkbox"/> KBM23MH |
| <input type="checkbox"/> KWM24MH            |
| <input checked="" type="checkbox"/> KGM24MH |
| <input type="checkbox"/> KMM24MH            |
| <input checked="" type="checkbox"/> KCM24MH |
| <input checked="" type="checkbox"/> KSM24MH |
| <input checked="" type="checkbox"/> KBM24MH |

**Cover with symbols for multifunction controls**

**1 module**

**Cover for actuator item K4672M2LM, controls items K4652M2LM and K4652M3M**

-  silk-screen printing «2 dimmer»

-  Lighttable cover SILK-SCREEN PRINTING "EXIT-RETURN"

-  Lighttable cover SILK-SCREEN PRINTING "NIGHT-DAY"

-  Lighttable cover silk-screen printing "SCENARIO 1 AND 2"

-  Lighttable cover SILK-SCREEN PRINTING "SCENARIO 3 AND 4"

## Living Now MyHOME

actuators for lights, shutters and different loads



Item	Light control/actuator
○ 3476	1 relay actuator - for single loads: 2 A resistive or incandescence lamps, 2 A cosφ 0.5 for ferromagnetic transformers - a traditional pushbutton with NO contact accepted in input
○ F411U2	<b>Actuators for centralisations</b> Actuator with 2 independent relays – for single and double loads: 10 A resistive and 6 A incandescence lamps, 500 W for reducer motors, 2 A cosφ 0.5 for ferromagnetic transformers and 250 W for fluorescent lamps - logic relay interlock via configuration - it has "Zero crossing" technology - 2 DIN modules
○ F411/4	Actuator with 4 independent relays - for single, double or mixed loads: 2 A resistive, 2 A cosφ 0.5 for ferromagnetic transformers and 70 W for fluorescent lamps - logic relay interlock via configuration - 2 DIN modules
○ F411/1NC	Actuator with 1 two-way NC relay for single loads, 16 A resistive, 10 A for incandescence lamps, and 4 A for fluorescent lamps. At switch on, the contact of the device is always closed (ON status), and it opens when an OFF control is sent. In this way, if there is no power input from the BUS, the device will remain in the ON status, keeping the load ON - 2 DIN modules

Item	Actuators for centralisations
○ BMSW1003	ON/OFF actuator, 4 independent outputs with maximum load 16 A at 230 V~, clamp connection and RJ45, IP20 protection index, power supply 100/240 V~ 50/60 Hz, pushbuttons for load direct control - zero-crossing function - 6 DIN modules
○ BMSW1005	ON/OFF actuator, "Zero Crossing" technology, 8 independent outputs with maximum load 16 A at 230 V~, clamp connection, IP20 protection index, power supply 100/240 V~ 50/60 Hz, pushbuttons for load direct control - 10 DIN modules
○ F401	<b>Actuator for shutters</b> Actuator with 2 internal relays and 4 pushbuttons. In addition to monostable and bistable UP/DOWN operation, the actuator also places the shutter in a stored (PRESET) position - 2 DIN modules

### Loads that can be driven (250 VA 50/60 Hz)

Actuators	Type						
	Energy saving incandescence and halogen lamps	LED lamps	Linear fluorescent lamps <sup>1)</sup>	Compact fluorescent lamps	Electronic transformers <sup>3)</sup>	Ferromagnetic transformers <sup>2) 3)</sup>	Reducer motors for shutters <sup>4)</sup>
3476	2 A 460 W	40 W Max 1 lamp	- -	40 W Max 1 lamp	- -	2 A cosφ 0,5 460 VA	-
F411U2	10 A 1380 W	250 W Max 4 lamps	4 A 230 W	250 W Max 4 lamps	4 A 230 W	4 A cosφ 0,5 460 VA	2 A 460 W
F411/4	2 A 460 W	70 W Max 2 lamps	0.3 A 70 W	70 W Max 2 lamps	0.3 A 70 W	2 A cosφ 0,5 460 VA	2 A 460 W
BMSW1003	16 A 3680 W	2.1 A 500 VA	10 X (2 X 36 W) 4.3 A	1150 W 5 A	16 A 3680 W	16 A 3680 W	-
BMSW1005	16 A 3680 W	2.1 A 500 VA	4.3 A 10X2X36 W	5 A 1150 VA	16 A 3680 W	16 A 3680 W	-
F401							2 A 250 V~
F411/1NC	10 A 2300 W	500 W Max 10 lamps	4 A 920 W	500 W Max 10 lamps	4 A 920 W	4 A cosφ 0,5 920 VA	



**Notes:**  
 1) Power factor corrected fluorescent lamps, discharge lamps. 2) Account must be taken of the transformer yield to calculate the effective power of the load connected to the actuator. For example if a dimmer is connected to a 100 VA ferromagnetic transformer with yield 0.8, the effective power of the load will be 125 VA. 3) The transformer must be loaded at its rated power and however never less than 90% of this power. It is preferable to use a single transformer rather than several transformers in parallel. For example it is better to use a single 250 VA transformer with 5 50W spotlights connected rather than use 5 50 VA transformers in parallel each with a 50 W spotlight. 4) The symbol on the actuators refers to the shutter reducer motors.



○ Neutral item (K) (without cover)

# Living Now MyHOME

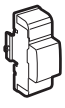



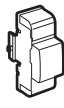

## dimmer actuators for lights and different loads



Item	Dimmers for centralisations
○ F413N	 <p>1-output dimmer to supply fluorescent lamps or LED sources with input 1-10 V for single loads up to 2.5 A at 230 V~ – type of screw connection - power supply 27 Vd.c. – absorption 30 mA – max 10 ballast that can be connected (clamps 1-2) - with pushbutton for load direct control - version for fastening on DIN rail - 2 modules</p>
○ F416U1	<p><b>Multi-load dimmers for centralisations</b></p>  <p>Multi-load dimmer, 1 output with maximum load 4.3 A at 230 V~, clamp connection and RJ45, IP20 protection index, power supply 100/240 V~ 50/60 Hz, pushbutton for load direct control - 6 DIN modules</p>
○ F418U2	 <p>Two-channel dimmer for the management of dimmer LEDs, dimmer compact fluorescent lamps (CFL), energy saving halogen lamps and electronic transformers at 110-230V. Possibility of parallelisation of the two channels to increase the maximum power which can be managed. power supply 27 Vd.c., absorption 18 mA - version for fastening on DIN rail - 4 modules</p>

Item	Devices for DALI lamps management
○ F429G	 <p>DALI-2 Gateway - The device is an interface between MyHOME/Lighting Management systems and devices driven using the DALI (Digital Addressable Lighting Interface) protocol. It has 1 independent outputs to manage up to 64 ballast DALI2. The functionalities supported are: ON/OFF, dimmer, RGBW (colour and tunable white) e phase in-out. The device can be installed in a MyHOME system through H+P app configuration. Suitable in houses where the installation is made with all DalI2 lamps.</p>
○ F429D	 <p>DALI-2 dimmer - The device is an interface between MyHOME/Lighting Management systems and devices driven using the DALI (Digital Addressable Lighting Interface) protocol. It has 2 independent outputs to control up to 32 ballasts (2 groups of 16 DALI-2 lamps). The functionalities supported are: ON/OFF, dimmer, RGBW (colour and tunable white) e phase in-out. The device can be installed in a MyHOME system through H+P app configuration. Suitable for installations with few DALI-2 lamps.</p>

### Loads that can be driven (230 VA 50/60 Hz)

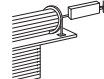
Actuators	Type						
							
	Energy saving incandescence and halogen lamps	LED lamps	Linear fluorescent lamps <sup>1)</sup>	Compact fluorescent lamps	Electronic transformers <sup>3)</sup>	Ferromagnetic transformers <sup>2) 3)</sup>	Reducer motors for shutters <sup>4)</sup>
F413N	-	-	2 A 460 W <sup>5)</sup> Max 10 ballast, type T5, T8, compact or driver for LED	-	-	-	-
F416U1	4.3 A 40 - 1000 W	-	-	-	4.3 A 40 - 1000 W	4.3 A 40 - 1000 W	-
F418U2	2x300 W	2x300 VA	-	2x300 VA	2x300 VA	2x300 VA	-
F429G	SCS/DALI2 gateway – up to 64 ballast DALI2						
F429D	SCS/DALI2 dimmer – up to 64 ballast DALI2						

**Notes:**  
 1) Power factor corrected fluorescent lamps, discharge lamps. 2) Account must be taken of the transformer yield to calculate the effective power of the load connected to the actuator. For example if a dimmer is connected to a 100 VA ferromagnetic transformer with yield 0.8, the effective power of the load will be 125 VA. 3) The transformer must be loaded at its rated power and however never less than 90% of this power. It is preferable to use a single transformer rather than several transformers in parallel. For example it is better to use a single 250 VA transformer with 5 50W spotlights connected rather than use 5 50 VA transformers in parallel each with a 50 W spotlight. 4) The  symbol on the actuators refers to the shutter reducer motors. 5) Only compatible with lamps with 1/10 V ballast.



BMSE3001

BMSE3003

0 882 40

BMSO4003

K4649

KW17

KG17

Item
○ BMSE3001
○ BMSE3003

**Lighting/movement sensors**



Passive infrared SCS sensor for the detection of movement and the lighting level. Ceiling flush mounted installation using springs or installation boxes; surface installation using surface installation box, item 048875; IP20 protection index; RJ45 clamp connection; 8 m (50 m<sup>2</sup>) diameter coverage area for a 2.5 m installation height, maximum installation height 6 m; 27 Vd.c. power supply from bus, absorption 12 mA; regulation with basic/advanced remote control (BMSO4003 and BMSO4001) or through configuration software, of the lighting level, from 5 to 1275 LUX, of the time delay, from 30 s to 255 h, and of the main operating parameters; Push&Learn pushbutton



Double technology SCS sensor: passive infrared for the detection of presence and the lighting level. Ceiling flush mounted installation using springs or installation boxes; surface installation using surface installation box, item 048875; IP20 protection index; RJ45 clamp connection; 8 m diameter (50 m<sup>2</sup>) infrared coverage area for a 2.5 m installation height, 11 mm diameter (95 m<sup>2</sup>) ultrasound coverage area for a 2.5 m installation height, maximum installation height 6 m; 27 Vd.c. power supply from BUS, absorption 17 mA; regulation with basic/advanced remote control (BMSO4003 and BMSO4001), or through configuration software, of the lighting level, from 5 to 1275 LUX, of the delay, from 30 s to 255 h, and of the main operating parameters; Push&Learn pushbutton

Item
○ 0 882 40

**Remote control and configuration gateway**



The Gateway allows you to adjust the time delay, the brightness threshold and the detection sensitivity. Possibility to store, share, prepare all of the product settings for a construction site advance. Possibility of duplicating the parameters of a product 0 882 40. Works with the App "Legrand Close Up" available on Google Play and Apple Store via Bluetooth Low Energy technology for smartphone. Allows the configuration of windows, management systems lighting and emergency lighting units and offers advanced features to facilitate the management of facilities.

○ BMSO4003
------------

**Configuration remote controls**



The basic configuration remote control, with IR transmitter, adjusts the main operating parameters of: Switch Sensor, Green Switch and SCS compatible sensors. Modification of parameters only possible for preset values, battery recharge not available

○ 0 488 75
------------

**Installation accessories**

Ceiling mounted box compatible with the sensors: BMSE3001 and BMSE3003, IP20 protection index, dimensions Ø 100 x 50 mm

○ K4659
---------

**PIR passive infrared sensors**



Green Switch: passive IR (PIR) sensor, suitable for the detection of presence in transit areas (corridors, toilets, service rooms). Operating mode (automatic or manual), time delay (5 s to 59min), and brightness threshold (20 to 1275 LUX) settable using the advanced/basic (BMSO4001/BMSO4003) configuration remote control; physical or virtual configuration. - 2 modules

<input type="checkbox"/> KW17
<input checked="" type="checkbox"/> KG17
<input type="checkbox"/> KM17
<input checked="" type="checkbox"/> KC17
<input checked="" type="checkbox"/> KS17
<input checked="" type="checkbox"/> KB17

**Cover for item K4659**



White  
Black  
Sand

# Living Now MyHOME

## temperature control



KM4691



3454



F430/2

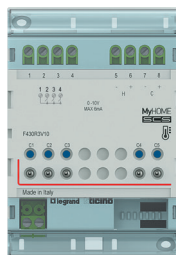

F430R8









F430V10

Devices to be completed with appropriate covers as indicated below

Item	Thermostat	Item	Probe without display
<input type="checkbox"/> KW4691 <input checked="" type="checkbox"/> KG4691 <input type="checkbox"/> KM4691 <input checked="" type="checkbox"/> KC4691 <input checked="" type="checkbox"/> KS4691 <input checked="" type="checkbox"/> KB4691	<p>Probe with backlit display that controls the temperature of an individual zone. It features an input for the connection of a contact line (e.g. window contact). It can be used for the management of different types of systems, and the adjustment of the fan speed when fan coils are used. Possibility of automatic operation (summer/winter), with compatible systems - 2 modules</p> <p>White Black Sand Champagne Steel Bronze</p>	<input type="radio"/> 3454	Temperature probe in basic module with wired sensor - to be associated to the temperature sensor item 3457 and Vantage probe item 8051
		<input type="radio"/> 3457	Temperature probe to be associated to the probe item 3454
		<input type="radio"/> F430/2  <input type="radio"/> F430/4  <input type="radio"/> F430R8  <input type="radio"/> F430R3V10  <input type="radio"/> F430V10	<p><b>Actuators</b></p> Actuator with 2 independent relays – for single and double loads: 6 A resistive, 2A motor driven valves and pumps - configuration based logic relay interlock - 2 DIN modules Actuator with 4 independent relays - for single, double or mixed loads: 4 A resistive, 1 A motor driven valves, pumps and fan coils - configuration based logic relay interlock - 2 DIN modules Actuator with 8 independent relays for the control of on-off valves, motorised valves (open-close and three points), pumps and fan coils with 2 and 4 tubes - 4A resistive, 1A motor valves, pumps and fan-coils- SCS-bus connection - 4 DIN modules Actuator with 3 independent relays and 2 x 0-10 Volts outputs for the control of fan coils with 2 and 4 tubes with proportional 0-10 Volt valves - 4A resistive, 1A fan coil - SCS-BUS connection - 4 DIN modules Actuator with 2 x 0-10 Volt outputs for the control of 0-10 proportional valves - SCS-BUS connection - 2 DIN modules



Item	Consumption display
○ F520	 Meter for the measurement of electricity on a maximum of 3 lines, by connecting 3 toroids to the appropriate inputs. Version for fastening on DIN rail. The device is fitted with 1 toroid. Data visualization with Home+Control app. - 1 module.
○ 3523	 Additional electricity meter toroid, item F520 and for actuator with sensor, item F522 for the measurement of the earth leakage current. Cable length 400 mm.
○ 3522N	 Impulse counter interface for the data measurement from meters (water, gas, etc..) with impulse output. The values measured can be displayed on all the MyHOME user interfaces (HOMETOUCH and Home + Control App). Basic module version for hidden installation. Power supply from BUS 27 V.





Item	Load control management
○ F521	 Central unit for the management and control of the actuators of the load control system, to prevent the risk of detachment of the limiter of the electricity supplier. The central unit manages up to 63 loads, a contract power between 1.5 and 18 kW, and tolerance up to +/- 20%. It integrates an electricity meter for the controlled line. Version for fastening on DIN rail. The device is fitted with 1 toroid. Data visualization with Home+Control App. - 1 module
○ F522	 Actuator with integrated current sensor for the measurement of the controlled load consumptions. 1 relay - 10 A for incandescence lamps and 4 A for fluorescent lamps or ferromagnetic transformers, and 500 W for compact fluorescent and LED lamps - Bistable relay with zero crossing for the Automation and/or Load control management functions. Version for fastening on DIN rail - 1 module. Earth leakage control by connecting the additional toroid, item 3523. Data visualization with Home+Control App.
○ F523	 1 relay actuator - for incandescence lamps and 4 A for fluorescent lamps or ferromagnetic transformers, and 500 W for compact fluorescent and LED lamps - bistable relay with zero crossing for the Automation and/or Load control management functions. Version for fastening on DIN rail Data visualization with Home+Control App. - 1 module.









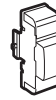

Item	Accessories
○ 3508BUS	 removable clamp for BUS connection - width 3.81 mm
○ 3508U2	 removable clamp 2 poles
○ 3508U3	 removable clamp 3 poles

# Living Now MyHOME

## power supply, accessory and cables



Item	SCS addresses extension interface
○ F422A	 <p>2 Din modules Interface between SCS BUS based systems, dedicated just to the logic expansion of the address extension and not to all the functions supported with the previous BT-F422. It can be used with both, DIN server BT-F460 and Classe300EOS with Netatmo. Each interface can add 175 addresses, with a maximum of 2 interfaces allowed for installation (BT-F460 with max 2 F422A; Classe300EOS with max +1 F422A). By doing so thanks to this device you will be able to overcome the current limit of 175 addresses and configure huge installations with up to 525 addresses. No parameters to take into consideration because the assignment is automatic.</p>
○ F422	<p><b>SCS interface for different systems</b></p>  <p>Interface between SCS BUS based systems, dedicated to different functions - 2 lowered DIN modules</p>
○ F420	<p><b>Scenario Module</b></p>  <p>Device enabling to save 16 scenarios for Automation, Temperature control and Video door entry applications - 2 DIN modules</p>
○ F425	<p><b>Memory Module</b></p>  <p>Module used for saving the status of the actuators - to reset the light automation system in case of power cut - 2 lowered DIN modules.</p>

Item	Power supply
○ E56	 <p>Power supply with input voltage 110 - 240 V~ @ 50 - 60 Hz. It provides two output power supplies in very low safety voltage (one of 27V DC 1.2A on the SCS terminals, one of 28.5V c.c. on terminal 1 - 2) to be used alternatively e NOT simultaneously. It can be used also as an additional power supply (output 1 - 2) for the local power supply of the devices automation (in this case it is not possible use no other output). The device is electronically protected against overload and short circuit. It is a device SELV double insulation safety device - Overall dimensions 6 DIN modules.</p>
○ E49	 <p>Compact power supply for Temperature control and Automation systems - input 230 V~, output 27 Vdc - maximum power delivered 600 mA - 2 DIN modules.</p>
○ L4669	<p><b>Connection cables</b></p>  <p>Sheathed pair made up of 2 flexible wires with unshielded plaited sheath - insulation 300/500 V - complies with standards CEI 46-5 and CEI 20-20 - coil length 100 metres</p>
○ L4669/500	 <p>as above - in 500 m coils</p>
○ L4669KM1	 <p>As above - reel length 1000 m</p>
○ 336904	 <p>Specific cable with 2 twisted conductors. It can be installed in underground piping, in accordance with standards (CEI 20-13 and CEI 20-14). It ensures the best performance in video systems (higher distance between EP and Handset when compared with other cables). 200 m coil</p>
○ 336905	 <p>As above - low toxicity cable without halogens - ideal for application in environments where fire hazard safety is critical - coil length 200 metres</p>
○ 3508BUS	<p><b>Accessories</b></p>  <p>removable clamp for BUS connection - width 3.81 mm</p>
○ 3508U2	 <p>removable clamp 2 poles</p>
○ 3508U3	 <p>removable clamp 3 poles</p>
○ 3515	 <p>spare removable clamp</p>

○ Neutral item (K) (without cover)

# Living Now KNX



## SECTION 4

Living Now KNX

# Devices based on KNX bus. Advanced control and full system integration for residential and tertiary applications.

How to choose devices for the composition of the electrical system

### SECTION 4

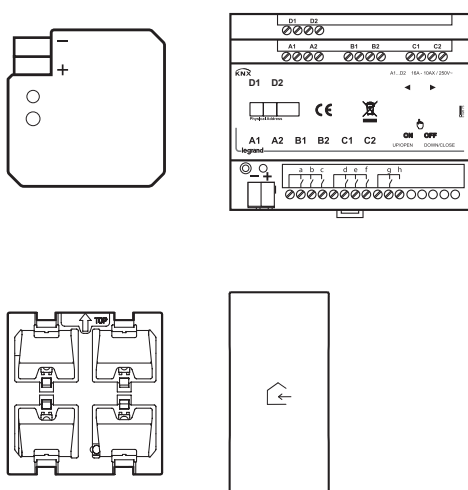

### SECTION 1

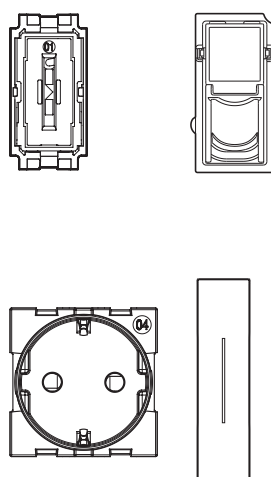

### SECTION 5

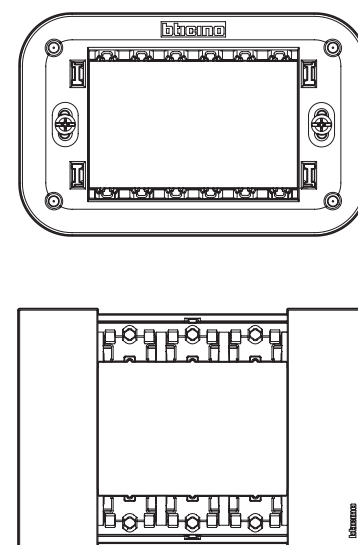

Type of system	Catalog section
Living Now standard system (Switches, sockets and cover plates for the residential electrical system)	1 + 5
Living Now with Netatmo (Connected controls for the smart home, which communicate via radio)	2 + 1 + 5
Living Now MyHOME (Advanced Smart Home controls, which communicate via SCS BTicino bus)	3 + 1 + 5
<b>Living Now KNX (Connected controls for the smart home, which communicate via KNX standard bus)</b>	<b>4 + 1 + 5</b>
Living Now electrical system completion (cover plates range, boxes, accessories)	5

# Living Now KNX

## KNX manual control units and thermoregulation



Connected directly to KNX cable (supplied with tap-off connector)  
The control unit must be programmed using ETS software

Item	Living Now wired control units KNX secure
K4651M2KNX	<p>Used to control (ON/OFF, dimming, scenario, forcing), roller shutters (up, down, stop), awnings, and other receivers. Fitted with programmable RGB LEDs (12 colors available) for displaying load status and system status feedback (normal, forced, override, day/night pilot light, etc.) and alarms</p> <p><b>4 channels control unit - 2 buttons</b></p> <p>To be fitted with Living Now key cover, plate and support frame</p>
K4652M2KNX	<p>To be fitted with Living Now key cover, plate and support frame - KNX Data Secure certified to protect building automation systems from unauthorized access and cyber attacks.</p>
K4651M3KNX	<p><b>6 channels control unit - 3 buttons</b></p> <p>To be fitted with Living Now key cover, plate and support frame</p>
K4652M3KNX	<p>To be fitted with Living Now key cover, plate and support frame - KNX Data Secure certified to protect building automation systems from unauthorized access and cyber attacks.</p>
0 029 00	<p><b>Touch screen control units</b></p> <p>With built-in temperature &amp; proximity sensor Max. 16 timings, 8 group events, 8 logic functions To be installed in a flush-mounting box 4" touch screen 9 control pages including switch, dimming, RGB, shutters, scene, HVAC and audio control, and energy metering</p>
0 029 01	<p>5" touch screen 15 control pages including switch, dimming, RGB, shutters, scene, HVAC and audio control, and energy metering</p>

Item	Display thermostat
KG4691F3KNX	<p>Living Now thermostat Flush-mounted backlight display with embedded temperature probe Used to manage different types of heating/cooling system (FCU, heating/cooling valve, fan, electric load, etc.) in combination through KNX with standard HVAC controller such as Cat.Nos 0 026 72/73/74/76/78/79 or 0 028 90) Monitoring of the ambient temperature Adjustment of the temperature set-point and/or fan speed Selection of operating mode To be installed in a flush-mounting box - 2 modules</p>
0 028 90	<p><b>Modular fan coil controller</b></p> <p>To control fan coil 2-4 pipes (with 0-10 V or ON-OFF valve and fan speed) or valves 2 x 0-10 V output 5 x 10 A outputs 1 input for PT1000 temperature sensor 4 DIN modules</p>

# Living Now KNX

## cover for 4 and 6 channels control unit

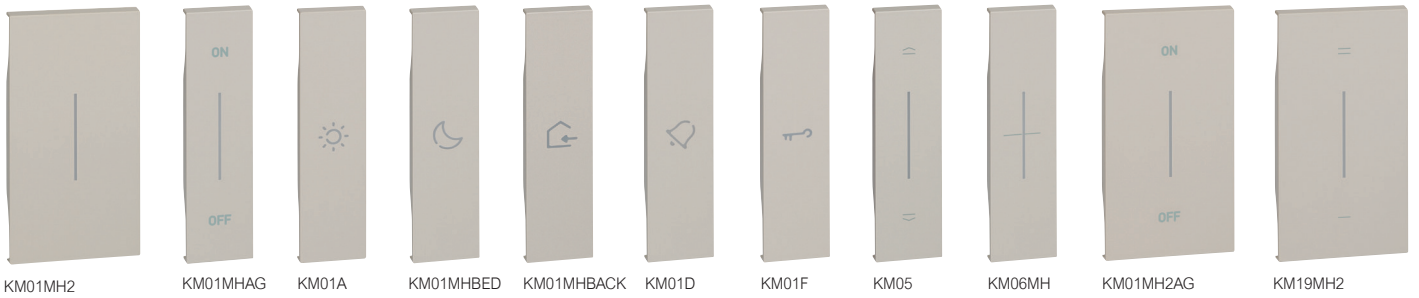

**Item** **Cover without symbols**

**1 module**  
 Lightable cover for item K4651M2KNX and K4651M3KNX

- KW01
- KG01
- KM01
- KC01
- KS01
- KB01

**2 modules**  
 Lightable cover for item K4651M2KNX and K4651M3KNX

- KW01MH2
- KG01MH2
- KM01MH2
- KC01MH2
- KS01MH2
- KB01MH2

**Cover with symbols**

**1 module**  
**Lightable cover for item K4651M2KNX and K4651M3KNX**  
 ON/OFF function silk-screen printing

- KW01MHAG
- KG01MHAG
- KM01MHAG
- KC01MHAG
- KS01MHAG
- KB01MHAG

DIMMER function screen printing. The symbols - and = indicate respectively decreasing and increasing the light intensity.

- KW19MH
- KG19MH
- KM19MH
- KC19MH
- KS19MH
- KB19MH

LIGHT/WAKE UP symbol

- KW01A
- KG01A
- KM01A

BED symbol

- KW01MHBED
- KG01MHBED
- KM01MHBED

GOING OUT symbol

- KW01MHGEN
- KG01MHGEN
- KM01MHGEN

**Item** **Cover with symbols**

- KW01MHBAC
- KG01MHBAC
- KM01MHBAC
- KW01D
- KG01D
- KM01D
- KW01F
- KG01F
- KM01F

COMING IN symbol

BELL symbol

KEY symbol

**1 module**  
**Lightable cover for item K4651M2KNX and K4651M3KNX**  
 UP/DOWN silk-screen printing for shutters

- KW05
- KG05
- KM05
- KC05
- KS05
- KB05

STOP symbol silk-screen printing for shutters

- KW06MH
- KG06MH
- KM06MH
- KC06MH
- KS06MH
- KB06MH

DIMMER function screen printing. The symbols - and = indicate respectively decreasing and increasing the light intensity.

- KW19MH2
- KG19MH2
- KM19MH2
- KC19MH2
- KS19MH2
- KB19MH2

**2 modules**  
**Lightable cover for item K4651M2KNX and K4651M3KNX**  
 ON/OFF function silk-screen printing

- KW01MH2AG
- KG01MH2AG
- KM01MH2AG
- KC01MH2AG
- KS01MH2AG
- KB01MH2AG

DIMMER function screen printing. The symbols - and = indicate respectively decreasing and increasing the light intensity.

- KW19MH2
- KG19MH2
- KM19MH2
- KC19MH2
- KS19MH2
- KB19MH2

LIGHT/WAKE UP symbol

- KW01MH2A
- KG01MH2A
- KM01MH2A

# Living Now KNX

cover for 4 and 6 channels control unit



**Item** **Cover with symbols**

**2 modules**  
**Lighttable cover for item K4651M2KNX and K4651M3KNX**

- KW01MH2BED
- KG01MH2BED
- KM01MH2BED
- KW01MH2GEN
- KG01MH2GEN
- KM01MH2GEN
- KW01MH2BACK
- KG01MH2BACK
- KM01MH2BACK
- KW01MH2D
- KG01MH2D
- KM01MH2D
- KW01MH2F
- KG01MH2F
- KM01MH2F
- KW05MH2
- KG05MH2
- KM05MH2
- KC05MH2
- KS05MH2
- KB05MH2

- BED symbol
- GOING OUT symbol
- COMING IN symbol
- BELL symbol
- KEY symbol
- UP/DOWN silk-screen printing

**Blank cover for multifunction controls item K4652M2KNX and K4652M3KNX**

**1 module**

- KWM01MH
- KGM01MH
- KMM01MH
- KCM01MH
- KSM01MH
- KBM01MH

- ON/OFF function

**Item** **Blank cover for multifunction controls item K4652M2KNX and K4652M3KNX**

**1 module**

- KWM20MH
- KGM20MH
- KMM20MH
- KCM20MH
- KSM20MH
- KBM20MH
- KWM21MH
- KGM21MH
- KMM21MH
- KCM21MH
- KSM21MH
- KBM21MH
- KWM22MH
- KGM22MH
- KMM22MH
- KCM22MH
- KSM22MH
- KBM22MH
- KWM23MH
- KGM23MH
- KMM23MH
- KCM23MH
- KSM23MH
- KBM23MH
- KWM24MH
- KGM24MH
- KMM24MH
- KCM24MH
- KSM24MH
- KBM24MH

- Lighttable cover silk-screen printing "2 DIMMER"
- Lighttable cover silk-screen printing "EXIT-RETURN"
- Lighttable cover silk-screen printing "NIGHT-DAY"
- Lighttable cover silk-screen printing «SCENARIO 1 and 2»
- Lighttable cover silk-screen printing «SCENARIO 3 and 4»

# Living Now KNX

## KNX sensors

**KNX**  
KNX certified



0 489 18



0 489 19



0 489 21

Constantly check for presence and light levels, switching OFF as soon as the natural light level is sufficient.

Switch ON and OFF automatically

Accurate set-up on site with configuration device

Connected directly to KNX cable (supplied with tap-off connector)

The detector must be programmed using ETS software







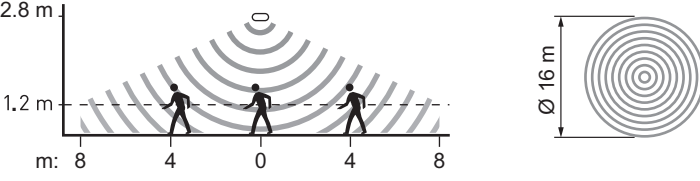

Item	Special presence sensors for work areas
0 489 18	Suitable for meeting rooms, classrooms, open areas, etc. <b>Ceiling mounted</b> 360° passive infrared and ultrasound detection, range 8 m IP 20 Fixes directly in suspended ceiling with springs (supplied) or is installed in a 50 mm deep Batibox flush-mounting box Surface mounted on ceiling using accessory Cat.Nos 0 488 75
0 489 22	360° passive infrared detection with high density lens, range 8 m IP 20 Fixes directly in suspended ceiling with springs (supplied) or is installed in a 50 mm deep Batibox flush-mounting box Surface mounted on ceiling using accessory Cat.No 0 488 75
CP-EBDSPIR-KNX	Connection by KNX red/black connector 360° passive infrared detection, range 7 m Flat and compact sensor for standard heights IP 40
CP-MWS6-KNX	Fixes directly in suspended ceiling with springs (supplied) 360° MW (microwave) detection, range 16 m Flat and compact sensor IP 40 Fixes directly in suspended ceiling with springs (supplied)

Item	Special sensors for corridor
0 489 19	<b>Ceiling mounted motion sensor</b> Double passive infrared detection 360°, lateral range 2 x 12 m IP 20 Recommended fixing height: 2.5 m Fits directly in suspended ceiling with springs (supplied) or is installed in a 50 mm deep Batibox flush-mounting box Cat.No 0 893 58 Surface mounted on ceiling using accessory Cat.No 0 488 75
CP-MWS3A-KNX	<b>Ceiling mounted presence sensor</b> MW (microwave) detection, range up to 23 m Flat and compact sensor with adjustable head for special applications IP 40 Recommended fixing height: 2.8 m Fixes directly in suspended ceiling with springs (supplied)
CP-EBDHS-KNX	<b>Special presence sensor for high bay</b> <b>Ceiling mounted</b> 360° passive infrared detection, high sensitivity, range 40 m Flat and compact sensor for high heights IP 65 Recommended fixing height: 15 m
0 489 21	<b>Special motion sensor for outdoor car parks and cellars</b> <b>Wall or ceiling mounted - surface mounting</b> Passive infrared detection with 270° adjustable head, range 20 m IP 55 Recommended fixing height: 2.5 m Can be fixed in a corner with a special accessory Cat. No 0 489 72

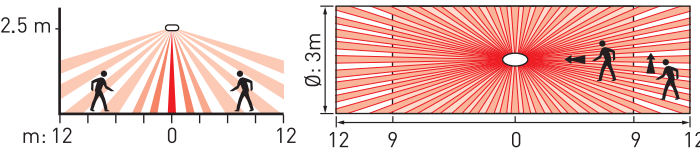
### Sensor coverage patterns

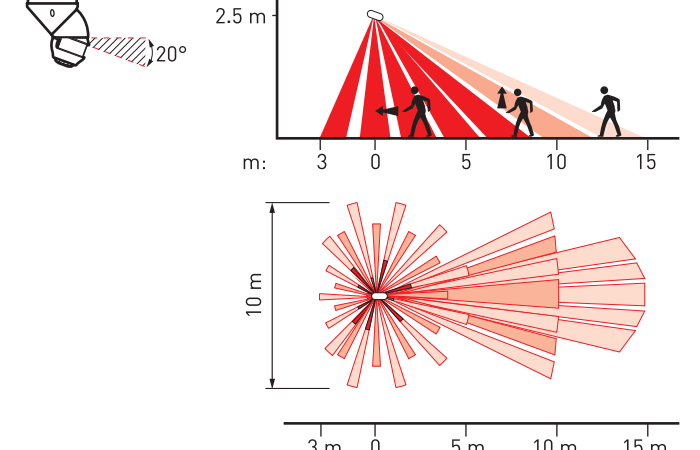
Cat. Nos	Installation technology type	Range	Detection area	Examples of applications
0 489 18		6 m (US) 5 m (PIR)		Classroom, meeting room, open plan office
0 489 22		8 m		Individual office, corridor, stairways, restrooms etc.
CP-EBDSPIR-KNX		7 m		Individual office, corridor, stairways, restrooms etc.

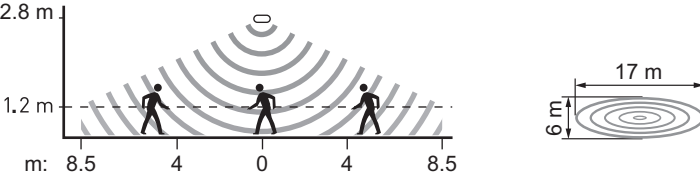
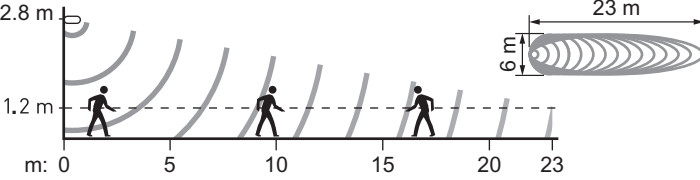
**Sensor coverage patterns**

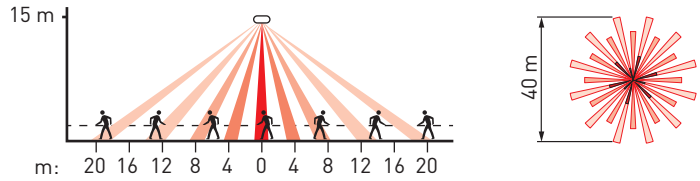
Cat. Nos	Installation technology type	Range	Detection area	Examples of applications
CP-MWS6-KNX		16 m		Individual office, corridor, stairways, restrooms etc.
0 489 19		2 x 12 m		Long corridor
0 489 21		18 m		High ceiling areas (warehouses, gymnasium) outdoor car park, basement, laboratory
CP-MWS3A-KNX		23 m	 	Long corridor
CP-EBDHS-KNX		40 m		High bay

# Living Now KNX

## KNX modular controllers



KNX certified



0 026 65

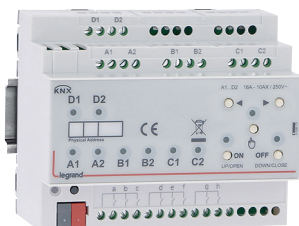

0 026 73

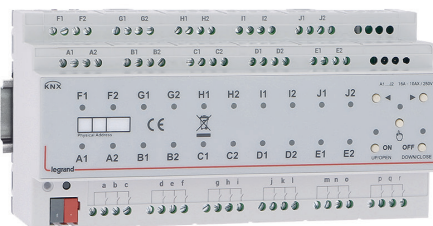

0 026 79



0 029 16

Connected with the KNX cable  
Configuration using ETS programming software

### Item **Modular controllers for dimming**

Each output can be controlled by a sensor and/or KNX control unit

#### For DALI control

0 026 65 1 output DALI bus (64 DALI ballasts max) to control up to 16 DALI groups and up to 64 DALI scenes  
4 DIN modules

0 026 99 1 output DALI bus (64 DALI ballasts max) to control individually up to 64 DALI luminaires and up to 16 DALI scenes  
4 DIN modules

#### 0 029 16 For DALI-2 control

1 channel DALI bus (64 DALI drivers max) to control up to 64 unicast commands and/or 16 group commands. Choice between KNX scenes or DALI scenes (16 max). DALI software allows modification of driver parameters (min/max/power/on value/fade, etc.). Each channel can be controlled by a detector and/or a BUS/KNX command color temperature control from the KNX BUS (<10 mA). 4 DIN modules

#### For 1-10V control

0 026 68 10 outputs 1-10 V also controlling 10 ON/OFF circuits (16 A max) 10 DIN modules

#### For LED and all other LV and ELV loads

0 026 54 2 outputs  
2 x 300 W/VA maximum per output  
4 DIN modules

### Modular ON/OFF controller

0 026 80 Each output can be controlled by a sensor and/or KNX control unit  
4 x 16 A outputs  
4 DIN modules

### Item **Modular multi-application ON/OFF controllers**

Each output can be controlled by a sensor and/or KNX control unit

Multi-application controllers with independent input channels and outputs configurable to control lighting loads, power sockets, roller shutters, and HVAC equipment

0 026 72 8 x 16 A outputs  
6 DIN modules

0 026 73 8 x 16 A outputs - 8 inputs  
6 DIN modules

0 026 74 12 x 16 A outputs  
6 DIN modules

0 026 76 16 x 16 A outputs  
10 DIN modules

0 026 78 20 x 16 A outputs  
10 DIN modules

0 026 79 20 x 16 A outputs - 18 inputs  
10 DIN modules

### Room Controller Unit

Power modules equipped with output contacts for controlling: - different types of ON/OFF load (lighting, roller shutters, contactors, motors, etc.)

- a DALI dimming output for 64 ballasts max.

Loads are managed by the controls to which they are linked: either by KNX controls, or by wired connection input terminals (switches, push-buttons, volt-free contacts)

Multiphase connection and consumption measurement

0 484 18 8 inputs - 10 outputs  
8 DIN modules

0 484 22 16 inputs - 16 outputs  
12 DIN modules

## Modular controllers - Load table at 230 V a.c. 50-60Hz

Cat.Nos	Outputs							
		Halogen lamp	ELV halogen lamp with ferromagnetic or electronic transformer	Fluorescent tube	LED and compact fluorescent lamp	Fluorescent lamp with 1-10 V ballast	DALI	Motors
<b>Modular controllers for dimming</b>								
0 026 65	1	-	-	-	-	-	64 ballasts (group control only)	-
0 026 99	1	-	-	-	-	-	64 ballasts (individual control)	-
0 029 16	1	-	-	-	-	-	64 drivers (individual and group control)	-
0 026 68	10	-	-	-	-	4000 VA	-	-
0 026 54	2	2 x 300 W	2 x 200 VA	2 x 300 VA	2 x 75 W	-	-	-
<b>Modular ON/OFF controllers</b>								
0 026 80	4	2 x 3680 W	4 x 1000 VA	4 x [10 x (2 x 36 W)]	4 x 500 VA	-	-	4 x 500 VA
0 026 72	8	8 x 4000 VA	8 x 1800 VA	8 x 2400 VA	8 x 400 VA	-	-	8 x 1000 VA
0 026 73	8	8 x 4000 VA	8 x 1800 VA	8 x 2400 VA	8 x 400 VA	-	-	8 x 1000 VA
0 026 74	12	12 x 4000 VA	12 x 1800 VA	12 x 2400 VA	12 x 400 VA	-	-	12 x 1000 VA
0 026 76	16	16 x 4000 VA	16 x 1800 VA	16 x 2400 VA	16 x 400 VA	-	-	16 x 1000 VA
0 026 78	20	20 x 4000 VA	20 x 1800 VA	20 x 2400 VA	20 x 400 VA	-	-	20 x 1000 VA
0 026 79	20	20 x 4000 VA	20 x 1800 VA	20 x 2400 VA	20 x 400 VA	-	-	20 x 1000 VA
<b>Room Controller Units</b>								
0 484 18	4	4 x 500 W	4 x 250 VA	4 x [2 x (2 x 36 W)]	4 x 80 VA	-	-	4 x 250 VA
	4	4 x 1000 W	4 x 500 VA	4 x [4 x (2 x 36 W)]	4 x 160 VA	-	-	4 x 500 VA
	2	2 x 3680 W	2 x 1000 VA	2 x [10 x (2 x 36 W)]	2 x 500 VA	-	1 x 64 ballasts	2 x 500 VA
0 484 22	4	4 x 500 W	4 x 250 VA	4 x [2 x (2 x 36 W)]	4 x 80 VA	-	-	4 x 250 VA
	8	8 x 1000 W	8 x 500 VA	8 x [4 x (2 x 36 W)]	8 x 160 VA	-	-	8 x 500 VA
	4	4 x 3680 W	4 x 1000 VA	4 x [10 x (2 x 36 W)]	4 x 500 VA	-	1 x 64 ballasts	4 x 500 VA

\*: Compatible with dimmable LED and compact fluorescent lamps



0 026 93



0 026 92



0 029 17

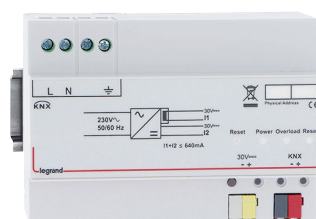

0 035 07

Connected with the KNX cable  
Configuration using ETS programming software

Item	<b>KNX interface - voltage contact</b>
0 026 93	Connects voltage free contacts devices (switches, push-buttons, alarms, etc.) to the KNX <b>Modular</b> 4 inputs 0 to 265 AC/DC powered 2 DIN modules
0 026 92	<b>Flush mounting</b> For installation in a flush-mounting box 4 inputs - 4 outputs
0 028 98	<b>Line coupler</b> Provides galvanic isolation between lines Necessary in an installation where there are more than 64 KNX participants 2 DIN modules
0 029 17	<b>IP/KNX router</b> Can act as main line or backbone coupler Links different KNX networks to each other via the IP infrastructure 2 DIN modules

Item	<b>Modular power supplies</b>
0 035 06	Powers one KNX line Integrated filter to prevent the short-circuit of BUS messages Voltage 230 V $\sim$ - 30 V $\equiv$ With additional 30 V unfiltered output 7 DIN modules 320 mA
0 035 07	640 mA
0 488 79	<b>KNX connector</b> Black and red Supplied in boxes of 50
0 492 91	<b>KNX cables</b> Length 500 m 0.8 mm dia. quad Isolation 4000 V 1 pair: red/black
0 492 92	2 pairs: red/black and yellow/white

## SECTION 5

# Cover plates range, boxes, supports and accessories





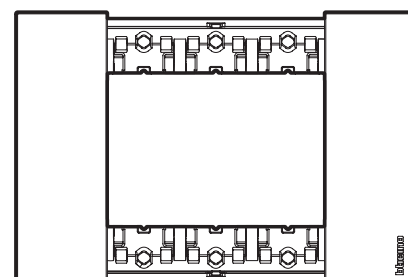
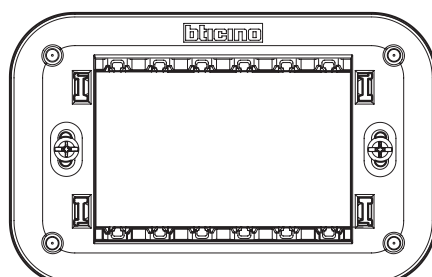
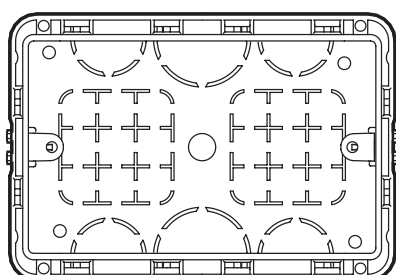





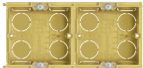
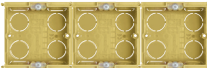
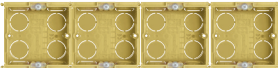





Essential installation elements for the physical, functional and aesthetic installation of Living Now.

## SECTION 5

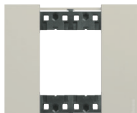
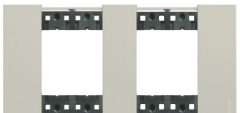
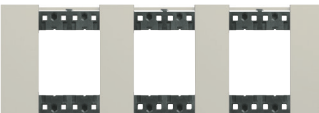
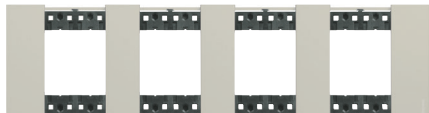

Type of system	Catalog section
Living Now standard system (Switches, sockets and cover plates for the residential electrical system)	1 + 5
Living Now with Netatmo (Connected controls for the smart home, which communicate via radio)	2 + 1 + 5
Living Now MyHOME (Advanced Smart Home controls, which communicate via SCS BTicino bus)	3 + 1 + 5
Living Now KNX (Connected controls for the smart home, which communicate via KNX standard bus)	4 + 1 + 5
<b>Living Now electrical system completion (cover plates range, boxes, accessories)</b>	<b>5</b>

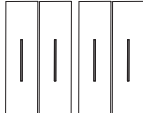
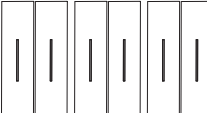
**SELECTION TABLE**

Flush mounted boxes	2 modules  502E (70x70x50 mm)	2+2 modules  502E (70x70x50 mm)	2+2+2 modules  502E (70x70x50 mm)	2+2+2+2 modules  502E (70x70x50 mm)
Plasterboard boxes	 PB502NN (Ø 71x50.5 mm)	 PB502NN (Ø 71x50.5 mm)	 PB502NN (Ø 71x50.5 mm)	 PB502NN (Ø 71x50.5 mm)
Supports	 K4702 (*)	 K4702 (*)	 K4702 (*)	 K4702 (*)
No. of function modules	 2 modules	 2+2 modules	 2+2+2 modules	 2+2+2+2 modules
Living Now cover plates	 KA4802...(**)	 KA4802M2...(**)	 KA4802M3...(**)	 KA4802M4...(**)
No. of 1-module covers required for the completion of the light point	 2 covers	 2+2 covers	 2+2+2 covers	 2+2+2+2 covers

**Note:** (\*) supplied without screws. Fastening using the screws supplied with boxes 502E and PB502NN.  
 (\*\*) both horizontal and vertical installation



- Note: protective shell supplied with supports, available in all modularities.

To be used:

- at the site, before the installation of cover plates and covers
- after removing cover plates and covers when painting the walls

**Living Now**  
installation examples

EXAMPLE OF INSTALLATION OF THE FUNCTIONS WITH 1-MODULE COVER

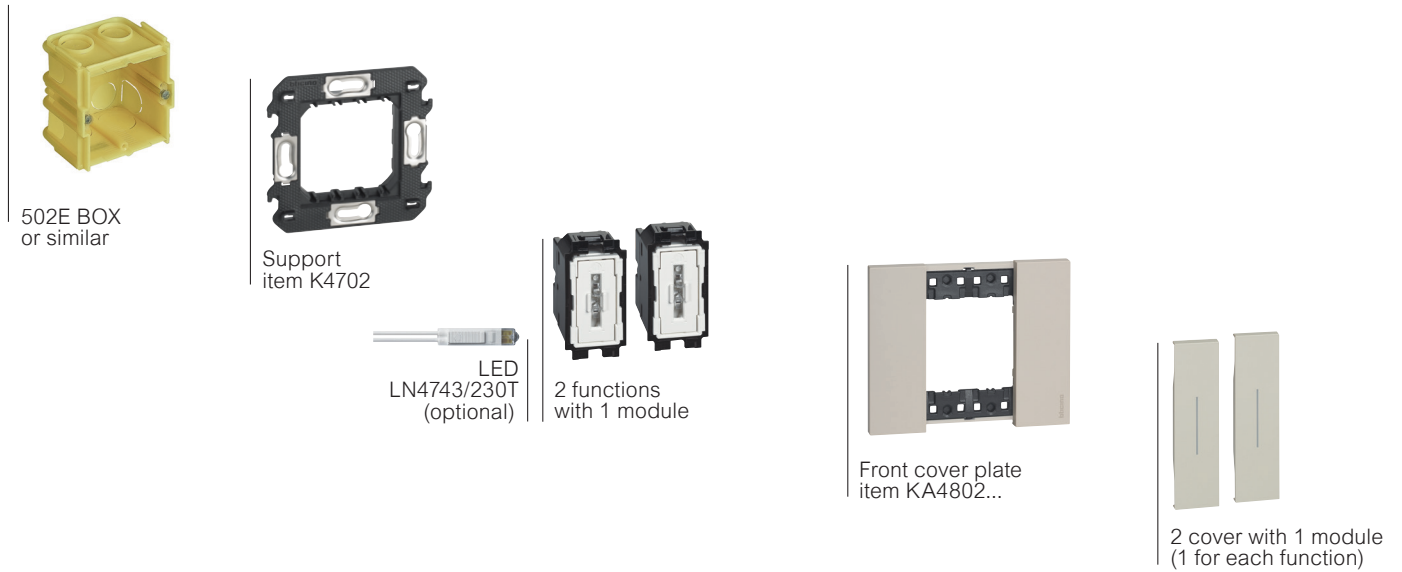

EXAMPLE OF FUNCTIONS COMPOSITION

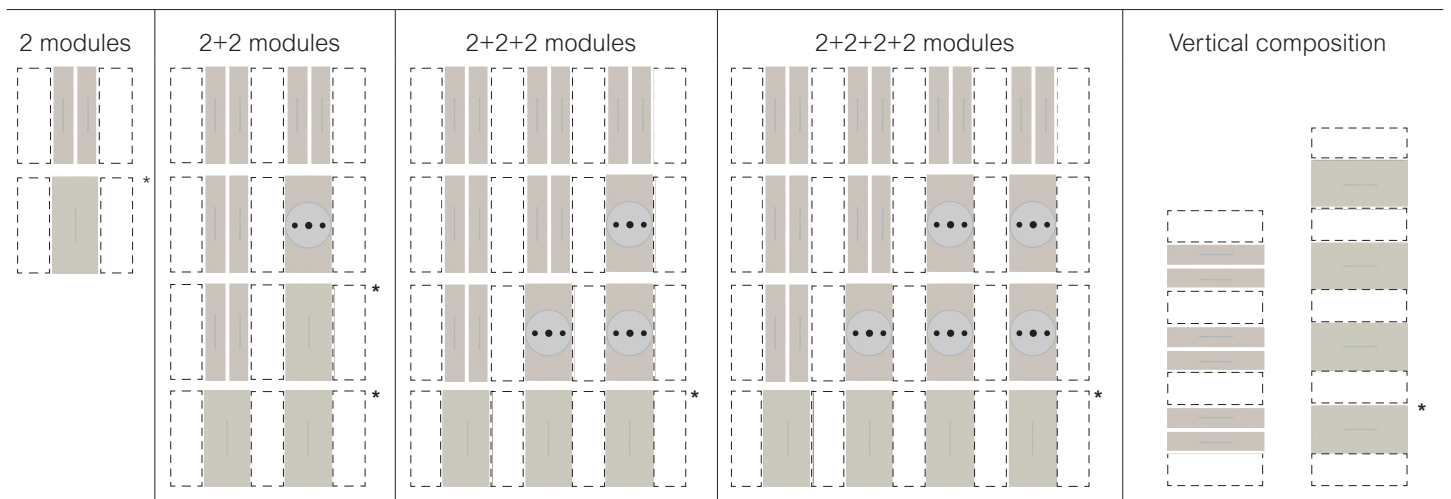

\* **Note:** for solutions using one 2-module cover for the main controls, it will be necessary to use two "half-module blanking modules" (item K4949) at the sides of the control. (see the sample diagrams below)

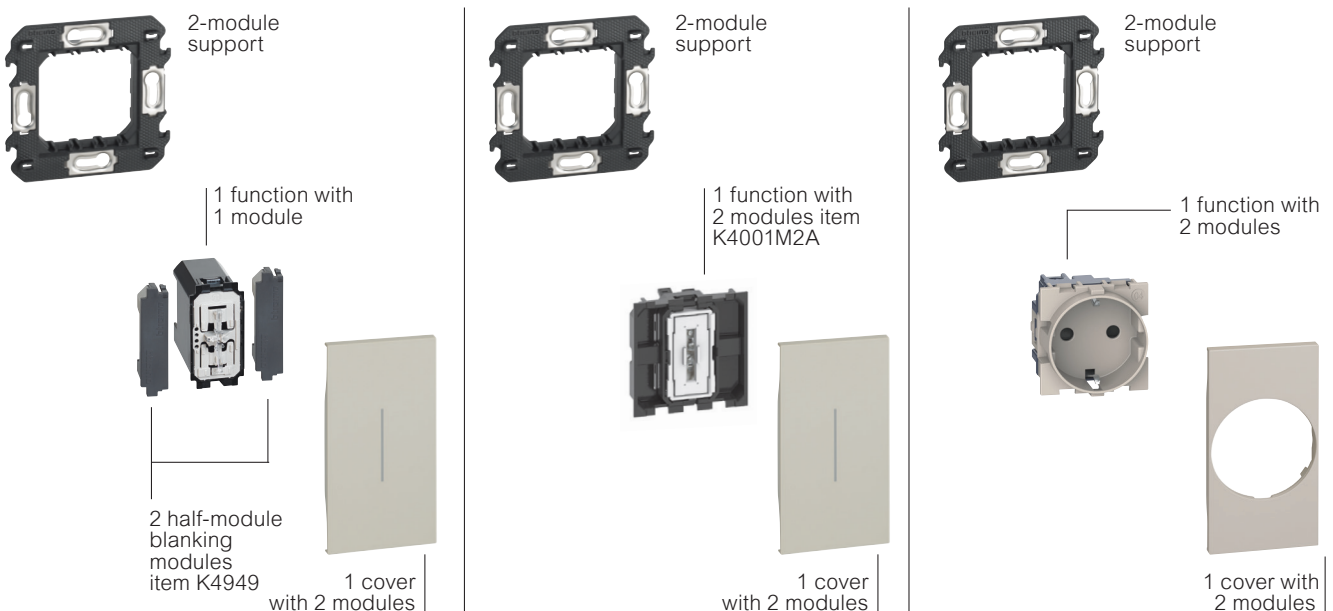

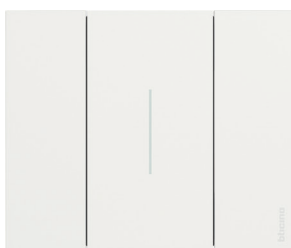
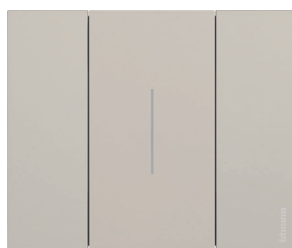
**COVER PLATES FOR MONOCHROMATIC SOLUTIONS****CHAMPAGNE - KC**  
(Material: zamak)**STEEL - KS**  
(Material: zamak)**BRONZE - KB**  
(Material: zamak)**WHITE - KW**  
(Material: technopolymer)**SAND - KM**  
(Material: technopolymer)**BLACK - KG**  
(Material: technopolymer)

**Note:** a perfect monochromatic effect is achieved by matching cover plates and devices in the same finish, as shown in the images.

**TECHNOPOLYMER COVER PLATES****ICE - DW**  
(Material: technopolymer)**NIGHT - DG**  
(Material: technopolymer)**ZAMAK COVER PLATES****GOLD - ZW**  
(Material: zamak)**MOON - NW**  
(Material: zamak)**COPPER - ZM**  
(Material: zamak)**SPACE - NG**  
(Material: zamak)**BRUSHED STEEL - ZG**  
(Material: zamak)

## WOOD COVER PLATES



OAK - LM  
(Material: wood)



WALNUT - LG  
(Material: wood)

### Notes:

- The cover plate/cover combinations shown in these pages are purely indicative. Each cover plate can in fact be combined with covers of any colours, as required by the customer (white, sand and black).
- The zamak and wood finishes are obtained using non-mass production procedures. The differences among the various cover plates are therefore a distinguishing valuable element.











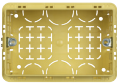

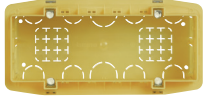

## SELECTION TABLE

Finish	2 modules		2+2 modules		2+2+2 modules		2+2+2+2 modules	
	KA4802KC	KA4802M2KC	KA4802M3KC	KA4802M4KC	KA4802KS	KA4802M2KS	KA4802M3KS	KA4802M4KS
CHAMPAGNE	KA4802KC	KA4802M2KC	KA4802M3KC	KA4802M4KC	KA4802KS	KA4802M2KS	KA4802M3KS	KA4802M4KS
STEEL	KA4802KB	KA4802M2KB	KA4802M3KB	KA4802M4KB	KA4802KW	KA4802M2KW	KA4802M3KW	KA4802M4KW
BRONZE	KA4802KM	KA4802M2KM	KA4802M3KM	KA4802M4KM	KA4802KG	KA4802M2KG	KA4802M3KG	KA4802M4KG
WHITE	KA4802DW	KA4802M2DW	KA4802M3DW	KA4802M4DW	KA4802DG	KA4802M2DG	KA4802M3DG	KA4802M4DG
SAND	KA4802ZW	KA4802M2ZW	KA4802M3ZW	KA4802M4ZW	KA4802NW	KA4802M2NW	KA4802M3NW	KA4802M4NW
BLACK	KA4802ZM	KA4802M2ZM	KA4802M3ZM	KA4802M4ZM	KA4802ZM	KA4802M2ZM	KA4802M3ZM	KA4802M4ZM
ICE	KA4802NG	KA4802M2NG	KA4802M3NG	KA4802M4NG	KA4802ZG	KA4802M2ZG	KA4802M3ZG	KA4802M4ZG
NIGHT	KA4802LM	KA4802M2LM	KA4802M3LM	KA4802M4LM	KA4802LG	KA4802M2LG	KA4802M3LG	KA4802M4LG
GOLD	KA4802LM	KA4802M2LM	KA4802M3LM	KA4802M4LM	KA4802LG	KA4802M2LG	KA4802M3LG	KA4802M4LG
MOON	KA4802LM	KA4802M2LM	KA4802M3LM	KA4802M4LM	KA4802LG	KA4802M2LG	KA4802M3LG	KA4802M4LG
COPPER	KA4802LM	KA4802M2LM	KA4802M3LM	KA4802M4LM	KA4802LG	KA4802M2LG	KA4802M3LG	KA4802M4LG
SPACE	KA4802LM	KA4802M2LM	KA4802M3LM	KA4802M4LM	KA4802LG	KA4802M2LG	KA4802M3LG	KA4802M4LG
BRUSHED STEEL	KA4802LM	KA4802M2LM	KA4802M3LM	KA4802M4LM	KA4802LG	KA4802M2LG	KA4802M3LG	KA4802M4LG
OAK	KA4802LM	KA4802M2LM	KA4802M3LM	KA4802M4LM	KA4802LG	KA4802M2LG	KA4802M3LG	KA4802M4LG
WALNUT	KA4802LM	KA4802M2LM	KA4802M3LM	KA4802M4LM	KA4802LG	KA4802M2LG	KA4802M3LG	KA4802M4LG

### Supports

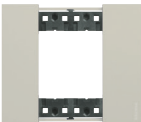
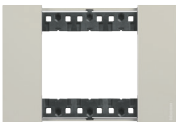
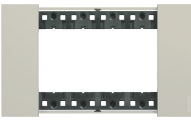
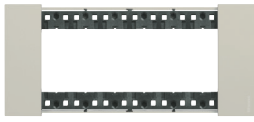
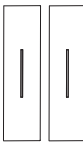
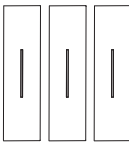
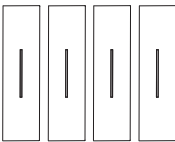
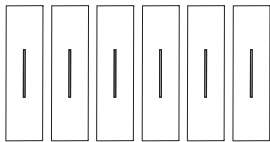

SELECTION TABLE

	2 modules	3 modules	4 modules	6 modules
Flush mounted boxes	 502E (70x70x50 mm)	 503E (108x74x53.5 mm)	 504E (133x74x53.5 mm)	 506L (183.5x90x53.5 mm)
Plasterboard boxes	 PB502NN (Ø 71x50.5 mm)	 PB503NN (110x71x52 mm)	 PB504NN (132.5x71x52 mm)	 PB506NN (183x71x52 mm)
Supports	 K4702 (*)	 K4703 with screws	 K4704 with screw	 K4706 with screw
No. of function modules	 2 modules	 3 modules	 4 modules	 6 modules
Living Now cover plates	 KA4802...	 KA4803...	 KA4804...	 KA4806...
No. of 1-module covers required for the completion of the light point	 2 covers	 3 covers	 4 covers	 6 covers

\* **Note:** supplied without screws. Fastening using the screws supplied with boxes 502E and PB502NN.

PROTECTED INSTALLATIONS

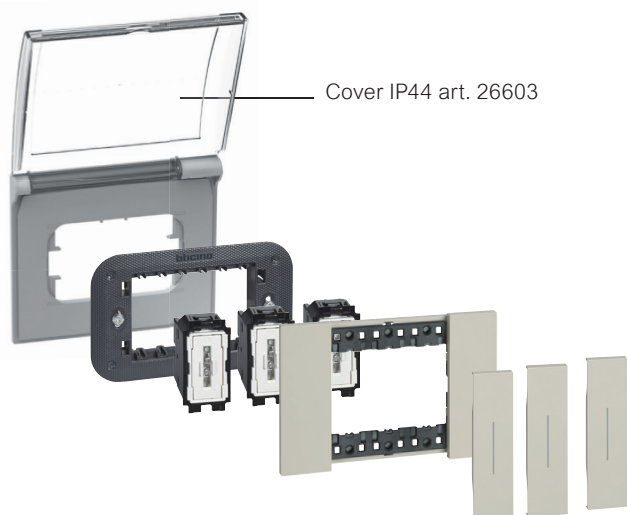

- Note: protective shell supplied with supports, available in all modularities.

To be used:

- at the site, before the installation of cover plates and covers
- after removing cover plates and covers when painting the walls

**Living Now**  
installation examples

EXAMPLE OF INSTALLATION OF THE FUNCTIONS WITH 1-MODULE COVER

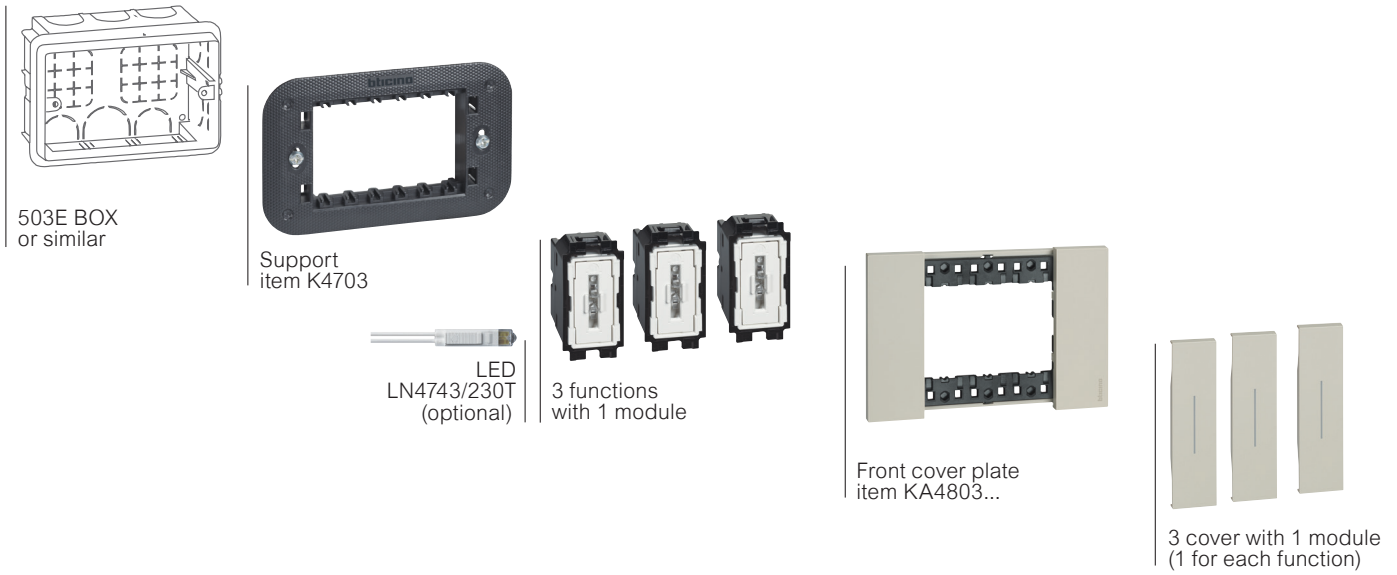

EXAMPLE OF FUNCTIONS COMPOSITION

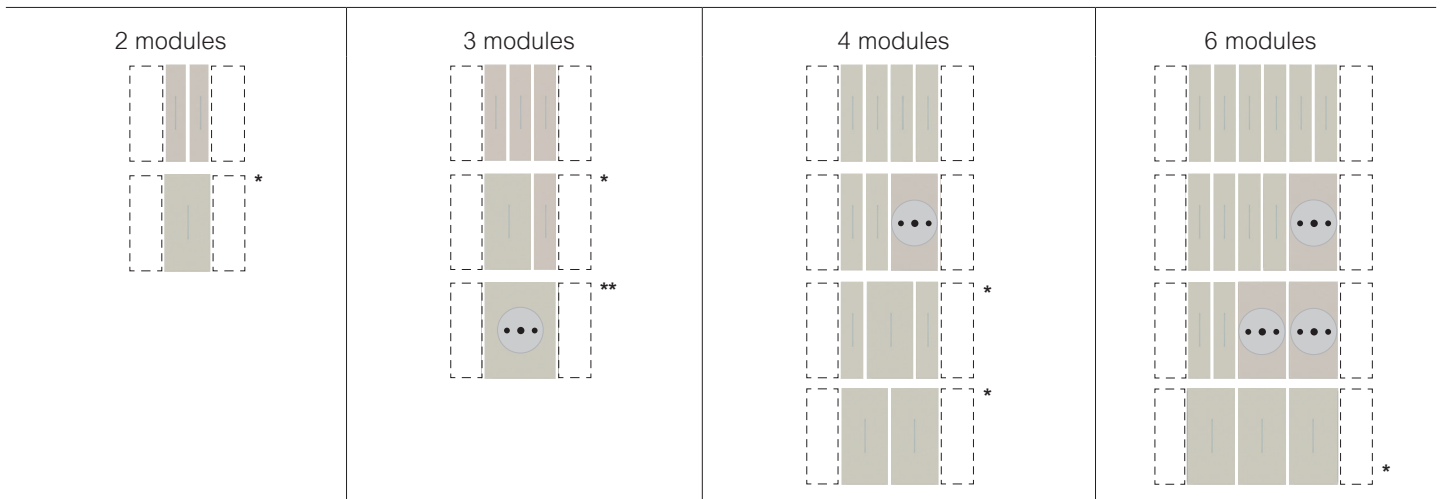

\* **Note:** for solutions using one 2-module cover for the main controls, it will be necessary to use two "half-module blanking modules" (item K4949) at the sides of the control. (see the sample diagrams below)

\*\* German standard socket centred on 3-module light point

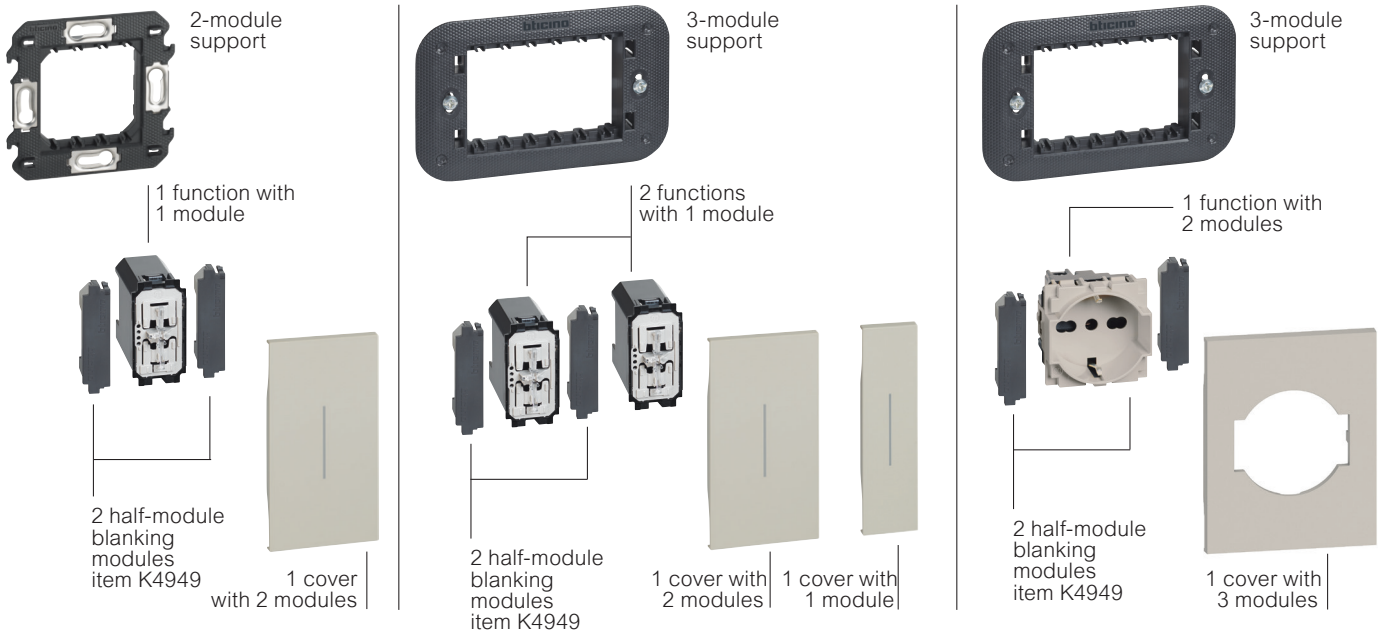

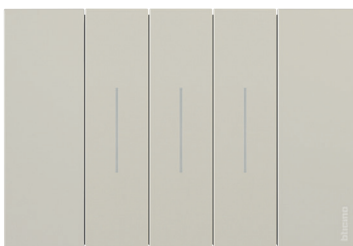
**COVER PLATES FOR MONOCHROMATIC SOLUTIONS****CHAMPAGNE - KC**  
(Material: zamak)**STEEL - KS**  
(Material: zamak)**BRONZE - KB**  
(Material: zamak)**WHITE - KW**  
(Material: technopolymer)**SAND - KM**  
(Material: technopolymer)**BLACK - KG**  
(Material: technopolymer)

**Note:** a perfect monochromatic effect is achieved by matching cover plates and devices in the same finish, as shown in the images.

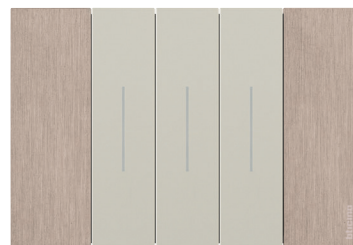
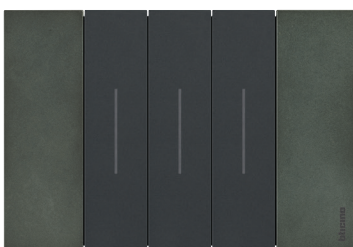
**TECHNOPOLYMER COVER PLATES****ICE - DW**  
(Material: technopolymer)**NIGHT - DG**  
(Material: technopolymer)**ZAMAK COVER PLATES****GOLD - ZW**  
(Material: zamak)**MOON - NW**  
(Material: zamak)**COPPER - ZM**  
(Material: zamak)**SPACE - NG**  
(Material: zamak)**BRUSHED STEEL - ZG**  
(Material: zamak)

## WOOD COVER PLATES



OAK - LM  
(Material: wood)

























WALNUT - LG  
(Material: wood)













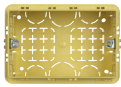





### Notes:

- The cover plate/cover combinations shown in these pages are purely indicative. Each cover plate can in fact be combined with covers of any colours, as required by the customer (white, sand and black).
- The zamak and wood finishes are obtained using non-mass production procedures. The differences among the various cover plates are therefore a distinguishing valuable element.

## SELECTION TABLE

Finish				
	2 modules	3 modules	4 modules	6 modules
 CHAMPAGNE	KA4802KC	KA4803KC	KA4804KC	KA4806KC
 STEEL	KA4802KS	KA4803KS	KA4804KS	KA4806KS
 BRONZE	KA4802KB	KA4803KB	KA4804KB	KA4806KB
 WHITE	KA4802KW	KA4803KW	KA4804KW	KA4806KW
 SAND	KA4802KM	KA4803KM	KA4804KM	KA4806KM
 BLACK	KA4802KG	KA4803KG	KA4804KG	KA4806KG
 ICE	KA4802DW	KA4803DW	KA4804DW	KA4806DW
 NIGHT	KA4802DG	KA4803DG	KA4804DG	KA4806DG
 GOLD	KA4802ZW	KA4803ZW	KA4804ZW	KA4806ZW
 MOON	KA4802NW	KA4803NW	KA4804NW	KA4806NW
 COPPER	KA4802ZM	KA4803ZM	KA4804ZM	KA4806ZM
 SPACE	KA4802NG	KA4803NG	KA4804NG	KA4806NG
 BRUSHED STEEL	KA4802ZG	KA4803ZG	KA4804ZG	KA4806ZG
 OAK	KA4802LM	KA4803LM	KA4804LM	KA4806LM
 WALNUT	KA4802LG	KA4803LG	KA4804LG	KA4806LG
Supports	 K4702	 K4703	 K4704	 K4706

**SELECTION TABLE**

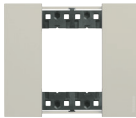
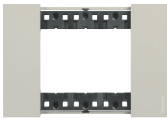
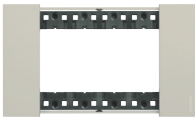
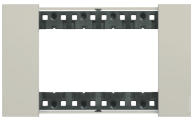
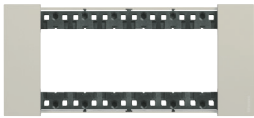
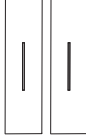
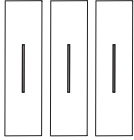
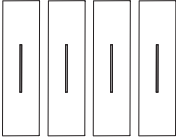
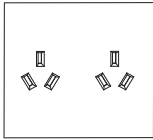
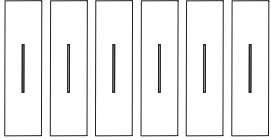
	2 modules	3 modules	4 modules	4 modules socket K4134 (to be used with 3 module boxes only)	6 modules
Flush mounted boxes	 502E (70x70x50 mm)	 503E (108x74x53.5 mm)	 504E (133x74x53.5 mm)	 503E (108x74x53.5 mm)	 506L (183.5x90x53.5 mm)
Plasterboard boxes	 PB502NN (Ø 71x50.5 mm)	 PB503NN (110x71x52 mm)	 PB504NN (132.5x71x52 mm)	 PB503NN (110x71x52 mm)	 PB506NN (183x71x52 mm)
Supports (screw fixing only)	 K4702 (*)	 K4703AU with screws	 K4704 with screw	 Provided with socket	 K4706 with screw
No. of function modules	 2 modules	 3 modules	 4 modules	 4 modules	 6 modules
Living Now cover plates	 KA4802...	 KA4803...	 KA4804...	 KA4814...	 KA4806...
No. of 1-module covers required to complete the switches	 2 covers	 3 covers	 4 covers	 specific covers	 6 covers

\* **Note:** supplied without screws. Fastening using the screws supplied with boxes 502E and PB502NN.

# Living Now

## installation examples

### EXAMPLE OF INSTALLATION OF THE FUNCTIONS WITH 1-MODULE COVER

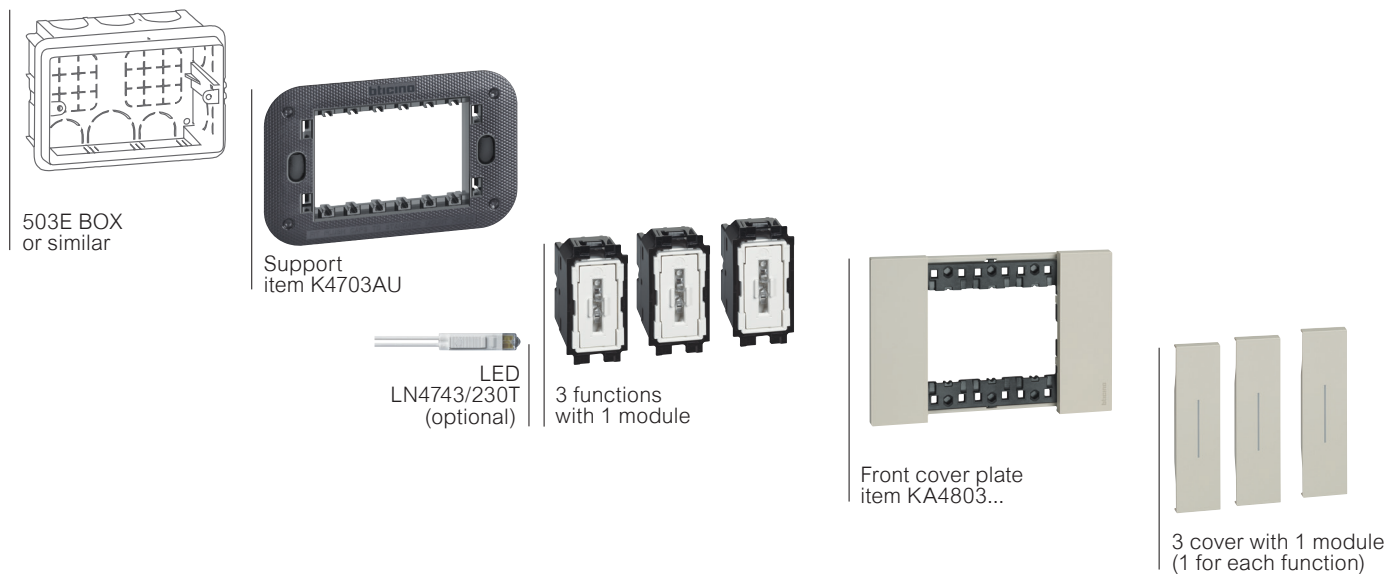

### EXAMPLE OF FUNCTIONS COMPOSITION

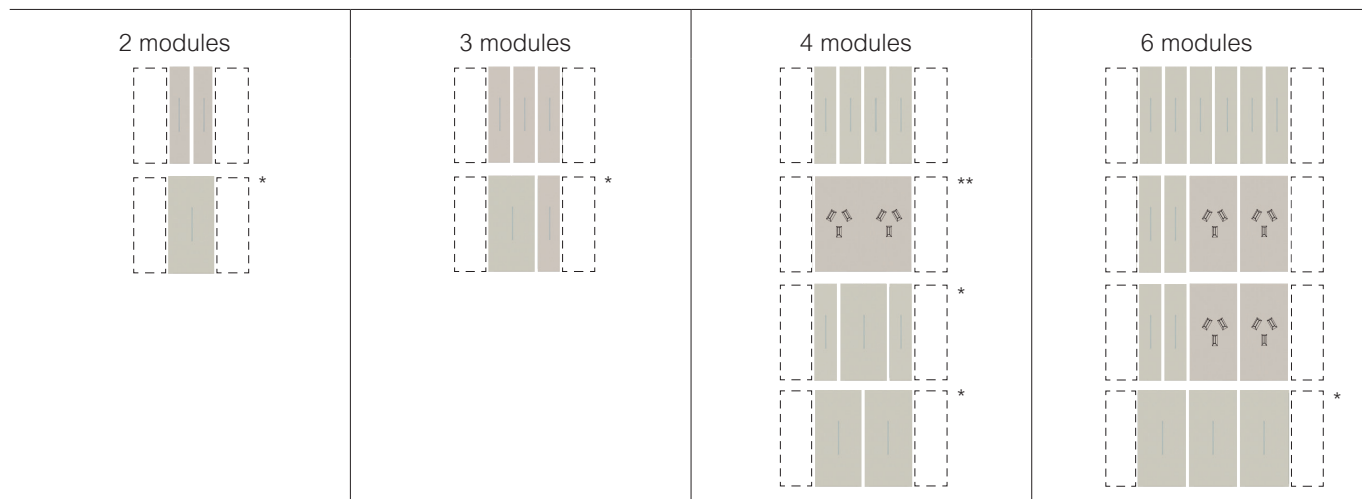

\* **Note:** for solutions using one 2-module cover for the main controls, it will be necessary to use two “half-module blanking modules” (item K4949) at the sides of the control. (see the sample diagrams below)

\*\* monoblock installed on a three module box

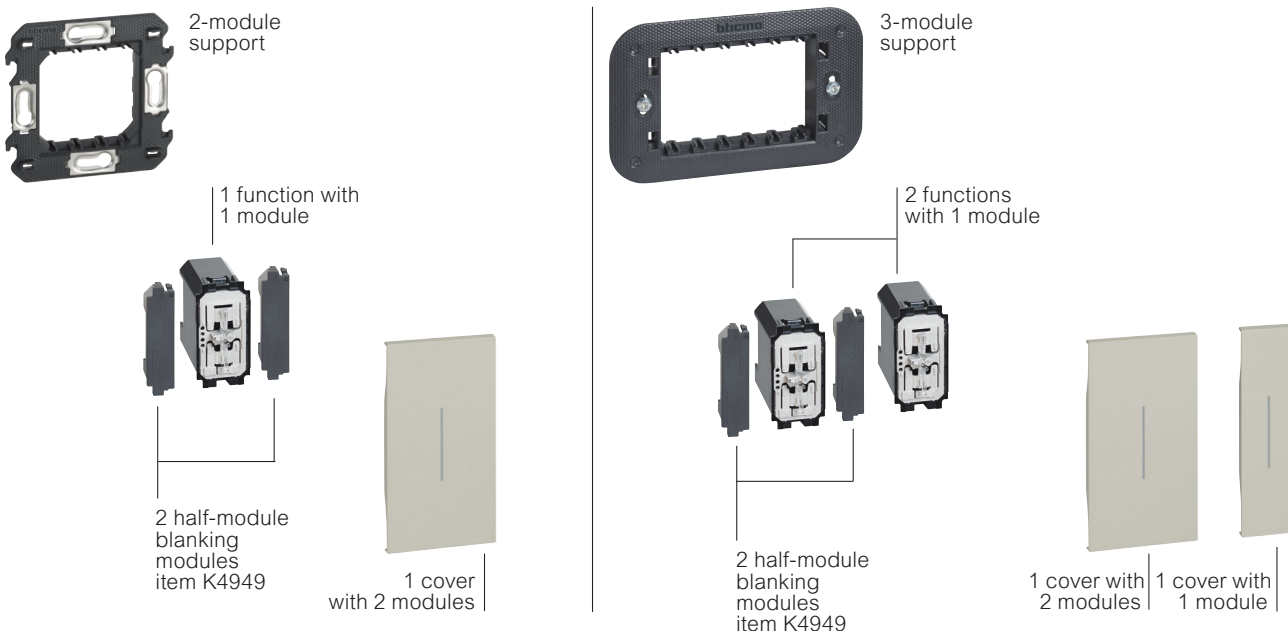

**COVER PLATES FOR MONOCHROMATIC SOLUTIONS****CHAMPAGNE - KC**  
(Material: zamak)**STEEL - KS**  
(Material: zamak)**BRONZE - KB**  
(Material: zamak)**WHITE - KW**  
(Material: technopolymer)**BLACK - KG**  
(Material: technopolymer)

**Note:** a perfect monochromatic effect is achieved by matching cover plates and devices in the same finish, as shown in the images.

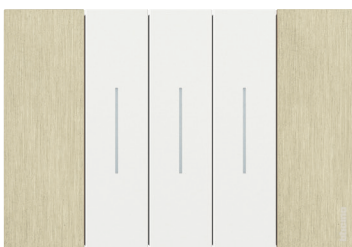
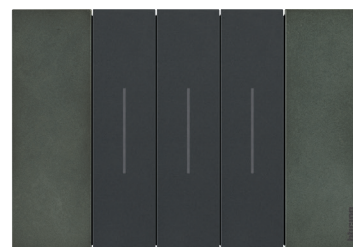
**TECHNOPOLYMER COVER PLATES****ICE - DW**  
(Material: technopolymer)**NIGHT - DG**  
(Material: technopolymer)**ZAMAK COVER PLATES****GOLD - ZW**  
(Material: zamak)**MOON - NW**  
(Material: zamak)**SPACE - NG**  
(Material: zamak)**BRUSHED STEEL - ZG**  
(Material: zamak)

## WOOD COVER PLATES







WALNUT - LG  
(Material: wood)

### Notes:













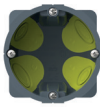









- The cover plate/cover combinations shown in these pages are purely indicative. Each cover plate can in fact be combined with covers of any colours, as required by the customer (white, sand and black).
- The zamak and wood finishes are obtained using non-mass production procedures. The differences among the various cover plates are therefore a distinguishing valuable element.

## SELECTION TABLE

Finish	 2 modules		 3 modules		 4 modules		 specific covers		 6 modules	
	 <b>CHAMPAGNE</b>	KA4802KC	KA4803KC	KA4804KC	KA4814KC	KA4806KC				
 <b>STEEL</b>	KA4802KS	KA4803KS	KA4804KS	KA4814KS	KA4806KS					
 <b>BRONZE</b>	KA4802KB	KA4803KB	KA4804KB	KA4814KB	KA4806KB					
 <b>WHITE</b>	KA4802KW	KA4803KW	KA4804KW	KA4814KW	KA4806KW					
 <b>BLACK</b>	KA4802KG	KA4803KG	KA4804KG	KA48104KG	KA4806KG					
 <b>ICE</b>	KA4802DW	KA4803DW	KA4804DW	KA4814DW	KA4806DW					
 <b>NIGHT</b>	KA4802DG	KA4803DG	KA4804DG	KA4814DG	KA4806DG					
 <b>GOLD</b>	KA4802ZW	KA4803ZW	KA4804ZW	KA4814ZW	KA4806ZW					
 <b>MOON</b>	KA4802NW	KA4803NW	KA4804NW	KA4814NW	KA4806NW					
 <b>SPACE</b>	KA4802NG	KA4803NG	KA4804NG	KA4814NG	KA4806NG					
 <b>BRUSHED STEEL</b>	KA4802ZG	KA4803ZG	KA4804ZG	KA4814ZG	KA4806ZG					
 <b>WALNUT</b>	KA4802LG	KA4803LG	KA4804LG	KA4814LG	KA4806LG					
<b>Supports</b>	 K4702	 K4703AU	 K4704	 Provided with socket	 K4706					

**COMPOSITION OF DIGITAL CONTROLS**

For each type of box, the electrified frames used and the number of devices and the accessories that can be installed are indicated.

	2 modules	3 modules	4 modules		
Flush mounted boxes	 502E (70x70x50 mm)	 503E (108x74x53.5 mm)	 504E (133x74x53.5 mm)		
Plasterboard boxes	 PB502NN (ø 71x50,5 mm)	 PB503NN (110x71x52 mm)	 PB504NN (132.5x71x52 mm)		
Supports	 K8102	 K4703 with screws	 K4704 with screws		
Flush mounted boxes - connection module K8001; - actuators K8002L and e K8002S; - additional power supply K8003 (2 modules).	*  3 modules		*  4 modules		
Blanking module K4950	 max. 2 blanking modules		 max. 3 blanking modules		
Electrified frame	 3 modules ..8102P1	 3 modules ..8103	 3+1 modules ..8103P1	 4 modules ..8104	 4+1 modules ..8104P1
Voice control item ..8013 (3 modules) Digital control Light item ..8010 and Full item ..8011 Cover for blanking module item 4950					

**WARNING FOR THE SELECTION OF THE DEVICES:**

- Note (\*)** The connection module is necessary; its position is free inside the box.
- If the installation of the additional power supply, item K8003, is required for the voice command, item ....8013 (see the MyHOME guide for the details), connection module item K8001 must not be installed. The additional power supply (space required 2 modules) can only be installed in the electrified frame or together with 1 or 2 actuators, depending on the size of the box.

# Living Now

## installation examples

### INSTALLATION EXAMPLE OF THE DIGITAL CONTROLS

#### Installation with flush-mounted actuator

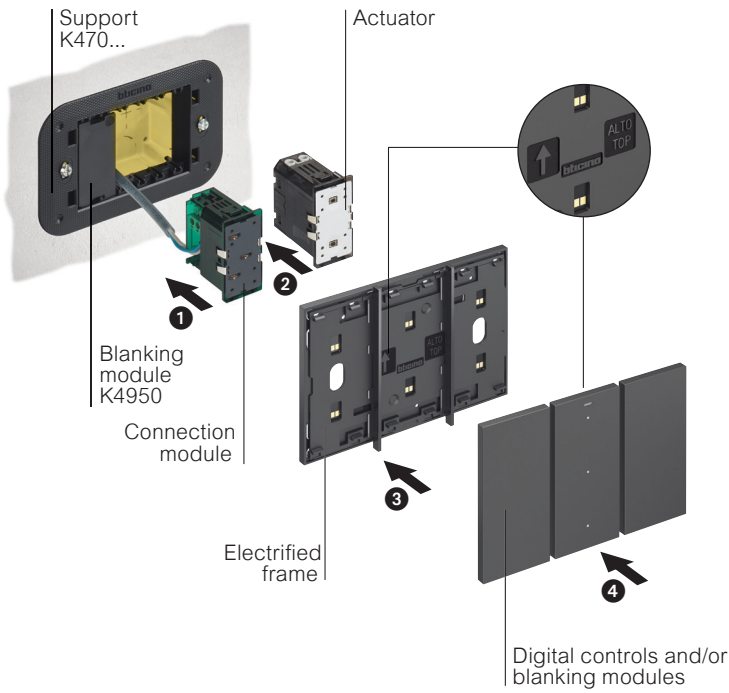

Use in conjunction with the connection module, or another actuator, to take up the power voltage.

#### Installation with actuator in DIN switchboard

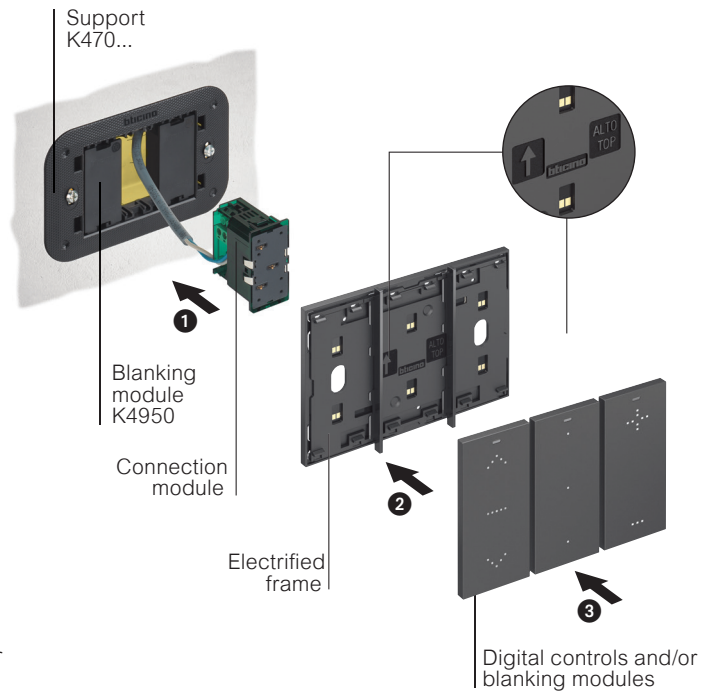

At the side of the connection module, install 2 false poles, item K4950, in any position.

#### Installation of the voice control

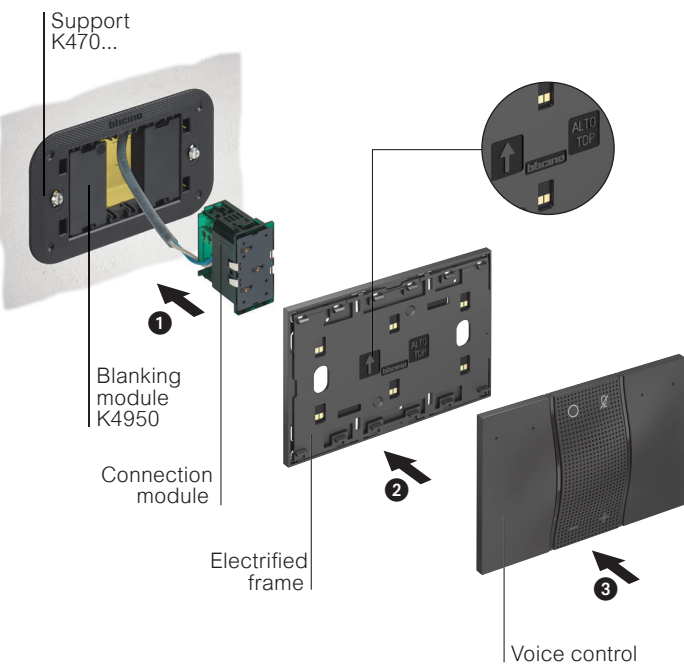







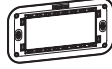

Remove the finishing bars from the electrified frame. When installing power supply item K8003, connection module item K8001 must not be used.

# Living Now standard electrical system

## support frames and IP44 housing



Item	Supports
K4702	 2-module support frame supplied with protective shell
K4703	 3-module support frame supplied with protective shell
K4703AU	 3-module support frame Australia
K4704	 4-module support frame supplied with protective shell
K4706	 6-module support frame supplied with protective shell
500/00	 Pair of 35 mm screws for the fastening of the supports to boxes installed below the plaster work.
K8102	 Support for the installation of the electrified frame item KW8102P1, KG8102P1, KM8102P1 in 2 module box
KA4902	 Accessorie for 2 module support frame - to be used on Indian standard installations

Item	IP44 housing
26603	 IP44 protection cover (guaranteed when closed). Ideal for installation where an IP44 protection degree is required. Fully compatible with all ranges, both BTicino and other brands. It is made with high-quality material which guarantees long-term sealing against all weather conditions. It can be installed on Italian standard 3-module flush mounted box
503CG	Protective cover for flush mounted box item 503E - to be used during finishing masonry works
503EV	Internal resin separator - for box item 503E - for the separation of data and power circuits
503EC	Finishing cover for flush mounted box item 503E - to be used when the box is used as a junction box - can be painted
504EC	Cover as above, for boxes item 504E
506EC	Cover as above, for boxes item 506E
503DE	Internal resin separator - for box item 504E
503ED	Coupling for boxes items 502E, 503E, 504E (horizontal and vertical) and for box 506L (only vertical). It cannot be used with the box extension

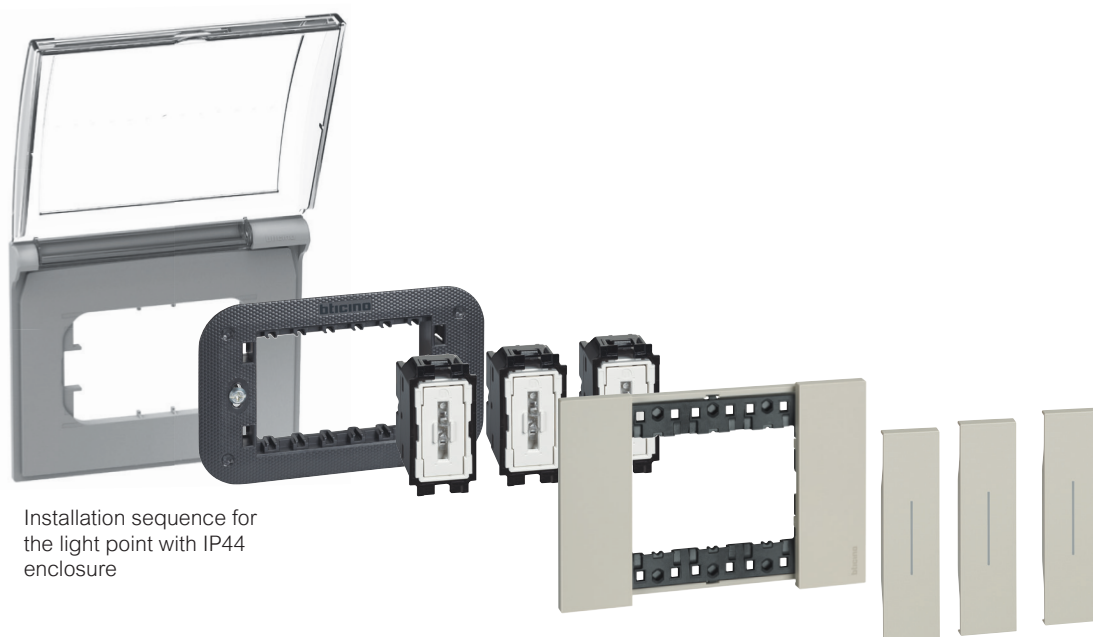

Installation sequence for the light point with IP44 enclosure

# Living Now

## how to install the covers

### INSTALLATION

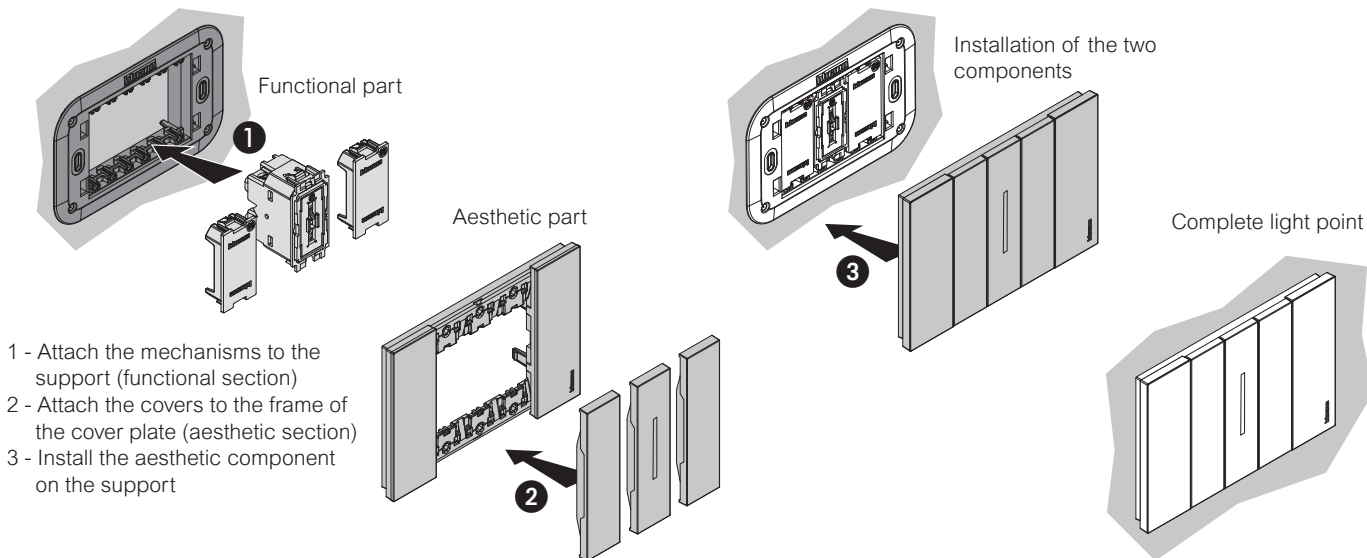

### REMOVING MOBILE COVERS

Mobile covers are those that move in relation to the light point, to allow the activation of a control (traditional, connected or MyHOME)

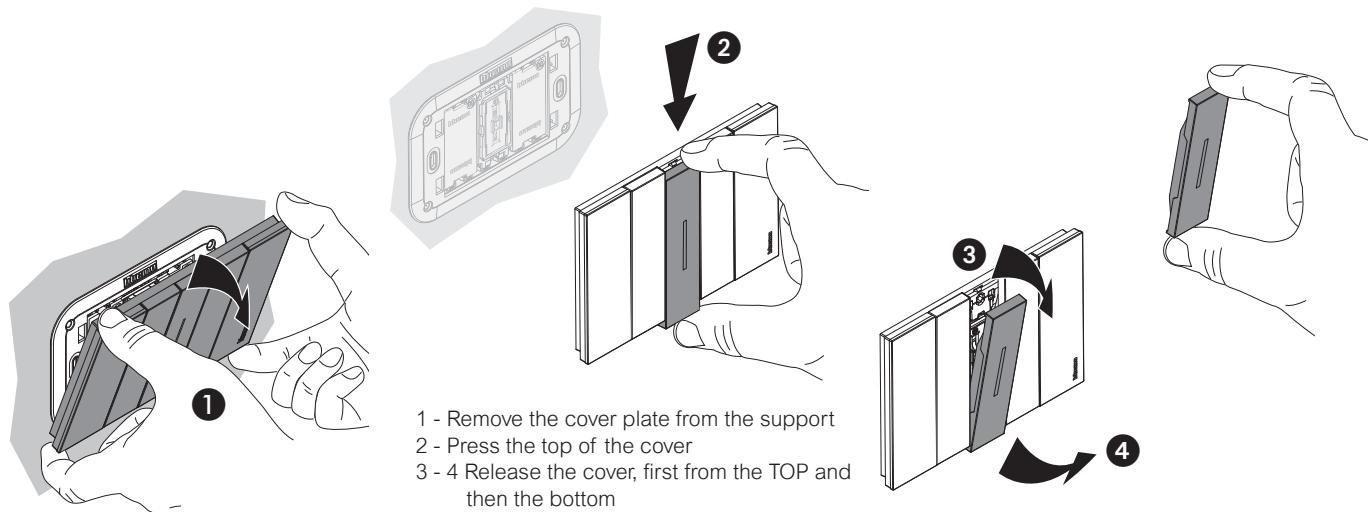





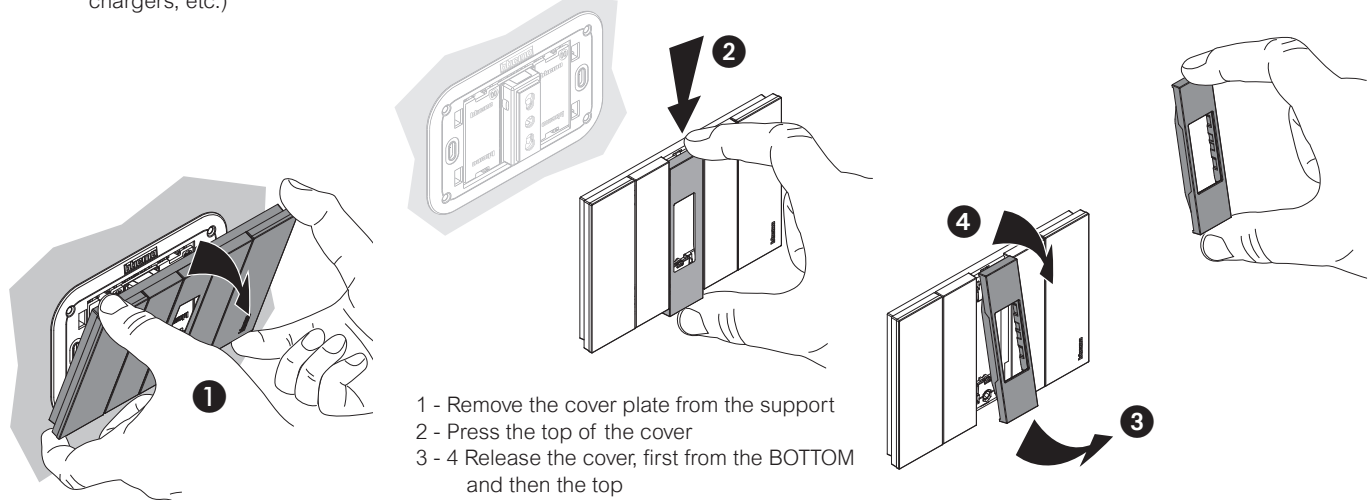

### REMOVING FIXED COVERS

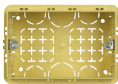
Fixed covers those are attached to the cover plates, such as for example blanking modules and all non-control devices (e.g. sockets, RJ connectors, TV sockets, USB chargers, etc.)

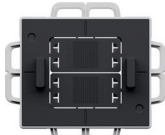
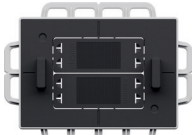
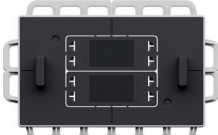
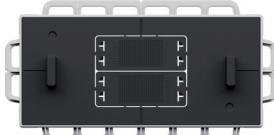

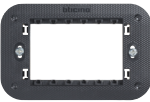







**INSTALLATION FOR MASONRY WALLS**

Flush mounted boxes	2 modules  <b>502E</b> (70x70x50 mm)	3 modules  <b>503E</b> (108x74x53.5 mm)	4 modules  <b>504E</b> (133x74x53.5 mm)	6 modules  <b>506L</b> (183.5x90x53.5 mm)
Accessories for full flush installation	 <b>502EF</b>	 <b>503EF</b>	 <b>504EF</b>	 <b>506EF</b>
Supports	 <b>K4702</b> (*)	 <b>K4703</b> with screws	 <b>K4704</b> with screws	 <b>K4706</b> with screws

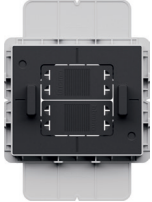
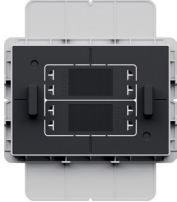
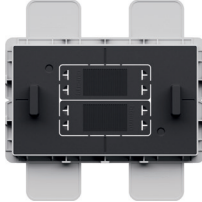
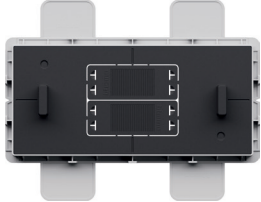
**Note:** (\*) supplied without screws. Fastening using the screws supplied with boxes 502E and PB502NN.

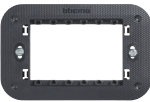
**INSTALLATION FOR PLASTERBOARD WALLS**

Flush mounted boxes	2 modules  <b>PB502NN</b> (ø 71x50,5 mm)	3 modules  <b>PB503NN</b> (110x71x52 mm)	4 modules  <b>PB504NN</b> (132.5x71x52 mm)	6 modules  <b>PB506NN</b> (183x71x52 mm)
Accessories for full flush installation	 <b>PB502NNF</b>	 <b>PB503NNF</b>	 <b>PB504NNF</b>	 <b>PB506NNF</b>
Supports	 <b>K4702</b> (*)	 <b>K4703</b> with screws	 <b>K4704</b> with screws	 <b>K4706</b> with screws

**Note:** (\*) supplied without screws. Fastening using the screws supplied with boxes 502E and PB502NN.

# Living Now

## InWall installation - technical elements

### ACCESSORY FOR MASONRY WALLS

The accessory adjustment system on the flush-mounting box allows for alignment recovery with the wall surface, even when the box is improperly positioned.

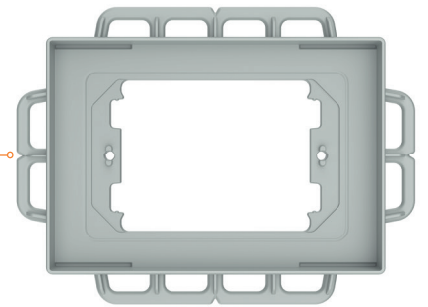
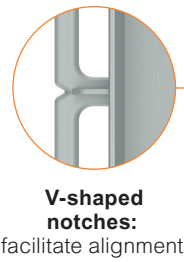
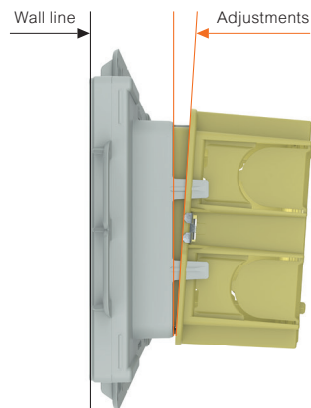

**Rings around the entire perimeter:** covered with concrete during installation, they ensure secure fastening without the appearance of cracks.

### ACCESSORY FOR PLASTERBOARD WALLS

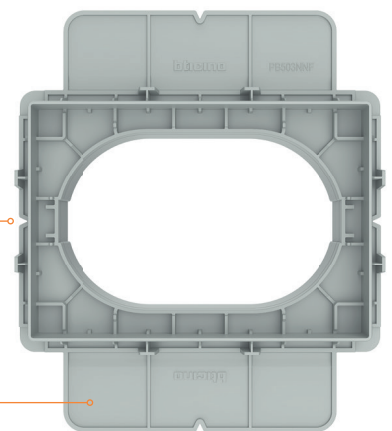
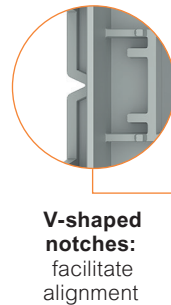
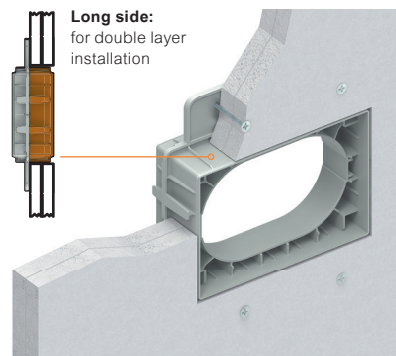
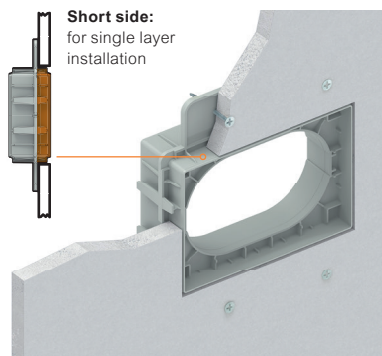

The accessory can be installed on both single-layer and double-layer drywall, depending on the side resting against the board. By screwing the fixing tabs to the board, a secure and permanent anchoring is achieved.

### PROTECTIVE COVER: COMMON TO MASONRY AND PLASTERBOARD WALLS

Common to both accessories (masonry/plasterboard), it has two handles (1 and 2) that provide convenient support for a spirit level for optimal positioning of the switches and facilitate its removal at the end of the work.

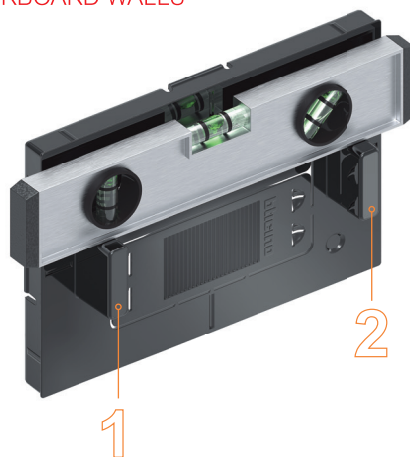



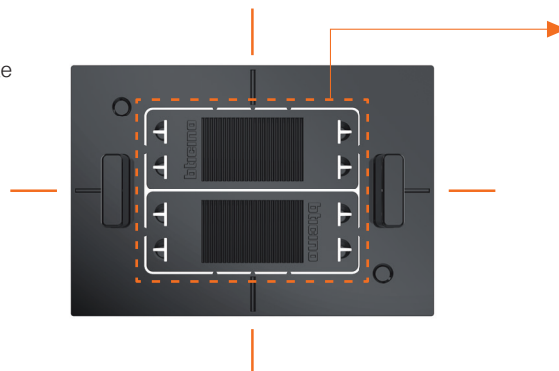



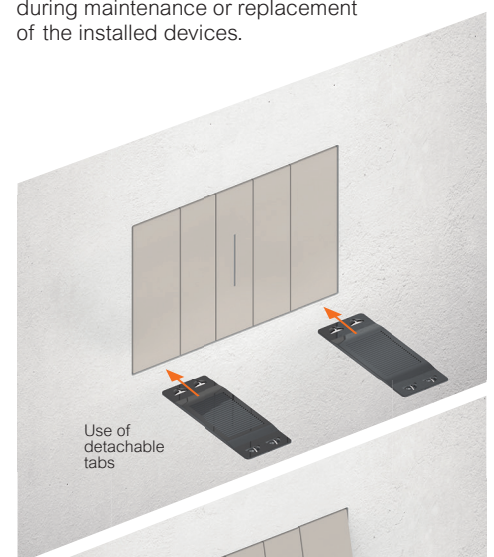

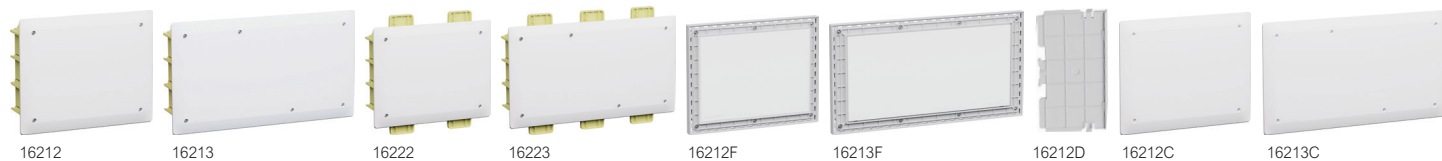

The markings on the centre lines facilitate the positioning of the accessory.



The accessory surface features two detachable tabs, used to remove the cover plate from the support during maintenance or replacement of the installed devices.



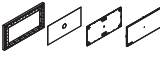

Item	Junction boxes	Item	Accessories for junction boxes
○ 16212	 Flush-mounted junction box for masonry walls, complete with paintable cover - made of shock-resistant polystyrene Internal dimensions 193x149x82 (mm) External dimensions 209x165x93 (mm)	○ 16212D	 Internal divider for compartmentalisation. For boxes art. 16212 - 16213 - 16222 - 16223
○ 16213	 Flush-mounted junction box for masonry walls, complete with paintable cover - made of shock-resistant polystyrene Internal dimensions 284x149x82 (mm) External dimensions 300x165x93 (mm)	○ 16212C	 Replacement cover, paintable surface. For boxes art. 16212 - 16222
○ 16222	 Junction box for plasterboard walls complete with paintable cover - in self-extinguishing PC+ABS blend. Internal dimensions 193x149x82 (mm) External dimensions 209x217x93 (mm)	○ 16213C	 Replacement cover, paintable surface. For boxes art. 16213 - 16223
○ 16223	 Junction box for plasterboard walls complete with paintable cover - in self-extinguishing PC+ABS blend. Internal dimensions 284x149x82 (mm) External dimensions 300x217x93 (mm)	○ 16100GO	 Pair of couplings for horizontal coupling of two or more boxes.
<b>Kit for flush-mounted installation</b>			
○ 16212F	 Wall installation kit for boxes measuring 193x149x82 (mm) art. 16212 - 16222, complete with frame, technical cover, aesthetic cover		
○ 16213F	 Wall installation kit for boxes measuring 284x149x82 (mm) item no. 16213 - 16223, complete with frame, technical cover, aesthetic cover		

## Living Now

### InWall installation - new junction boxes technical elements

#### INWALL JUNCTION BOXES: DESIGNED DOWN TO THE SMALLEST DETAIL TO SIMPLIFY INSTALLATION

The new full flush junction boxes have been designed with extreme attention to detail and enhanced with accessories and innovative technological solutions, designed to simplify the work of installers as much as possible.

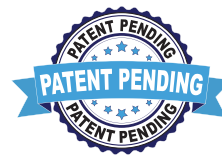

#### Boxes for plasterboard walls

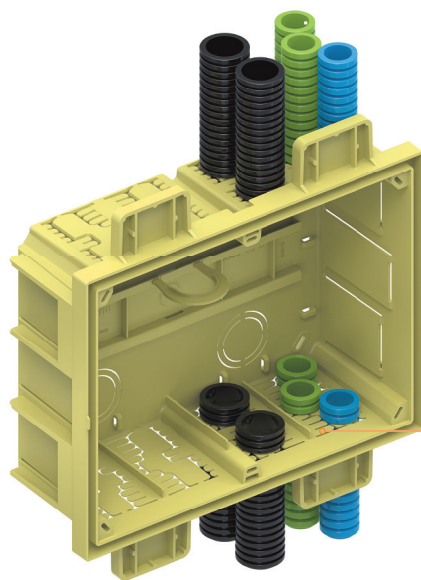

#### COMB-SHAPED ENTRIES FOR CORRUGATED CONDUIT RETENTION

On the long sides, there are pre-fabricated sections with comb-shaped retaining tabs, designed as entry points for corrugated conduits. Once used, these entries securely hold the conduit, preventing it from slipping behind the wall.

**Each slot can accommodate either three 20mm corrugated conduits or two 25mm ones.**

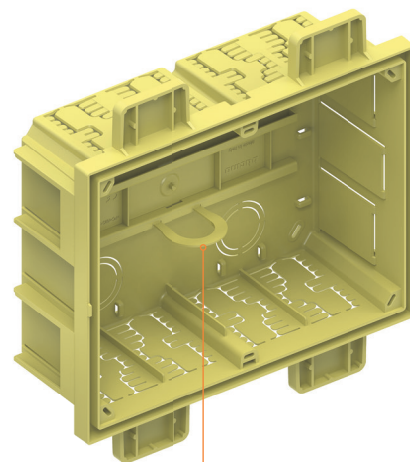

#### RETAINING RING FOR FIXING

The boxes are equipped with a ring that serves to hold the box in place during the fixing operation. Once this operation is complete, the ring can be removed.

#### Boxes for plasterboard and masonry walls

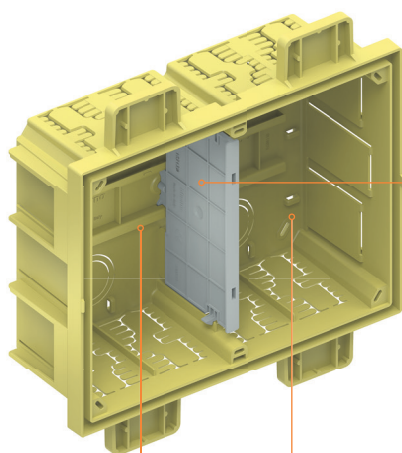

#### INTERNAL DIVIDER

To divide and isolate the different circuits inside the same electrical box, ensuring safety and order (item 16212D).

#### COUPLINGS FOR HORIZONTAL COUPLING

Useful for joining two boxes together: item 16100GO

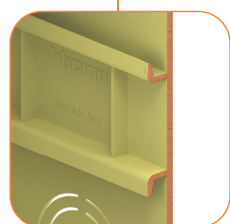
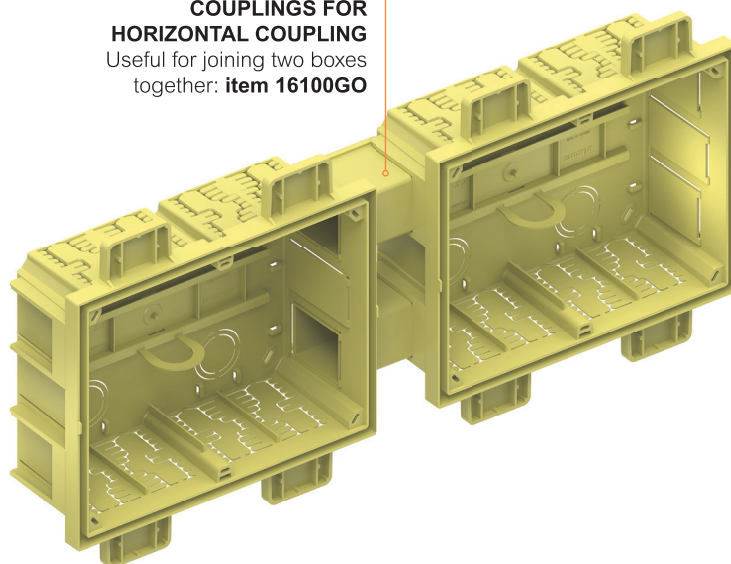

#### DIN RAIL

Located on the bottom of the box.

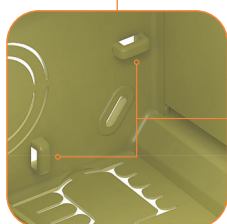

#### CABLE TIE ANCHORING LOOPS

They ensure stable and tidy fastening of cables and corrugated conduits.

**Note:** the boxes shown in the images are for plasterboard walls. The instructions are also valid for boxes for masonry walls.

**Living Now cover plates (3 module area system)**

2-module cover plate

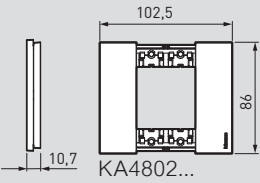

3-module cover plate

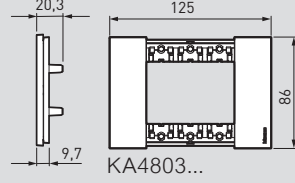

4-module cover plate

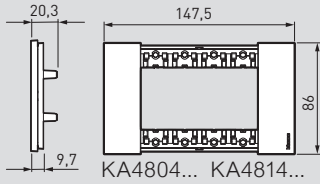

6-module cover plate

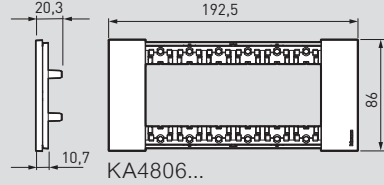

**Living Now cover plates (2 module area system)**

2-module cover plate

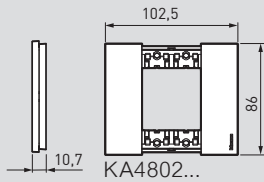

2+2-module cover plate

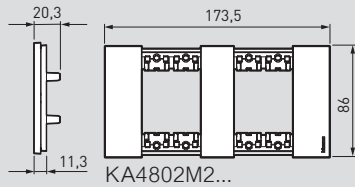

2+2+2-module cover plate

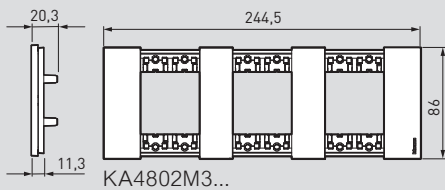

2+2+2+2-module cover plate

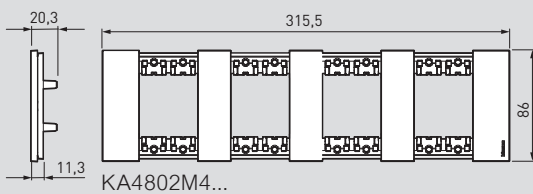

**Living Now supports (3 module area system)**

2-module support

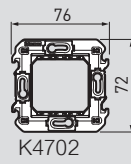

3-module support

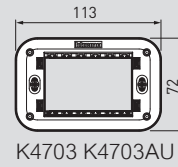

4-module support

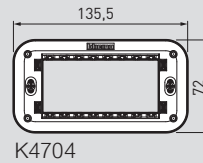

6-module support

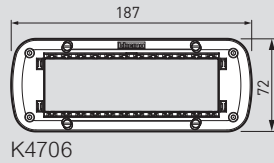

**Living Now support (2 module area system)**

2-module support

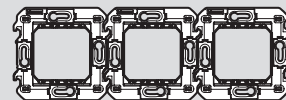
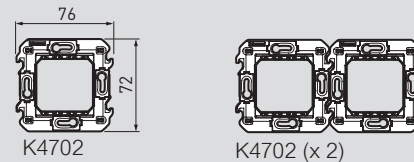

K4702 (x 3)

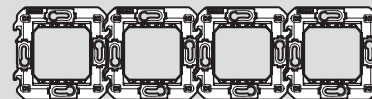

K4702 (x 4)

# Living Now

## dimensional data

### ■ Living Now MyHOME electrified frames

3-module electrified frame

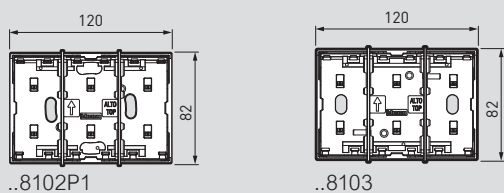

3+1-module electrified frame, 4 module

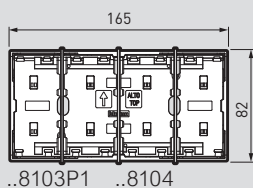

4+1-module electrified frame

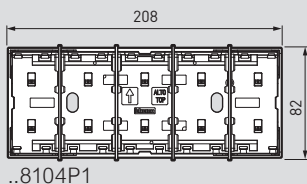

2-module support

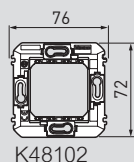

3-module support

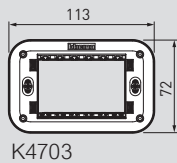

4-module support

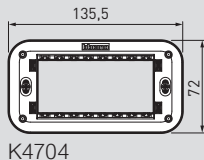

### ■ Smarter with Netatmo

flush mounted installation

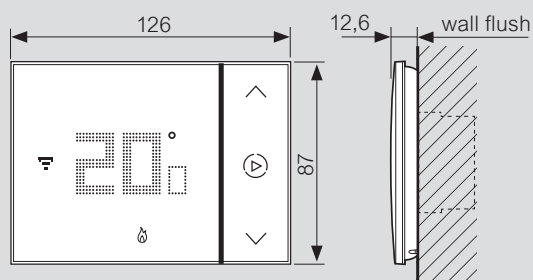

XW8002 - XM8002 - XG8002

plasterboard installation

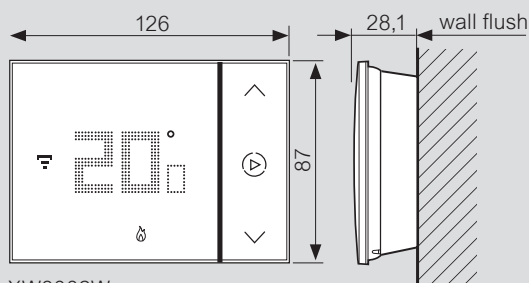

XW8002W

■ **Accessories for InWall installation**

**For masonry wall**

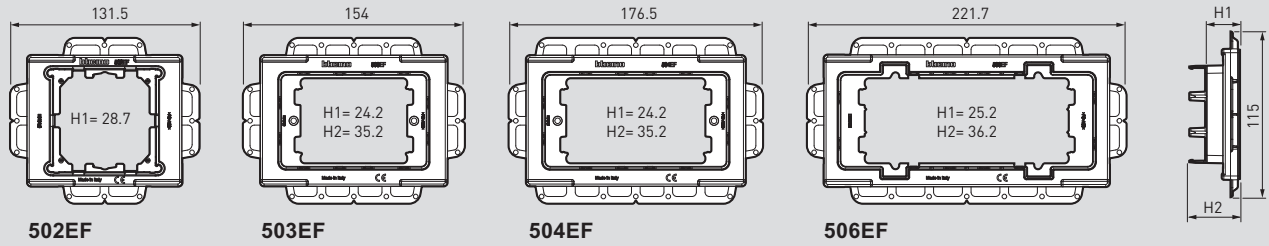

**For plasterboard wall**

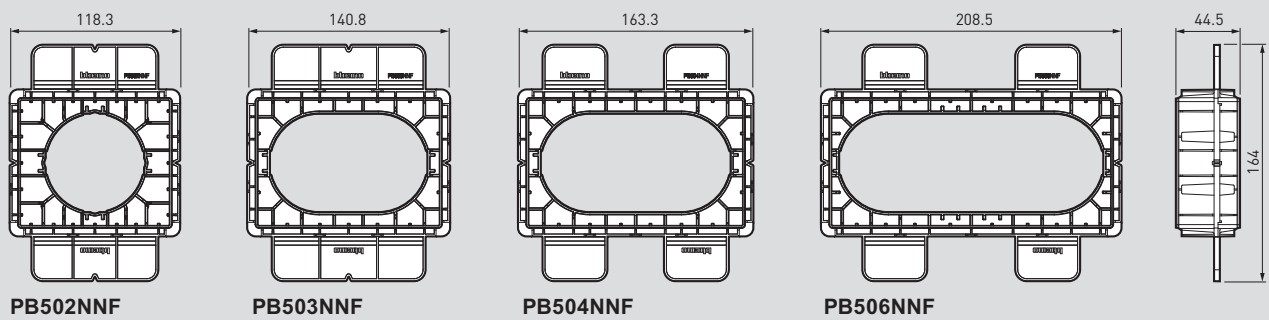

■ **Junction boxes - also for InWall installation**

**For masonry wall**

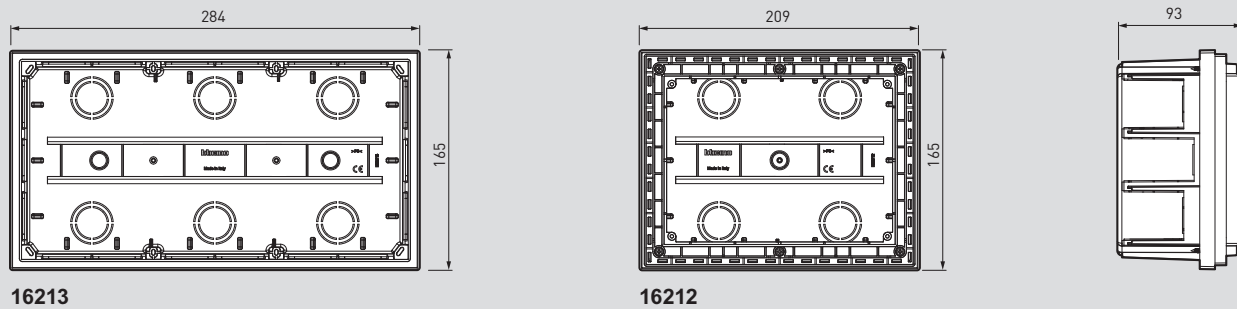

**For plasterboard wall**

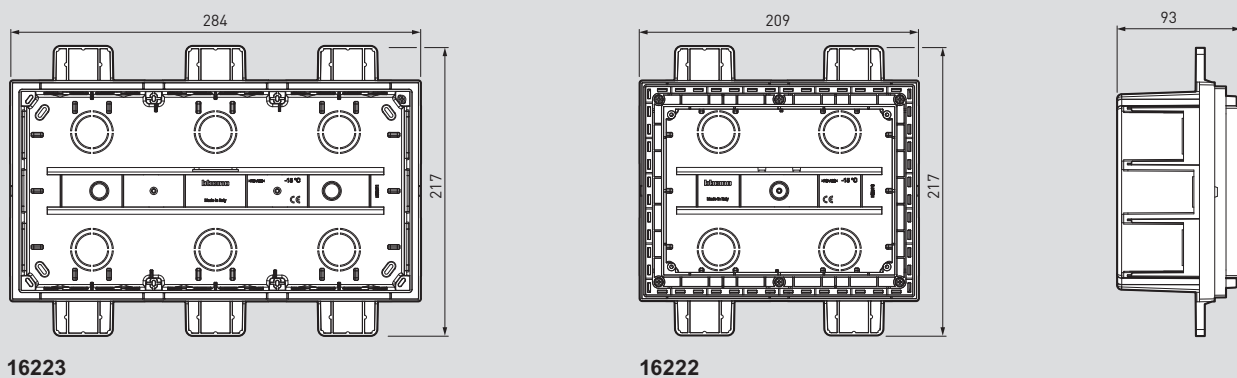



**BTicino SpA**  
Viale Borri, 231  
21100 Varese - Italy  
[www.bticino.com](http://www.bticino.com)

AD-EXLW26C/GB - Edition 05/2026