



AUDIO & VIDEO DOOR ENTRY SYSTEMS



KITS AND SYSTEM SOLUTIONS FOR SINGLE HOUSES, BUILDINGS AND COMPOUNDS



#ImprovingLives

Index

Offer overview

Different solutions for different applications	4
--	---

EASYKIT

EASY KITS (two wires)	6
-----------------------------	---

BASIC KITS

BASIC KITS (four wires)	26
-------------------------------	----

PROFESSIONAL KITS

Features overview	31
Villa CONNECTED VIDEO KITS (two wires)	35
Villa VIDEO KITS (two wires)	40
Villa AUDIO KITS (two wires)	42
Villa ANALOGUE AUDIO KITS	44

2 WIRES SYSTEM

System overview	46
Entrance panels range	50
Internal units range	94
System accessories range	124

IP SYSTEM

System overview	130
Entrance panels range	140
Internal units range	142
Guard station and accessories range	146

Different solutions for different applications

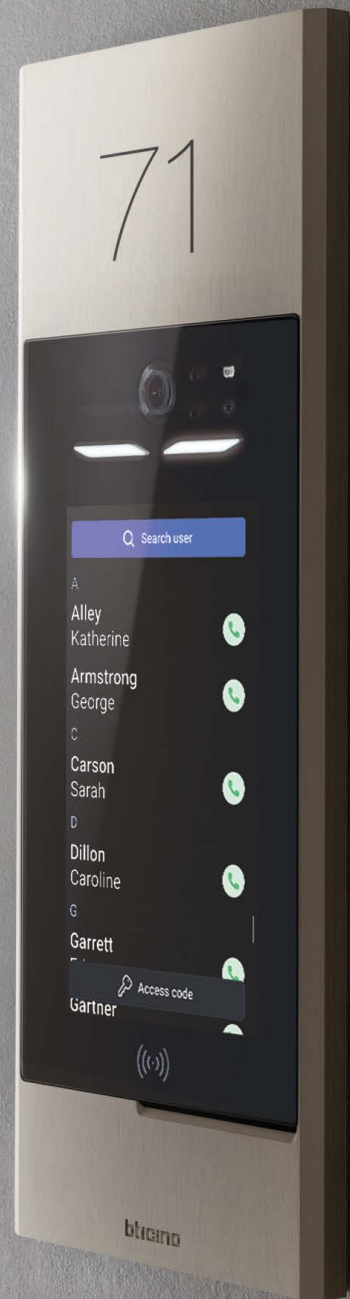

From villas to multi-family units



Villas



Small building



Building complex

Different types of constructions
mean different types of offer

EASYKIT - BASIC KITS

for standard level villas



Closed solution that provides **BASIC FUNCTIONS**, normally for simple systems:



- one or two family homes
- ready made solutions
- expandable solutions
- plug-in or DIN power supply

PROFESSIONAL KITS

for high level villas



Initial basic solution that **CAN DEVELOP** into a **MORE COMPLEX** and **CUSTOMISED** systems:



- one or two-family homes
- ready made solutions
- fully expandables
- enhanced functions

2 WIRES SYSTEM

for small buildings

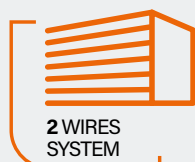

The best technology when **TIME SAVING** and **EASE** of **INSTALLATION** are required:

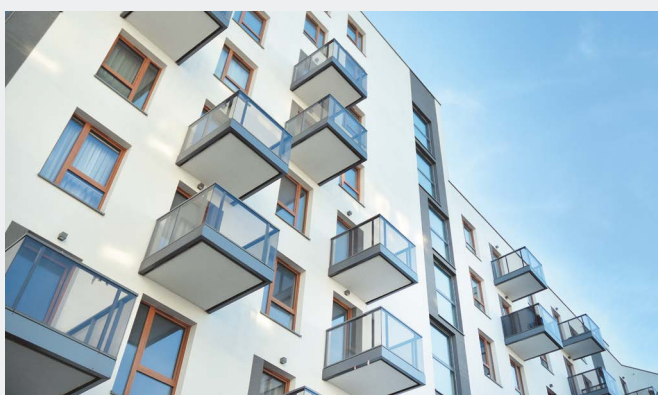

- small buildings/homes
- easy and quick to install
- maximum versatility
- perfect for refurbishments

IP SYSTEM

for building complex



The system conceived for **BIG RESIDENTIAL BUILDINGS** where IP cabling is required.



- larger buildings and complexes
- high performances
- long distances and high number of apartments
- integrated security functions

EASYKIT

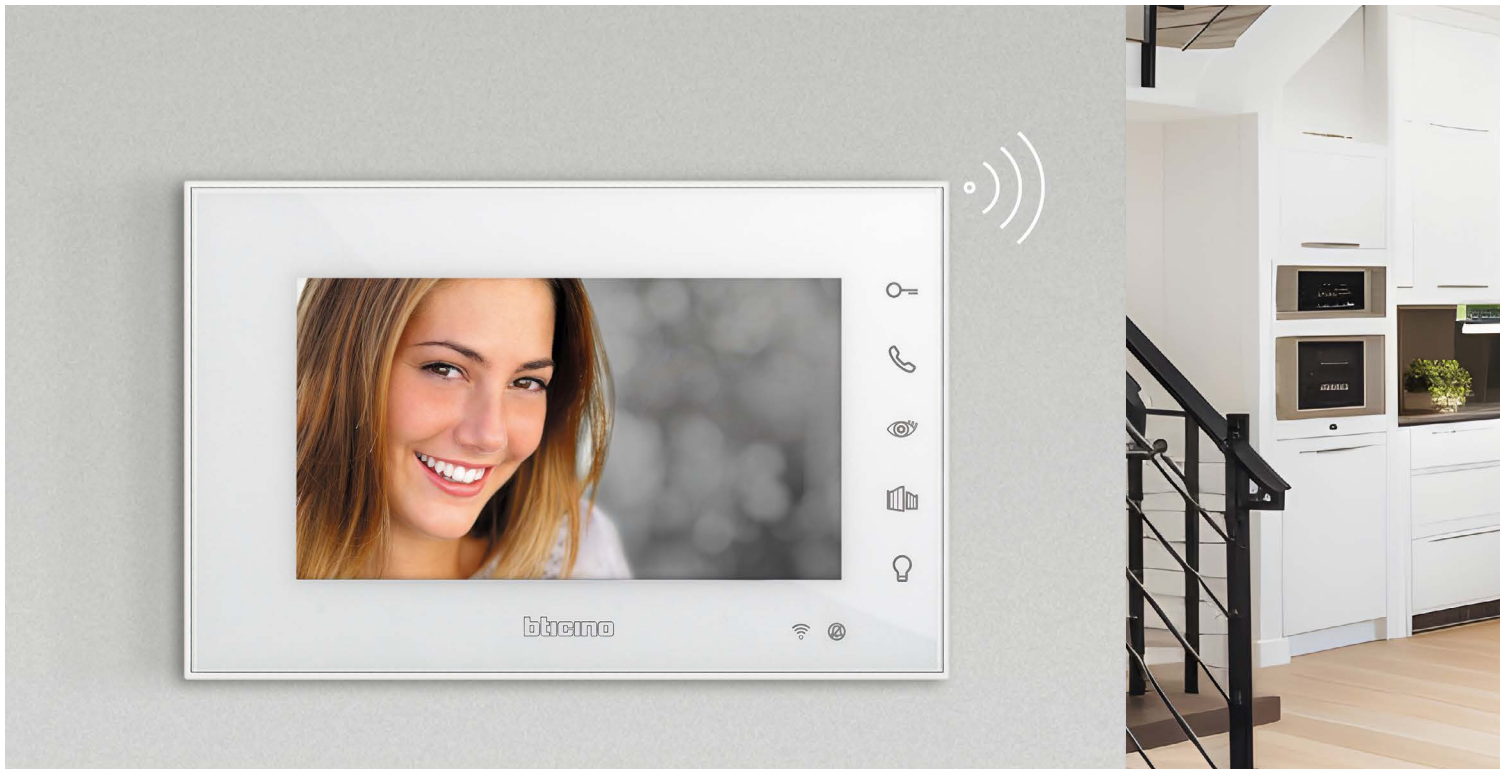

Main features:

- Easy, simple and quick installation
- SMART Wifi connected solution for your security
- 2 non-polarized wires for an error-proof connection
- Practical and functional: hands-free solutions enabling dialogue while moving freely
- High-resistant, waterproof metal entrance panels
- One family installation. Easy switch to two families by adding the additional internal unit
- Expandability with additional internal units, entrance panel and CCTV camera.

EASYKIT

"very simple" solutions



Hands-free video kits comprising:

- a wall-mounting metal entrance panel (rainshield included) equipped with a colour camera and a LED lamp for the illumination of the field of view.
- a video colour display internal unit (plug-in power supply included).



 CONNECTED VERSION	 CAMERA INTEGRATION	 PLUG-IN OR DIN POWER SUPPLY	 EXPANDABLE	 IDEAL FOR REFURBISHMENTS
------------------------------	-------------------------------	--	-----------------------	-------------------------------------



- **Easy** installation
- **Expandability** with additional internal units, entrance panel and CCTV camera
- **Connected Wifi** solution available
- **Door lock** release key and **intercom** functions
- **Plug-in** and **DIN** power supply

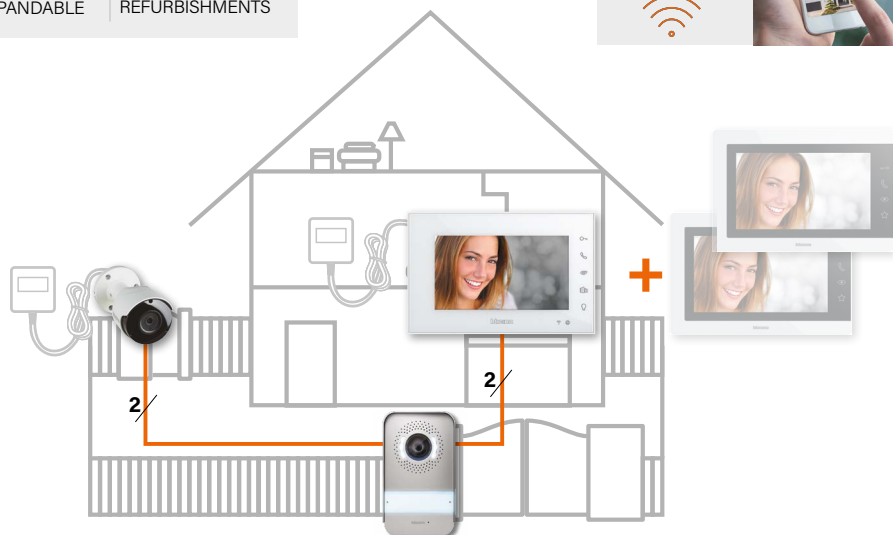

EASYKIT

2 wires



EASYKIT Wifi

Smart solution
for your security



Home + Security





Answer the calls,
activate the electrical door locks,
activate the cameras and display
the timeline of the events

Manage up to 20 homes
with your single account



Home + Security



Incoming call

Receive notification
when someone
is calling

See who's calling

Answer the call and
open the gate for
the courier

Check the events

Check who called you
and if they left you
a message

Quick actions

- Activate the electrical door locks
- Activate the timed staircase lights
- Call home / Intercom
- Activate the cameras

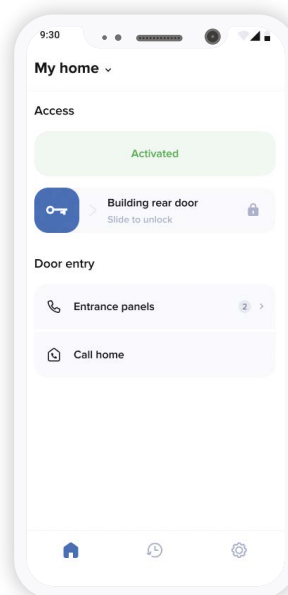
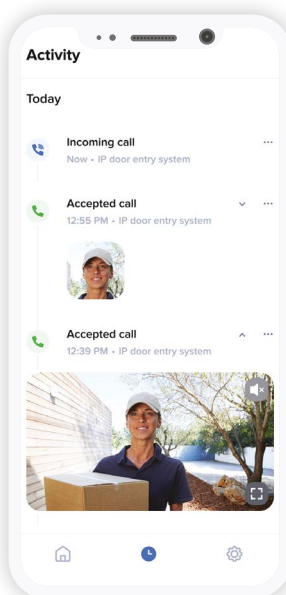
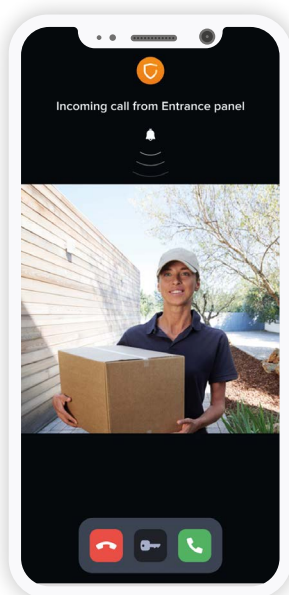
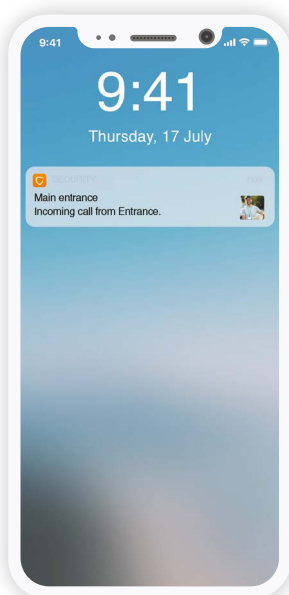

Security enhancement with integration of Netatmo devices

Video door entry system and security. Together.

Video door entry system ...



Main entrance
Incoming entrance call.

Security ...



Secondary entrance and interiors
Smart Outdoor Camera with Siren and movement detection. Smart Indoor Camera with face recognition.

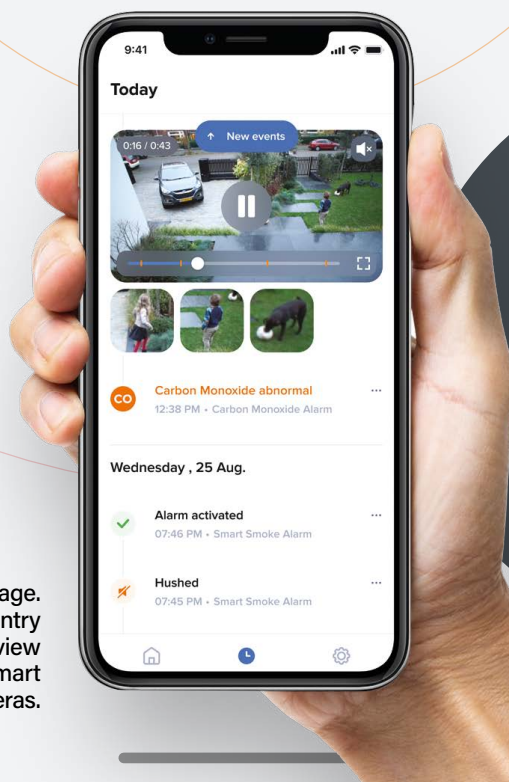

A single App with an intuitive home page. It allows you to answer video door entry calls, activate the door lock and view images from Netatmo smart outdoor and indoor cameras.



Professional opportunity: offer your services as an installer of simple smart security systems.
Business opportunities: access to a catalogue of smart and easy-to-install security devices.

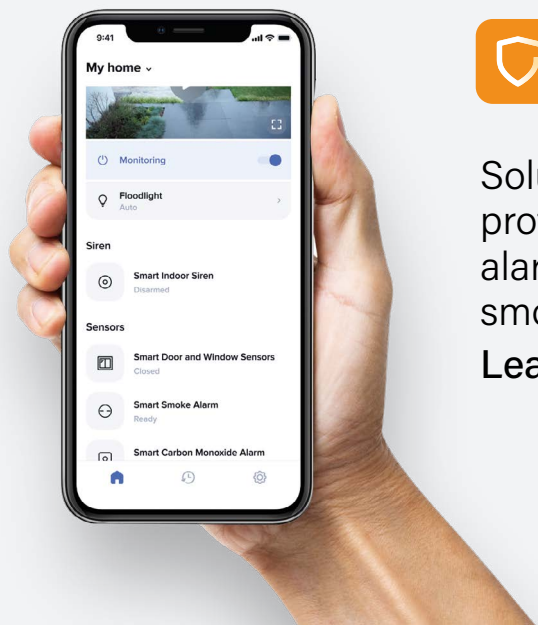

Home + Security
 The best App for a safe home.

Solutions for a smart and complete protection of your home: security cameras, alarms, opening sensors, smoke detector...

Leave your home without worries.

WITH
Netatmo

Examples of Netatmo solutions natively integrated in the Home + Security App



Smart Original
 Outdoor Camera white



Smart Original
 Outdoor Camera black



Smart Advance
 Indoor Camera white



Smart Advance
 Indoor Camera black



Smart Indoor
 Siren



Smart Smoke
 Alarm



Smart Carbon
 Monoxide Alarm

EASYKIT

2 wires



ONE
FAMILY HOUSE



Existing internal unit



TWO
FAMILY HOUSE



Existing internal unit

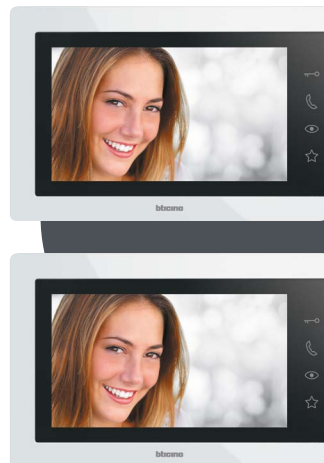

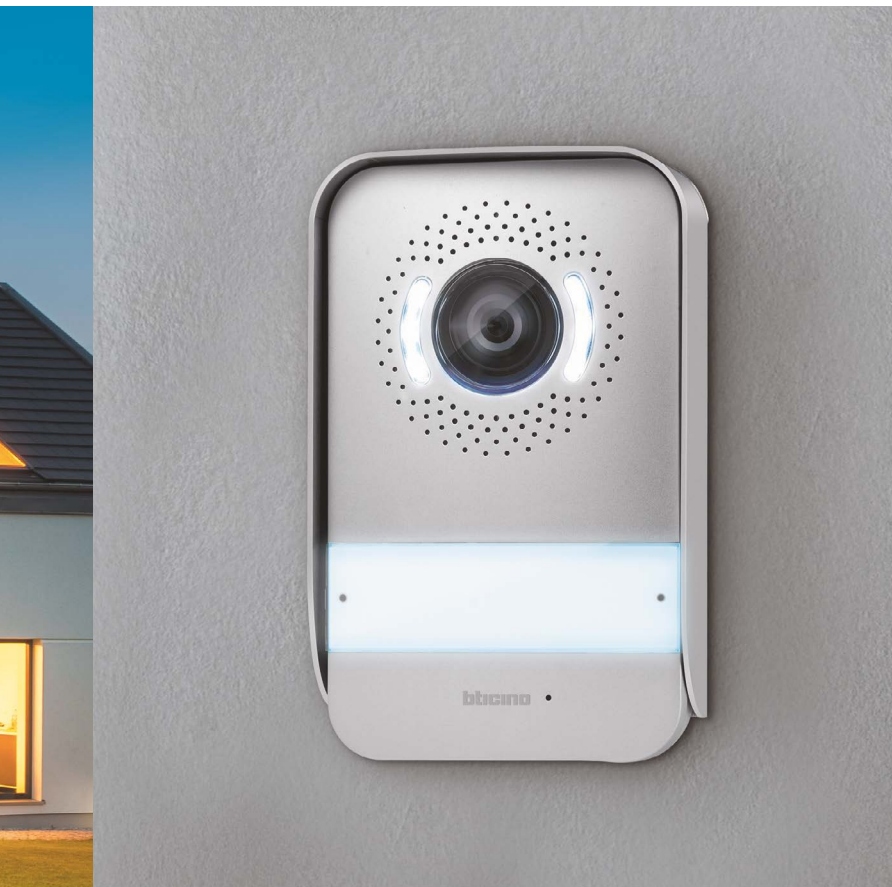

You can turn your existing system into a connected one by simply replacing the video internal unit **without structural changes.**

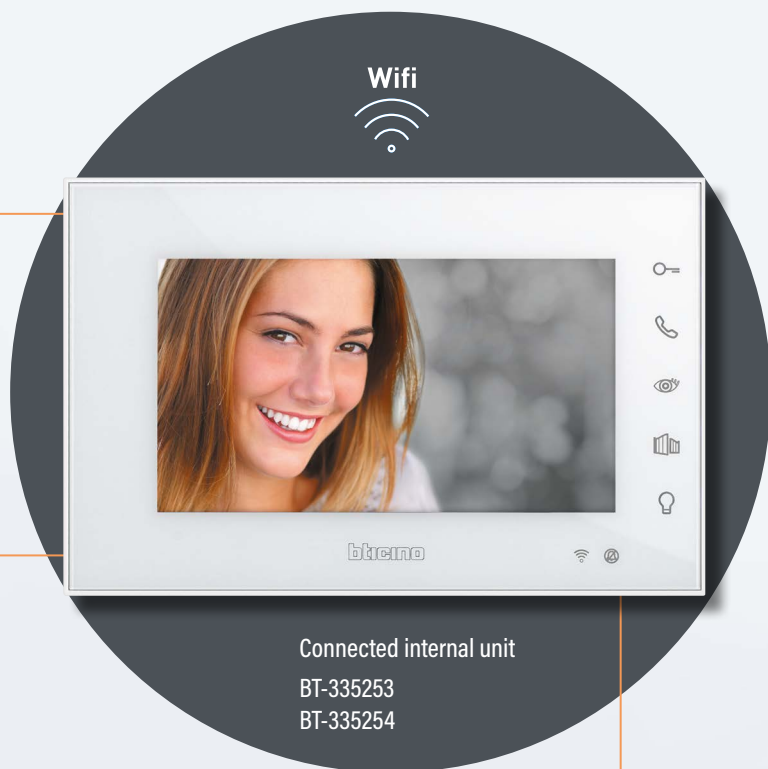

EASYKIT

Solutions



Choose your kit...

7" inch easykit Wifi video kits



- Wifi connectivity
- Management from smartphone via Home + Security app
- 7 Inch colour monitor with soft touch buttons
- White finish
- Double opening (door and gate)
- Light activation
- Integration with Netatmo Smart Cameras and Security devices
- Additional CCTV camera
- Entrance panel can call 2 apartments
- Plug-In or DIN power supply

7" inch easykit plus video kits - mirror effect



- Simple and modern
- 7 Inch colour monitor with soft touch buttons
- Mirror effect design
- Black finish
- Double opening (door and gate)
- Light activation
- Additional CCTV camera
- Entrance panel can call 2 apartments
- Plug-In or DIN power supply

7 inch easykit essential video kits







- Practical and essential
- 7 Inch colour monitor with soft touch buttons
- White finish
- Double opening (door and gate)
- Additional CCTV camera
- Entrance panel can call 2 apartments
- Plug-In or DIN power supply



and expand it

All Easykits can be expanded up to a maximum of 3 internal units and one additional entrance panel or CCTV camera for each apartment. Only one easy kit connected per home can be installed.

7 Inch Wifi additional internal units	7 Inch Plus additional internal units	7 Inch Essential additional internal units	Additional entrance panel additional camera
 <p>Plug-In or DIN Power supply</p>	 <p>Plug-In or DIN Power supply</p>	 <p>Plug-In or DIN Power supply</p>	 <p>ENTRANCE PANEL durable aluminium finishing</p> <ul style="list-style-type: none"> ■ Practical 2-wires installation ■ Weatherproof (IP54) ■ Metal protective rainshield ■ IK07 degree of protection ■ Wide-angle camera (105°) ■ LED light and night vision ■ Adaptable for one or two-family houses ■ Can be connected to a security camera



7" White finish **EASYKIT Wifi with Netatmo**

WITH PLUG-IN POWER SUPPLY

One family two wires colour **EASYKIT Wifi with Netatmo** connected video kit with plug-in power supply and wall mounted entrance panel that can be easily adapted for two family houses. An external CCTV colour camera can be directly connected to the entrance panel. Wifi connected handsfree 7" screen internal unit white finish with European Plug-In power supply included. The system can be expanded up to 3 traditional handsfree internal units. Thanks to the Wifi connection, you can associate the video internal unit to the HOME + SECURITY App (available for Android and iOS). You can manage by the App the main video internal unit functions (receiving calls, opening the door lock, view the cameras). Through the same App, it is also possible to manage the products of the Netatmo security range. This allows you to quickly and easily create a Smart security system.



7" Mirror black finish **EASYKIT Plus**

WITH PLUG-IN POWER SUPPLY

One family two wires colour **EASYKIT Plus** video kit with plug-in power supply and wall mounted entrance panel that can be easily adapted for two family houses. An external CCTV colour camera can be directly connected to the entrance panel. Handsfree 7" screen internal unit black finish mirror effect, with touch control commands for main functions and European Plug-In power supply included. The system can be expanded up to 3 traditional handsfree internal units.







7" White finish **EASYKIT Essential**

WITH PLUG-IN POWER SUPPLY

One family two wires colour **EASYKIT Essential** video kit with plug-in power supply and wall mounted entrance panel that can be easily adapted for two family houses. An external CCTV colour camera can be directly connected to the entrance panel. Handsfree 7" screen internal unit white finish with touch control commands for main functions and European Plug-In power supply included. The system can be expanded up to 3 traditional handsfree internal units.

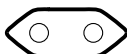



Plug-In PWS (included)	EASYKIT Wifi with Netatmo	EASYKIT Plus	EASYKIT Essential
European standard 	BT-310913 7 inch white finish screen WIFI WITH NETATMO KIT	BT-318913 7 inch black finish screen PLUS KIT	BT-317913 7 inch white finish screen ESSENTIAL KIT
	BT-335253 7 inch white finish ADDITIONAL WIFI WITH NETATMO INTERNAL UNIT	BT-334253 7 inch black finish ADDITIONAL PLUS INTERNAL UNIT	BT-333253 7 inch white finish ADDITIONAL ESSENTIAL INTERNAL UNIT
Video colour entrance panel 	BT-331860 (Additional colour entrance panel with rainshield)		
Additional External camera 	BT-391441 (European standard PLUG Colour external camera)		
Spare part Power supply 	BT-SP101 (Spare part plug-in power supply)		



NOTE: internal units are all compatible. As additional internal unit you can use any of the range.

BTICINO BRAND KITS

EASYKIT

with plug-in power supply



BT-310913



BT-318913



BT-317913



BT-335253



BT-334253



BT-333253

Item	7" White finish EASYKIT Wifi with plug-in power supply
BT-310913	<p>One family two wires colour EASYKIT Wifi connected video kit with plug-in power supply and wall mounted entrance panel. Metal finish entrance panel with rainshield, colour wide angle camera and LED for the night illumination of the field of view. Entrance panel can be easily adapted for two family houses. An external CCTV colour camera can be directly connected to the entrance panel.</p> <p>Wifi connected handsfree 7" screen internal unit white finish with European PLUG-IN std power supply included. The system can be expanded up to 3 traditional handsfree internal units.</p> <p>Thanks to the Wifi connection, you can associate the video internal unit to the Home + Security App (available for Android and iOS). You can manage by the App the main video internal unit functions (receiving calls, opening the door lock, view the cameras). Through the same App, it is also possible to manage the products of the Netatmo security range. This allows you to quickly and easily create a Smart security system.</p>
	Additional video internal units
BT-335253	Additional EASYKIT Wifi connected handsfree 7" screen internal unit white finish with EU standard plug-in power supply included. Touch control commands for main functions. Wall mounting installation. Thanks to the Wifi connection, you can associate the video internal unit to the Home + Security App (available for Android and iOS).
BT-334253	Additional EASYKIT Plus handsfree 7" screen internal unit black finish mirror effect with EU standard plug-in power supply included. Touch control commands for main functions. Wall mounting installation.
BT-333253	Additional handsfree 7" EASYKIT Essential screen internal unit white finish with EU standard plug-in power supply included. Touch control commands for main functions. Wall mounting installation.

Item	7" Mirror black finish EASYKIT Plus with plug-in power supply
BT-318913	<p>One family two wires colour EASYKIT Plus video kit with plug-in power supply and wall mounted entrance panel. Metal finish entrance panel with rainshield, colour wide angle camera and LED for the night illumination of the field of view. Entrance panel can be easily adapted for two family houses. An external CCTV colour camera can be directly connected to the entrance panel.</p> <p>Handsfree 7" screen internal unit black finish mirror effect, with touch control commands for main functions and European PLUG-IN std power supply included. The system can be expanded up to 6 internal units (3 per entrance panel) and up to 2 entrance panels.</p>
BT-317913	7" Mirror black finish EASYKIT Essential with plug-in power supply
	<p>One family two wires colour EASYKIT Essential video kit with plug-in power supply and wall mounted entrance panel. Metal finish entrance panel with rainshield, colour wide angle camera and LED for the night illumination of the field of view. Entrance panel can be easily adapted for two family houses. An external CCTV colour camera can be directly connected to the entrance panel.</p> <p>Handsfree 7" screen internal unit white finish with touch control commands for main functions and European PLUG-IN std power supply included. The system can be expanded up to 6 internal units (3 per entrance panel) and up to 2 entrance panels.</p>

EASYKIT

with plug-in power supply



BT-331860



BT-391441



BT-SP101

Item Additional video entrance panel with rainshield

BT-331860 Additional video colour entrance panel with rainshield. Wide angle colour camera (105°). IP54 Protection degree.

Additional external camera

BT-391441 Additional external colour camera with coaxial video output, metal case and 3.6 mm fixed lens. Night vision. Power supply 100-240 Vac / 50-60 Hz (12 VDC Plug-in power supply with EU standard socket supplied). Degree of protection IP66 – degree of robustness IK07. Can be connected directly to the entrance panel.

Plug-In power supply

BT-SP101 Plug-In power supply with EU Standard plug. Nominal input voltage : 110 - 240 Vac @ 50/60 Hz. Output: 30 Vdc - 1 A. Integrated fuse on PRI side (F1 T2A 250 V).

Wiring diagram example

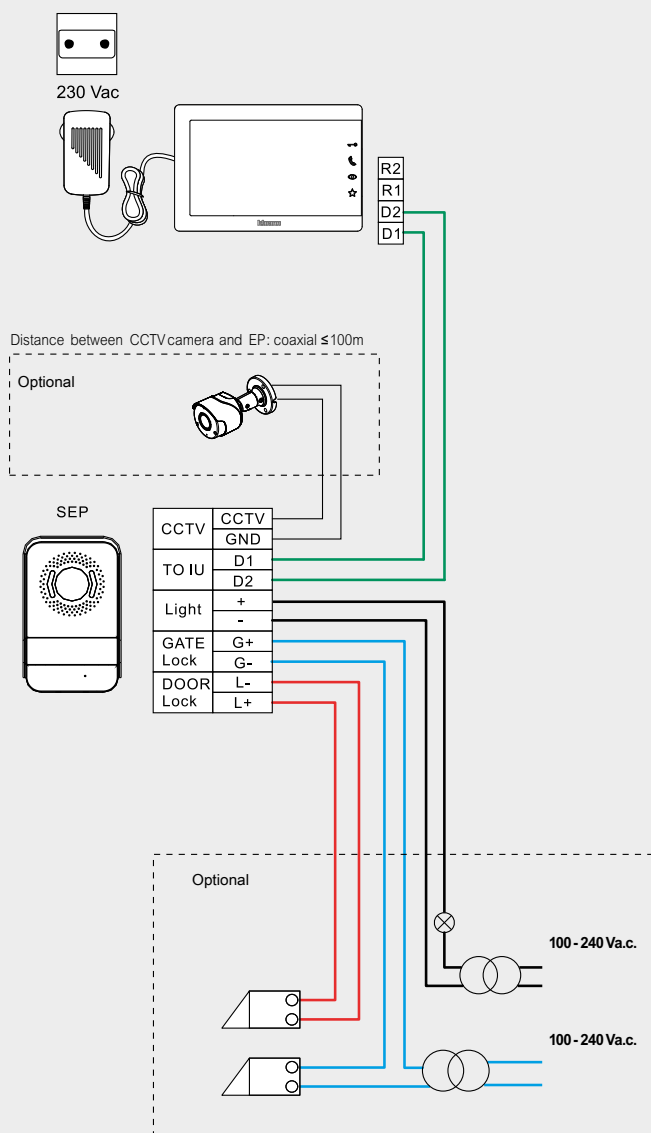



7" White finish **EASYKIT Wifi with Netatmo**

WITH DIN POWER SUPPLY

One family two wires colour **EASYKIT Wifi with Netatmo** connected video kit with 2-DIN modules power supply and wall mounted entrance panel that can be easily adapted for two family houses. An external CCTV colour camera can be directly connected to the entrance panel. Wifi connected handsfree 7" screen internal unit white finish. The system can be expanded up to 3 traditional handsfree internal units. Thanks to the Wifi connection, you can associate the video internal unit to the HOME + SECURITY App (available for Android and iOS). You can manage by the App the main video internal unit functions (receiving calls, opening the door lock, view the cameras). Through the same App, it is also possible to manage the products of the Netatmo security range. This allows you to quickly and easily create a Smart security system.



7" Mirror black finish **EASYKIT Plus**

WITH DIN POWER SUPPLY

One family two wires colour **EASYKIT Plus** video kit with 2-DIN modules power supply and wall mounted entrance panel that can be easily adapted for two family houses. An external CCTV colour camera can be directly connected to the entrance panel. Handsfree 7" screen internal unit black finish mirror effect, with touch control commands for main functions. The system can be expanded up to 3 traditional handsfree internal units.







7" White finish **EASYKIT Essential**

WITH DIN POWER SUPPLY

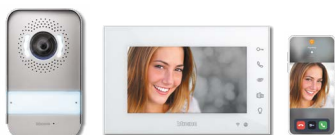
One family two wires colour **EASYKIT Essential** video kit with 2-DIN modules power supply and wall mounted entrance panel that can be easily adapted for two family houses. An external CCTV colour camera can be directly connected to the entrance panel. Handsfree 7" screen internal unit white finish with touch control commands for main functions. The system can be expanded up to 3 traditional handsfree internal units.

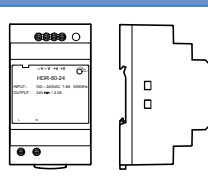



DIN PWS (included)	EASYKIT Wifi with Netatmo	EASYKIT Plus	EASYKIT Essential
	BT-310914 7" inch white finish screen WIFI WITH NETATMO KIT	BT-318914 7" inch black finish screen PLUS KIT	BT-317914 7" inch white finish screen ESSENTIAL KIT
	BT-335254 7" inch white finish ADDITIONAL WIFI WITH NETATMO INTERNAL UNIT	BT-334254 7" inch black finish ADDITIONAL PLUS INTERNAL UNIT	BT-333254 7" inch white finish ADDITIONAL ESSENTIAL INTERNAL UNIT
Video colour entrance panel 	BT-331860 (Additional colour entrance panel with rainshield)		
Additional External camera 	BT-391441 (European standard PLUG Colour external camera)		
Spare part Power supply 	BT-SP102 (2-DIN Spare part power supply)		



NOTE: internal units are all compatible. As additional internal unit you can use any of the range.

BTICINO BRAND KITS

EASYKIT

with din power supply



BT-310914



BT-318914



BT-317914



BT-335254



BT-334254



BT-333254

Item	7" White finish EASYKIT Wifi with DIN power supply
BT-310914	<p>One family two wires colour EASYKIT Wifi connected video kit with DIN power supply and wall mounted entrance panel. Metal finish entrance panel with rainshield, colour wide angle camera and LED for the night illumination of the field of view. Entrance panel can be easily adapted for two family houses. An external CCTV colour camera can be directly connected to the entrance panel.</p> <p>Wifi connected handsfree 7" screen internal unit white finish with 2 DIN modules power supply included. The system can be expanded up to 3 traditional handsfree internal units.</p> <p>Thanks to the Wifi connection, you can associate the video internal unit to the Home + Security App (available for Android and iOS). You can manage by the App the main video internal unit functions (receiving calls, opening the door lock, view the cameras). Through the same App, it is also possible to manage the products of the Netatmo security range. This allows you to quickly and easily create a Smart security system.</p>
	<p>Additional video internal units</p>
BT-335254	<p>Additional EASYKIT Wifi connected handsfree 7" screen internal unit in white finish. Touch control commands for main functions. Wall mounting installation. Thanks to the Wifi connection, you can associate the video internal unit to the Home + Security App (available for Android and iOS).</p>
BT-334254	<p>Additional EASYKIT Plus handsfree 7" screen internal unit black finish mirror effect. Touch control commands for main functions. Wall mounting installation.</p>
BT-333254	<p>Additional handsfree 7" EASYKIT Essential screen internal unit white finish. Touch control commands for main functions. Wall mounting installation.</p>

Item	7" Mirror black finish EASYKIT Plus with DIN power supply
BT-318914	<p>One family two wires colour EASYKIT Plus video kit with DIN power supply and wall mounted entrance panel. Metal finish entrance panel with rainshield, colour wide angle camera and LED for the night illumination of the field of view. Entrance panel can be easily adapted for two family houses. An external CCTV colour camera can be directly connected to the entrance panel.</p> <p>Handsfree 7" screen internal unit black finish mirror effect, with touch control commands for main functions and DIN power supply included. The system can be expanded up to 6 internal units (3 per entrance panel) and up to 2 entrance panels.</p>
BT-317914	<p>7" Mirror black finish EASYKIT Essential with DIN power supply</p> <p>One family two wires colour EASYKIT Essential video kit with DIN power supply and wall mounted entrance panel. Metal finish entrance panel with rainshield, colour wide angle camera and LED for the night illumination of the field of view. Entrance panel can be easily adapted for two family houses. An external CCTV colour camera can be directly connected to the entrance panel.</p> <p>Handsfree 7" screen internal unit white finish with touch control commands for main functions and DIN power supply included. The system can be expanded up to 6 internal units (3 per entrance panel) and up to 2 entrance panels.</p>

EASYKIT

with din power supply



BT-331860



BT-391441



BT-SP102

Item **Additional video entrance panel with rainshield**
BT-331860 Additional video colour entrance panel with rainshield. Wide angle colour camera (105°). IP54 Protection degree.

Additional external camera
BT-391441 Additional external colour camera with coaxial video output, metal case and 3.6 mm fixed lens. Night vision. Power supply 100-240 Vac / 50-60 Hz (12 VDC Plug-in power supply with EU standard socket supplied). Degree of protection IP66 – degree of robustness IK07. Can be connected directly to the entrance panel.

DIN power supply
BT-SP102 2 DIN module power supply. Nominal input voltage : 85 - 264 Vac @ 50/60 Hz. Output: 24 Vdc - 2.5 A. It must only be installed indoors and only in switchboards set up for DIN devices. Use an omnipolar switch with separation between the contacts of at least 3 mm positioned near the power supply.

Wiring diagram example

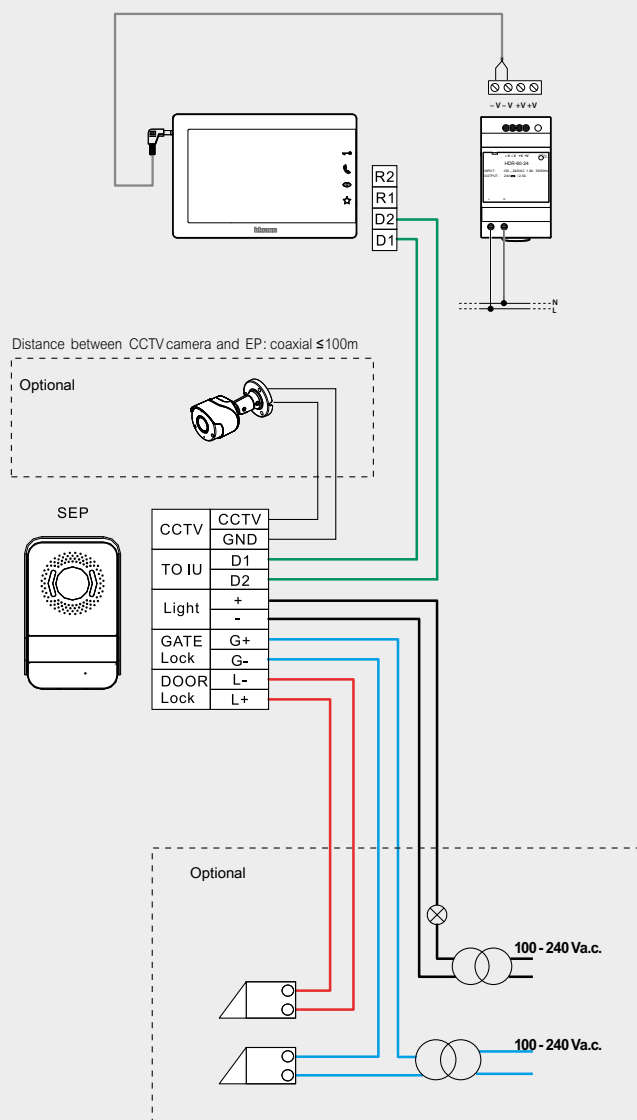

Wiring diagram 2 WIRES

Examples

EXAMPLE 1

Single family system with one entrance panel & Plug-in power supply



ONE
FAMILY HOUSE

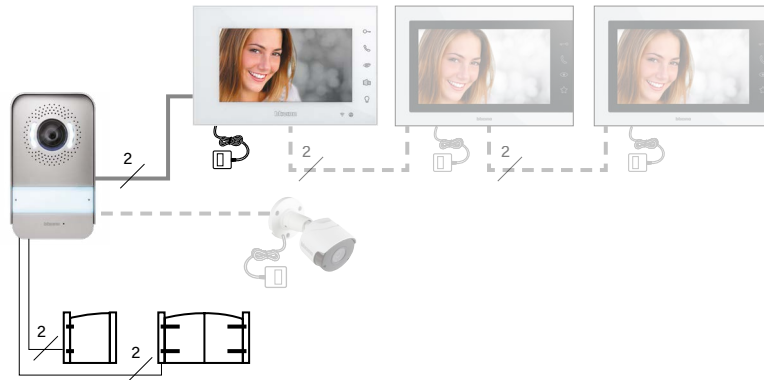

PLUG-IN power supply
(1 power supply for each monitor)

EXAMPLE 2

Single family system with one entrance panel & DIN power supply



ONE
FAMILY HOUSE

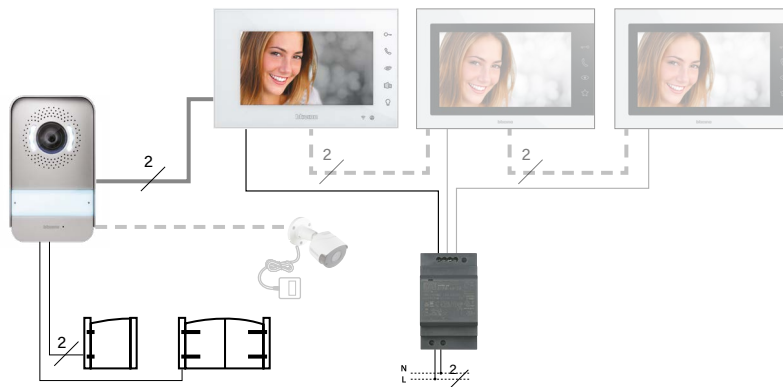

DIN power supply
(1 power supply for the entire system)

EXAMPLE 3

Two-family system with Plug-in power supply



TWO FAMILY HOUSE

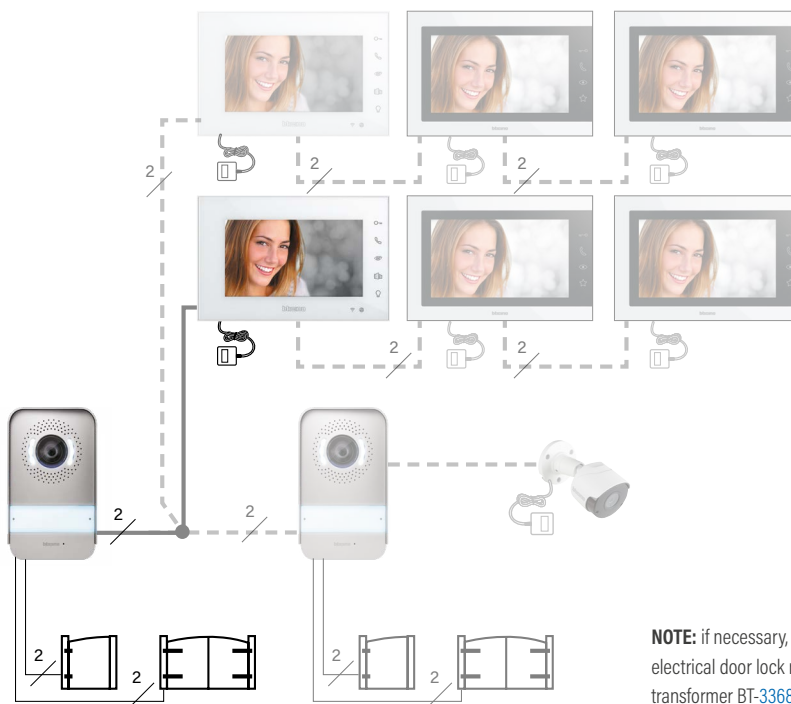

NOTE: if necessary, to control the electrical door lock release, use DIN transformer BT-336842 (230 Va.c.)

PLUG-IN power supply
(1 power supply for each monitor)

EXAMPLE 4

Two-family system with DIN power supply



TWO FAMILY HOUSE

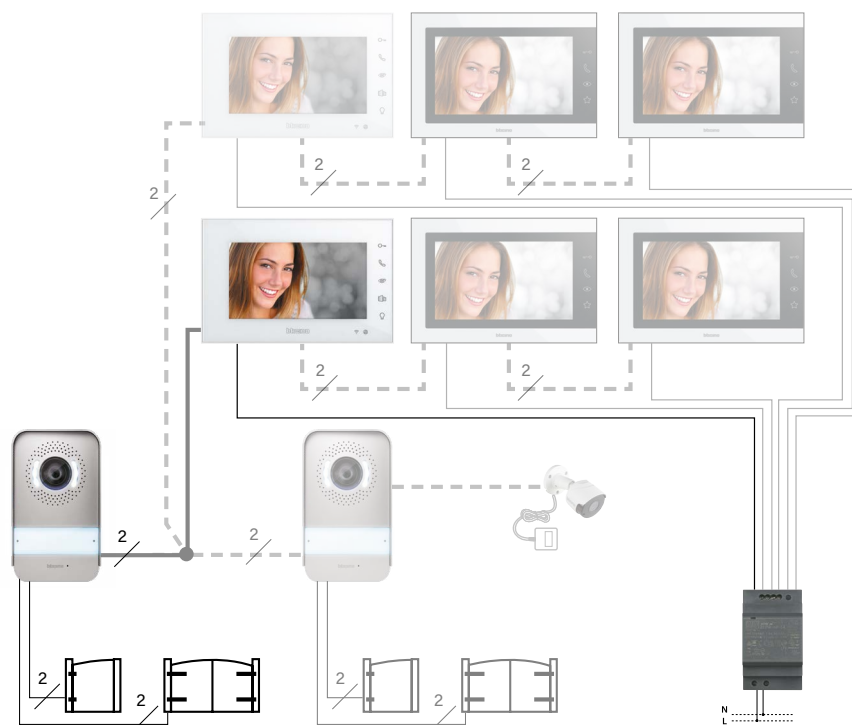

NOTE: if necessary, to control the electrical door lock release, use DIN transformer BT-336842 (230 Va.c.)

DIN power supply
(1 power supply for the entire system)

BASIC

4 wires



7" colour Video Kits

7" HANDS-FREE AND HANDSET VIDEO KITS

One-family 4-wires colour video **hands-free and handset kits**, wall mounted with internal power supply, expandable up to 4 additional internal units and up to 1 additional entrance panel or a CCTV camera, offering the basic door entry system functions: call, intercom, door lock activation, image cycling. Composed of a hands-free or handset internal unit, with a 7" colour display and 12 ringtones, signaling LED and MUTE function; and a discrete Zamak entrance panel with rain-shield, microphone and speaker volume adjustments, colour camera and LED for enhancing lighting in the visual field.



4.3" colour Video Kits

4.3" HANDS-FREE AND HANDSET VIDEO KITS

One-family 4-wires colour video **hands-free and handset kits**, wall mounted with internal power supply, expandable up to 4 additional internal units and up to 1 additional entrance panel or a CCTV camera, offering the basic door entry system functions: call, intercom, door lock activation, image cycling. Composed of a hands-free or handset internal unit, with a 4.3" colour display and 12 ringtones, signaling LED and MUTE function; and a discrete Zamak entrance panel with rain-shield, microphone and speaker volume adjustments, colour camera and LED for enhancing lighting in the visual field.







Handset Audio Kit

One-family 4-wires handset audio kit, wall mounted with internal power supply, expandable up to 4 additional internal units, offering the basic door entry system functions: call, intercom, door lock activation. Composed of a handset audio internal unit, signaling LED and MUTE function; and a discrete Zamak entrance panel with rain-shield, microphone and speaker volume adjustments.





	7" VIDEO KITS	4.3" VIDEO KITS	AUDIO KIT
Kit 	BT-315511 (7" Hands-free kit) BT-315411 (7" Handset kit)	BT-315311 (4.3" Hands-free kit) BT-315211 (4.3" Handset kit)	BT-315111 (Handset kit)
Additional internal units 	BT-330851 (Additional 7" Handsfree internal unit) BT-330751 (Additional 7" Handset internal unit)	BT-330651 (Additional 4.3" Handsfree internal unit) BT-330551 (Additional 4.3" Handset internal unit)	BT-330451 (Additional audio handset)
<p>NOTE: All internal units are compatible. You can use any unit from the range as an additional internal unit.</p>			
Additional entrance panels 	BT-330560 (Additional video entrance panel with rainshield) BT-330460 (Additional audio entrance panel with rainshield) BT-330660 (Entrance panel angle bracket accessory)		
Additional external cameras 	BT-391441 (Additional external camera – European standard)		

BTICINO BRAND KITS

BASIC Kits



BT-315511



BT-315411



BT-315311



BT-315211



BT-315111



Item	7" Video kits
	ONE-FAMILY 4-wires colour video hands-free or handset kit, wall mounted with internal power supply, expandable up to 4 additional Internal Units and up to 1 additional External Panel or an External Camera (NTSC or PAL), offering the following functions: call, intercom, door lock activation, image cycling. Composed of a hands-free or a handset Video Internal Unit, with a 7" colour display and 12 ringtones, signaling LED and MUTE function; and a discrete Zamak Entrance Panel, with rain-shield, microphone and speaker volume adjustments, colour camera and LED for enhancing lighting in the visual field.
BT-315511	7" Hands-free video kit
BT-315411	7" Handset video kit

Item	Audio kit
	ONE-FAMILY 3-wires handset Audio kit, wall mounted with internal power supply, expandable up to 4 additional Internal Units, offering the following functions: call, intercom, door lock activation. Composed of a handset Audio Internal Unit, signaling LED and MUTE function; and a discrete Zamak Entrance Panel with rain-shield, microphone and speaker volume adjustments.
BT-315111	Handset audio kit

Item	4.3" Video kits
	ONE-FAMILY 4-wires colour video hands-free or handset kit, wall mounted with internal power supply, expandable up to 4 additional Internal Units and up to 1 additional External Panel or an External Camera (NTSC or PAL), offering the following functions: call, intercom, door lock activation, image cycling. Composed of a hands-free or a handset Video Internal Unit, with a 4,3" colour display, signaling LED and MUTE function; and a discrete Zamak Entrance Panel, with rain-shield, microphone and speaker volume adjustments, colour camera and LED for enhancing lighting in the visual field.
BT-315311	4.3" Hands-free video kit
BT-315211	4.3" Handset video kit



BT-330851



BT-330751



BT-330651



BT-330551



BT-330451



BT-330560



BT-330460



BT-330660



BT-391441

Item	Additional 7" Video Internal Units
BT-330851	Colour video hands-free additional Internal Unit, recommended to expand a ONE FAMILY BASIC 4-wires Video Kit, wall mounted with internal power supply, a 7" colour display and 12 ringtones, signaling LED and MUTE function, offering the following functions: call, intercom, door lock activation, image cycling.
BT-330751	Colour video handset additional internal unit, recommended to expand a ONE FAMILY BASIC 4-wires Video Kit, wall mounted with internal power supply, a 7" colour display and 12 ringtones, signaling LED and MUTE function, offering the following functions: call, intercom, door lock activation, image cycling.
	Additional 4.3" Video Internal Units
BT-330651	Colour video hands-free additional Internal Unit, recommended to expand a ONE FAMILY BASIC 4-wires Video Kit, wall mounted with internal power supply, a 4,3" colour display and 12 ringtones, signaling LED and MUTE function, offering the following functions: call, intercom, door lock activation, image cycling.
BT-330551	Colour video handset additional Internal Unit, recommended to expand a ONE FAMILY BASIC 4-wires Video Kit, wall mounted with internal power supply, a 4,3" colour display and 12 ringtones, signaling LED and MUTE function, offering the following functions: call, intercom, door lock activation, image cycling.
	Additional Audio handset Internal Unit
BT-330451	Audio handset additional Internal Unit, recommended to expand ONE FAMILY BASIC Video or Audio Kit, wall mounted with internal power supply, signaling LED and MUTE function, offering the following functions: call, intercom and door lock activation.

Item	Additional Video Entrance Panel
BT-330560	Additional Zamak Entrance Panel, recommended to expand a ONE FAMILY BASIC 4-wires Video Kit, wall mounted with embedded rain-shield, microphone and speaker volume adjustments, colour camera and LED for enhancing lighting in the visual field.
	Additional Audio Entrance Panel
BT-330460	Additional Zamak Entrance Panel, recommended to expand a ONE FAMILY BASIC Audio or Video Kit, wall mounted with embedded rain-shield, microphone and speaker volume adjustments.
	Angle Bracket accessory
BT-330660	Accessory for the installation of the External Panels BT-330560 - BT-330460 to adjust its visual field by a 30°-angle, to the right or to the left.
	Additional External Camera
	External colour camera, IP66 Protection Degree, PAL video system, with plug-in power supply included.
BT-391441	European standard plug version

Wiring diagram

4 WIRES



Examples

EXAMPLE 1

Single family standard video system



ONE FAMILY HOUSE

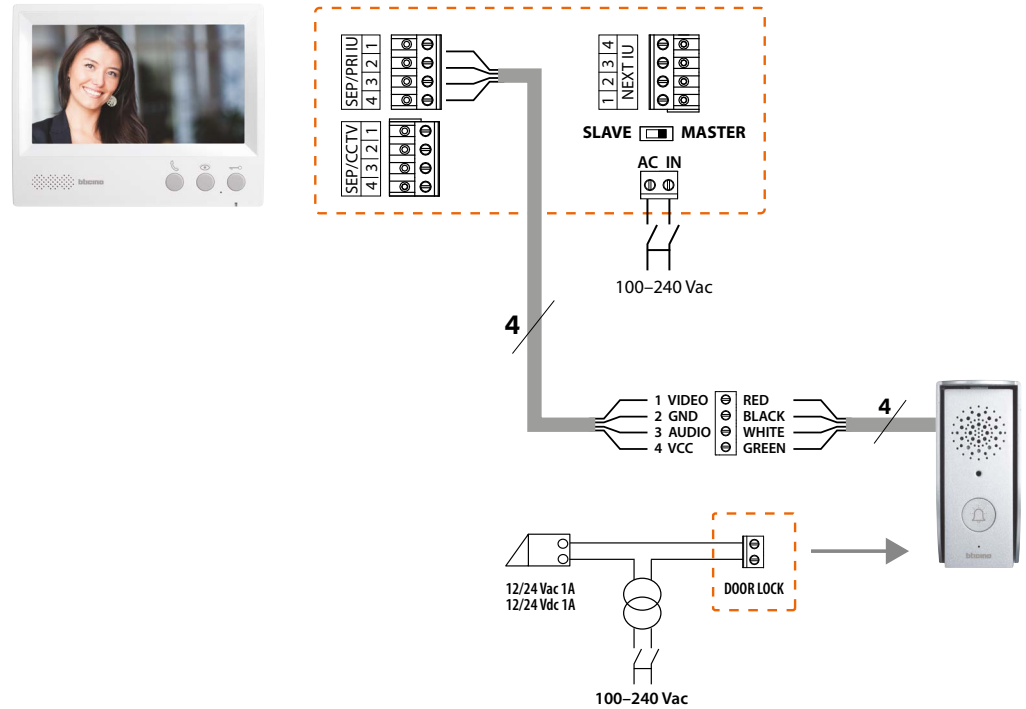

EXAMPLE 2

Single family standard audio system



ONE FAMILY HOUSE

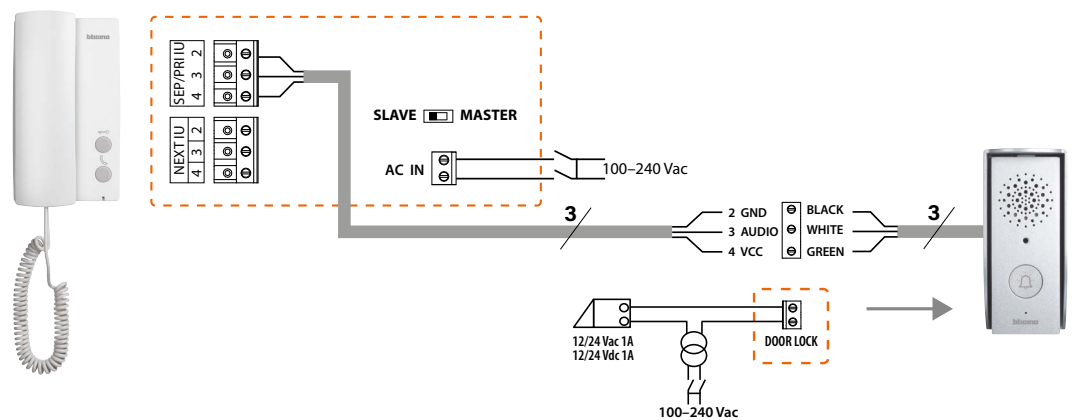

PROFESSIONAL

KITS

Suitable for villa standard - high level applications

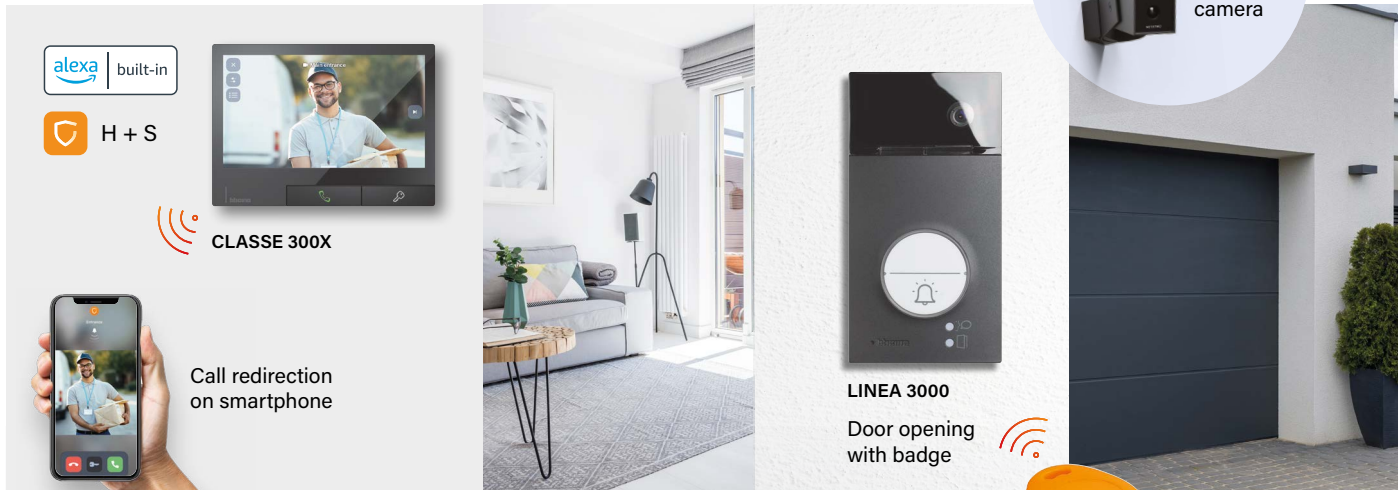

- The 2-wires technology allows maximum flexibility and expandability
- From basic functions to advanced functions such as call redirection on smartphone, video door entry answering machine, Netatmo cameras integration, intercom and door opening with badge
- Modular DIN-rail power supply
- Include a manual with all the technical information required for the installation, connection, features and expansion possibilities.



EXPANSION
Expand these kits with other devices such as additional entrance panels, internal units, cameras, and home automation devices.

2 WIRES

FULL EXPANDIBILITY

AUDIO KITS

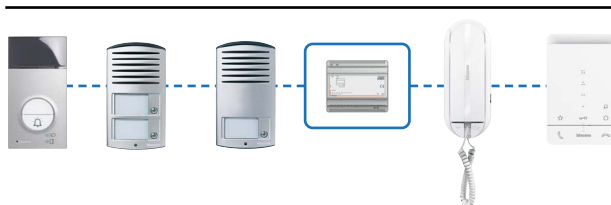

VIDEO KITS



Maximum simplicity

The 2-Wires Professional Kits offer unparalleled simplicity and flexibility in installation, making them the perfect choice for both new systems and renovations.

These kits allow for the installation of both audio and video systems using just 2 wires, enabling the use of existing wiring during renovations. Additionally, there is no need to worry about polarity in the connections, which significantly simplifies the installation process.

LINEA 3000

One family audio Kit - installation example



ONE
FAMILY HOUSE

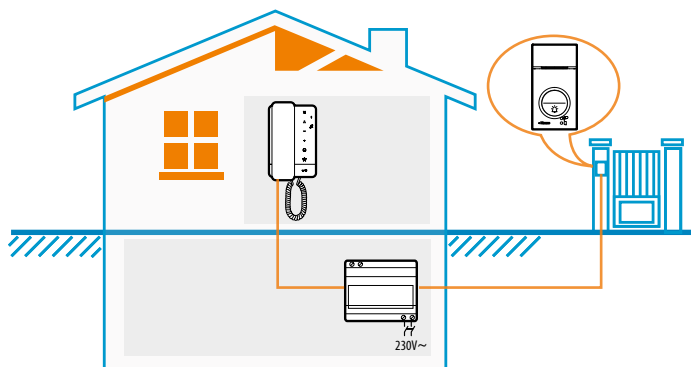

ONE FAMILY AUDIO KIT 364231

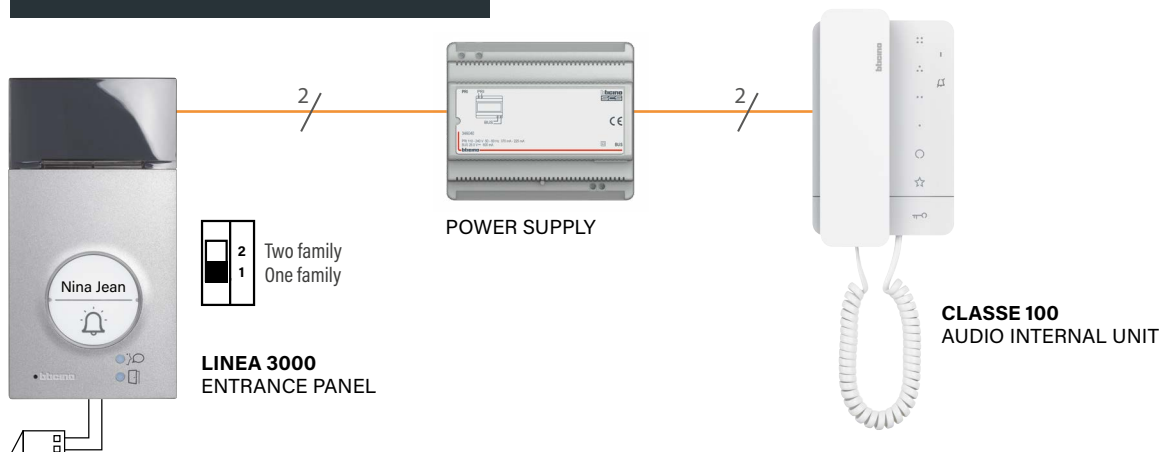



VIDEO KIT



AUDIO KIT

The 2-Wires Kits are fully expandable and designed to meet all installation needs. They are perfectly compatible with the 2 wires system devices, including external pushbutton panels, internal units, video internal units, system accessories, and cameras, allowing for seamless expansion without compromise.

LINEA 3000

Two family video Kit - installation example

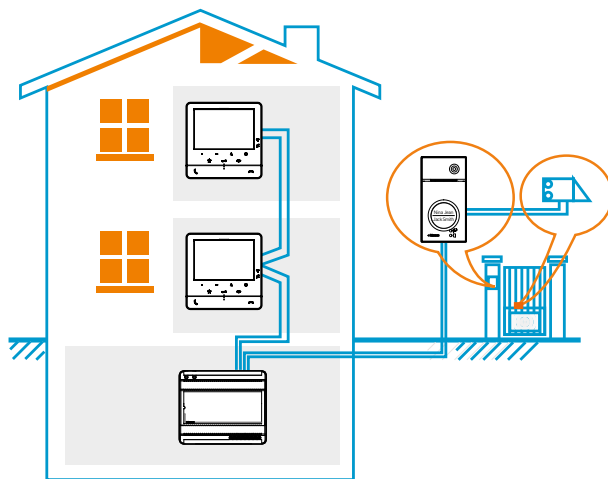

ADDITIONAL
INTERNAL UNIT
344672



ONE FAMILY VIDEO KIT 364612

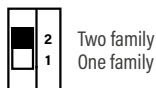

**LINEA 3000
ENTRANCE PANEL**

POWER SUPPLY

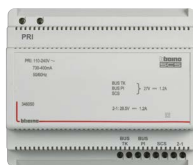

PROFESSIONAL KITS

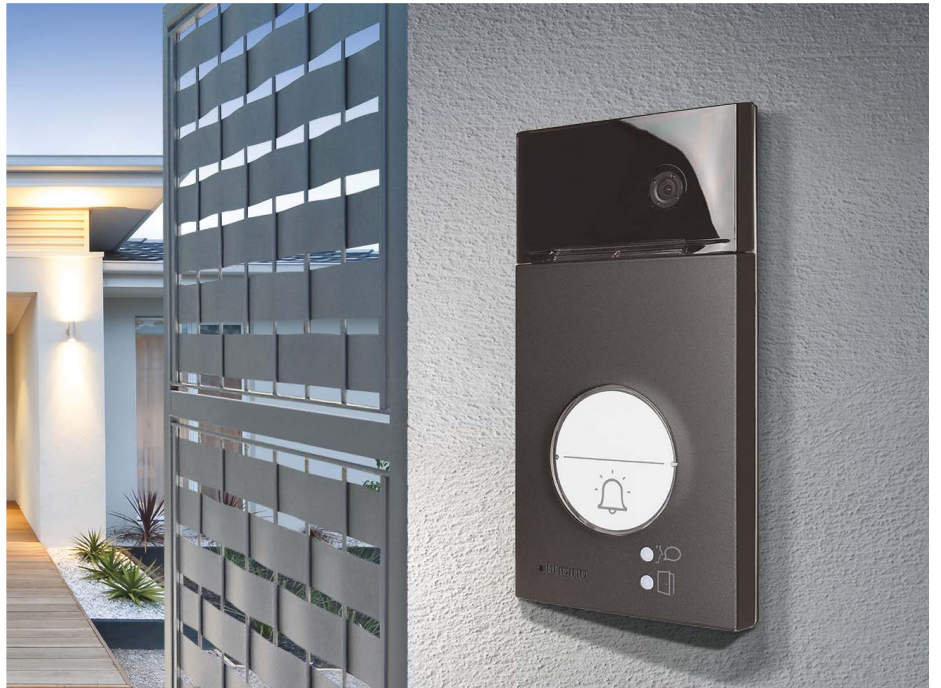
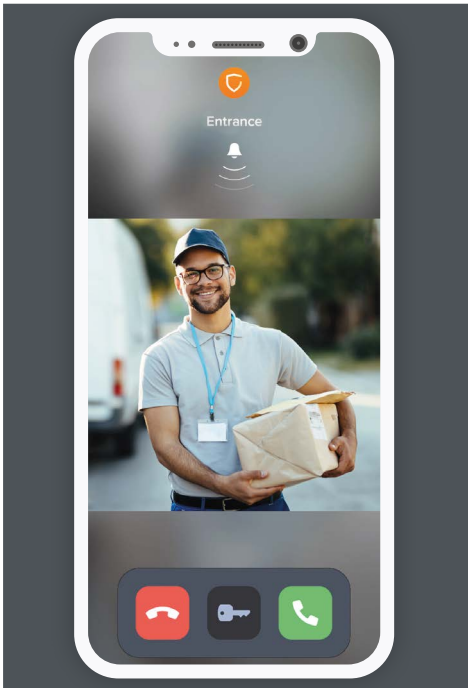

Villa connected video Kits



363942

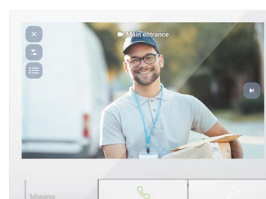

Item **Classe 300X Light – Linea 3000 Black connected Video kit**

One-family kit with CLASSE 300X hands-free connected video internal unit (Light finish) and LINEA 3000 pushbutton panel (black finish). 2 wires/Wi-Fi hands-free connected video internal unit, Light finish, with 7" horizontal touch screen LCD display, resolution 1024 x 600 pixel. Featuring a digital echo canceller for better audio quality. Thanks to the Wi-Fi 6 connectivity, the video internal unit can connect to 5 GHz or 2.4 GHz band routers to take advantage of the functions available on the Home + Security App (available for Android and iOS): call reception, door lock release, event timeline display, entrance panel activation, camera scrolling and advanced «Professional Studio» and «Do Not Disturb» functions. Through the Home + Security App, it is also possible to manage the products of the Netatmo security range (outdoor and indoor cameras, indoor siren and smoke detector). This allows you to quickly and easily create a Smart security system. LINEA 3000 pushbutton panel with black finish zamak front cover and proximity reader with a kit of coloured RFID key cards and two clear discs for door lock release. Can be wall or flush installed with specific accessories: (350020) flush mounted box and (343063) flush mounted accessory - to be purchased separately. Can be fitted with rainshield (343053) - to be purchased separately. The pushbutton panel has a protection index IP54 - protection index against mechanical impact IK10.

363942 Complete one family kit

(Easy switch to two families system by purchasing an additional internal unit - refer to 2 Wires system internal units range).

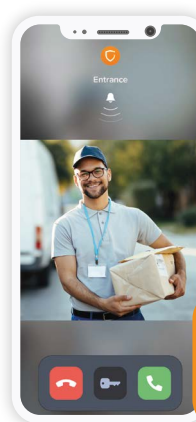

HOME + SECURITY is the App that allows, through the smartphone, to manage calls locally and remotely of the video door phone or with a simple touch to open the gate, the activation of the cameras, and switching on of the timed lights in the garden. Allows you to activate and view images of Netatmo Smart Outdoor and Indoor Cameras. Setting up the App requires a few steps and thanks to the BTicino Cloud, the remote connection is fully automated and managed with the highest level of security.

Item	Kit composition	Qty
343093	LINEA 3000 pushbutton panel (black finish)	1
344742	CLASSE 300X Smart internal unit (Light finish)	1
346050	6 DIN SCS power supply	1
346250	Door lock relay accessory	1
348260	Set of coloured door lock release key cards	1
	Set of door lock release clear discs	1



363942



Item **Classe 300X Dark – Linea 3000 Black connected Video kit**

One-family kit with CLASSE 300X hands-free connected video internal unit (Dark finish) and LINEA 3000 pushbutton panel (black finish). 2 wires/Wi-Fi hands-free connected video internal unit, Dark finish, with 7" horizontal touch screen LCD display, resolution 1024 x 600 pixel. Featuring a digital echo canceller for better audio quality. Thanks to the Wi-Fi 6 connectivity, the video internal unit can connect to 5 GHz or 2.4 GHz band routers to take advantage of the functions available on the Home + Security App (available for Android and iOS): call reception, door lock release, event timeline display, entrance panel activation, camera scrolling and advanced «Professional Studio» and «Do Not Disturb» functions. Through the Home + Security App, it is also possible to manage the products of the Netatmo security range (outdoor and indoor cameras, indoor siren and smoke detector). This allows you to quickly and easily create a Smart security system. LINEA 3000 pushbutton panel with black finish zamak front cover and proximity reader with a kit of coloured RFID key cards and two clear discs for door lock release. Can be wall or flush installed with specific accessories: (350020) flush mounted box and (343063) flush mounted accessory - to be purchased separately. Can be fitted with rainshield (343053) - to be purchased separately. The pushbutton panel has a protection index IP54- protection index against mechanical impact IK10.

363943

Complete one family kit

(Easy switch to two families system by purchasing an additional internal unit - refer to 2 Wires system internal units range).

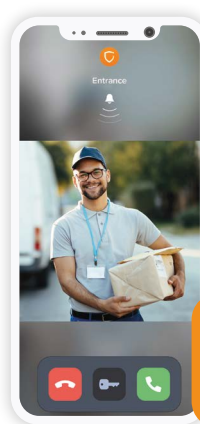

HOME + SECURITY is the App that allows, through the smartphone, to manage calls locally and remotely of the video door phone or with a simple touch to open the gate, the activation of the cameras, and switching on of the timed lights in the garden. Allows you to activate and view images of Netatmo Smart Outdoor and Indoor Cameras. Setting up the App requires a few steps and thanks to the BTicino Cloud, the remote connection is fully automated and managed with the highest level of security.

Item	Kit composition	Qty
343093	LINEA 3000 pushbutton panel (black finish)	1
344743	CLASSE 300X Smart internal unit (Dark finish)	1
346050	6 DIN SCS power supply	1
346250	Door lock relay accessory	1
348260	Set of coloured door lock release key cards	1
	Set of door lock release clear discs	1

Villa connected video Kits



364614



Item **Classe 100X16E - LINEA 3000 connected video kit**

One-family handsfree kit with: Classe 100X16E Wifi video internal unit, handsfree function, inductive loop, 5" LCD display; LINEA 3000 pushbutton panel with zamak front cover, wide angle colour camera, proximity reader and with a set of coloured key cards and two clear discs for door lock release. Can be configured for one-family and two-family installations. Nameplate lit by white LED. Can be wall or flush installed with specific accessories: (350020) flush mounted box and (343061) flush mounted accessory - to be purchased separately. Can be fitted with rainshield (343051) - to be purchased separately. The pushbutton panel has a protection index IP54- protection index against mechanical impact IK10. The video internal unit has 4.3" colour LCD display and Inductive Loop function (to enable use by people wearing hearing aids fitted with T selector). It also has 3 touch keys for the control of the main functions – door lock release, staircase light control and entrance panel activation/scrolling – there are further 4 configurable touch keys that perform different functions – e.g. staircase light control, intercom, additional door lock activation, generic activations. It has a side lever to adjust: colour, brightness and display contrast, audio volume, call tone volume and Wi-Fi configuration. There are call exclusion notification LEDs and Wifi. Also, thanks to the Wifi connection, you can associate the video internal unit to the Home + Security App (available for Android and iOS). Through the Home + Security App it is also possible to manage the products of Netatmo security offer. The installation can be made to the wall using the bracket supplied or using table support accessories (2 x 344692) – to be purchased separately. The device, also equipped with the professional studio (office) function, must be configured.

364614 Complete one family kit

(Easy switch to two families system by purchasing an additional internal unit - refer to 2 Wires system internal units range).

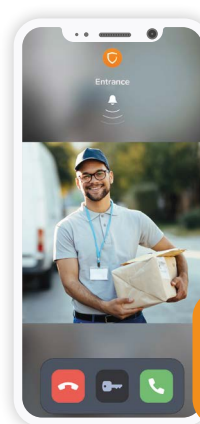

HOME + SECURITY is the App that allows, through the smartphone, to manage calls locally and remotely of the video door phone or with a simple touch to open the gate, the activation of the cameras, and switching on of the timed lights in the garden. Allows you to activate and view images of Netatmo Smart Outdoor and Indoor Cameras. Setting up the App requires a few steps and thanks to the BTicino Cloud, the remote connection is fully automated and managed with the highest level of security.

Item	Kit composition	Qty
343091	LINEA 3000 pushbutton panel (grey finish)	1
344682	CLASSE 100X16E video internal unit	1
346050	6 DIN SCS power supply	1
346250	Door lock relay accessory	1
348260	Set of coloured door lock release key cards	1
	Set of door lock release clear discs	1

Villa video kits



364612

Item **Classe 100V16E - LINEA 3000 video kit**

One-family handsfree kit with CLASSE 100V16E video indoor unit and LINEA 3000 pushbutton panel with zamak front cover and wide angle colour camera. Can be configured for one-family or two-family installations. Nameplate lit by white LED. Can be wall or flush installed with specific accessories: (350020) flush mounted box with (343061) flush mounted accessory - to be purchased separately. Can be fitted with rainshield (343051) – to be purchased separately. The pushbutton panel has a protection index IP54 - protection index against mechanical impact IK10. The video indoor unit has 5" LCD display and Inductive Loop function (to enable use by people wearing hearing aids fitted with T selector). It has 2 physical keys for the control of the main functions – answer and end a call – and has 3 touch keys for the control of the main functions – door lock release, staircase light control and entrance panel activation/scrolling – there are further 4 configurable touch keys that perform different functions – e.g. intercom, additional door lock activation, generic activations. Wall mounted installation with the bracket supplied or table installation with support accessories (2 x 344692) - to be purchased separately. The device also has Professional Studio (Office) function and must be configured.

364612 Complete one family kit

(Easy switch to two families system by purchasing an additional internal unit - refer to 2 Wires system internal units range).

Kit composition

	Qty
343081 LINEA 3000 Entrance panel (grey finish)	1
344672 CLASSE 100V16E Video internal unit	1
346050 6 DIN System power supply	1
346250 Relay module accessory	1

Villa video kits



364613



364622

Item **Classe 100V16E - LINEA 2000 video kit**

364613 One-family handsfree video kit consisting of: CLASSE 100V16B video indoor unit, LINEA 2000 pushbutton panel with colour camera and 1 call pushbutton. The push-button panel has a protection index against mechanical impact IK07 and protection index IP54. The video indoor unit has 2 physical keys for the control of the main video door entry functions – answer and end a call – and 3 touch keys that allow the door lock release, the entrance panel activation/scrolling and the customization of a most frequently used quick action – e.g. staircase light control, intercom, additional door lock activation, generic activations. The video indoor unit has a 5" colour LCD display and a side lever to adjust: colour, brightness and display contrast, audio and call tone volume. There is a call exclusion notification LED. Wall mounted installation with the bracket supplied or table installation with support accessories (2 x [344692](#)) - to be purchased separately.

Kit composition		Qty
343031	LINEA 2000 Entrance panel - 1 CALL	1
344652	CLASSE 100V16B Video internal unit	1
346050	6 DIN System power supply	1
346250	Relay module accessory	1

Item **Classe 100V16B - LINEA 2000 video kit**

364622 Two-families handsfree video kit consisting of: CLASSE 100V16B video indoor units, LINEA 2000 pushbutton panel with colour camera and 2 call pushbuttons. The push-button panel has a protection index against mechanical impact IK07 and protection index IP54. The video indoor units has 2 physical keys for the control of the main video door entry functions – answer and end a call – and 3 touch keys that allow the door lock release, the entrance panel activation/scrolling and the customization of a most frequently used quick action – e.g. staircase light control, intercom, additional door lock activation, generic activations. The video indoor units has a 5" colour LCD display and a side lever to adjust: colour, brightness and display contrast, audio and call tone volume. There is a call exclusion notification LED. Wall mounted installation with the bracket supplied or table installation with support accessories (2 x [344692](#)) - to be purchased separately.

Kit composition		Qty
343032	LINEA 2000 Entrance panel - 2 CALLS	1
344652	CLASSE 100V16B Video internal unit	2
346050	6 DIN System power supply	1
346250	Relay module accessory	1

Villa audio kits



364232



364231

Item **Classe 100A16E - LINEA 3000 hands free audio kit**

364232 One-family handsfree kit with CLASSE 100A16E audio indoor unit and LINEA 3000 pushbutton panel with zamak front cover. Can be configured for one-family or two-family installations. Nameplate lit by white LED. Can be wall or flush installed with specific accessories: (350020) flush mounted box with (343061) flush mounted accessory - to be purchased separately. Can be fitted with rainshield (343051) – to be purchased separately. The pushbutton panel has a protection index IP54 – protection index against mechanical impact IK10. The indoor unit has 2 physical keys for the control of the main door entry functions – answer and end a call – and has 3 touch keys for the control of the main functions – door lock release, staircase light control and entrance panel activation/scrolling – there are further 4 configurable touch keys that perform different functions – e.g. intercom, additional door lock activation, generic activations. Ringtone volume adjustment (with call exclusion) using the appropriate selector. The installation can be made to the wall using the bracket supplied or using table support accessory (1 x 344692) – to be purchased separately. The device also has Professional Studio (Office) function and must be configured.

Kit composition

Item	Description	Qty
343071	LINEA 3000 Audio entrance panel	1
344282	CLASSE 100A16E Audio internal unit	1
346040	6 DIN System power supply	1

Item **Classe 100A16M - LINEA 3000 audio kit with hand set**

364231 One-family audio kit with CLASSE 100A16M audio indoor unit and LINEA 3000 pushbutton panel with zamak front cover. Can be configured for one-family or two-family installations. Nameplate lit by white LED. Can be wall or flush installed with specific accessories: (350020) flush mounted box with (343061) flush mounted accessory – to be purchased separately. Can be fitted with rainshield (343051) – to be purchased separately. The pushbutton panel has a protection index IP54 – protection index against mechanical impact IK10. The audio indoor unit has 3 touch keys for the control of the main functions – door lock release, staircase light control and entrance panel activation/scrolling – there are further 4 configurable touch keys that perform different functions – e.g. intercom, additional door lock activation, generic activations. Ringtone volume adjustment (with call exclusion) using the appropriate selector. The installation can be made to the wall using the bracket supplied or using table support accessory (1 x 344692) – to be purchased separately. The device also has Professional Studio (Office) function and must be configured.

Kit composition

Item	Description	Qty
343071	LINEA 3000 Audio entrance panel	1
344292	CLASSE 100A16M Audio internal unit	1
346040	6 DIN System power supply	1

Villa audio kits



366811



366821



364211



Item SPRINT L2 – LINEA 2000 audio handset audio kit

Audio kit with audio handset SPRINT L2 and LINEA 2000 pushbutton panel. 2 WIRE technology. The audio handset has a door lock release pushbutton and a pushbutton that can be configured for auxiliary functions (staircase light switching on, entrance panel activation, call to the switchboard). Devices suitable for wall mounted installation. Expandable with additional audio handset [344242](#).

366811 Complete one-family kit

366821 Complete two-family kit

Kit composition

342911	LINEA 2000 Entrance panel - 1 CALL
342921	LINEA 2000 Entrance panel - 2 CALLS
344232	SPRINT L2 audio handset
346040	6 DIN System power supply

	366811	366821
Qty		
	Qty	Qty
	1	-
	-	1
	1	2
	1	1

Item Audio handsfree - LINEA 2000

364211 One-family expandable audio kit with audio handsfree internal unit and LINEA 2000 pushbutton panel. The audio internal unit can manage with (1 – 2) pushbuttons on board two independent contacts (24 Vac/dc – 1 A max.) Entrance panel and internal unit are suitable for wall mounted installation. Expansion possibility using the specific additional handsfree internal unit [331650](#)

Kit composition

342911	LINEA 2000 Entrance panel - 1 CALL	Qty	1
331650	Audio handsfree internal unit		1
346040	6 DIN System power supply		1

PROFESSIONAL KITS

Analogue Kits

audio Kits



363211



Item	Sprint - LINEA 2000 audio Kit handset audio kit		
	Kit with SPRINT handset and LINEA 2000 pushbutton panel, aluminium finish. Devices suitable for wall mounted installation.		
363211	Complete one-family kit		
363221	Complete two-family kit		
	Kit composition		
-	LINEA 2000 Entrance panel - 1 CALL	363211	363221
		Qty	Qty
-	LINEA 2000 Entrance panel - 2 CALLS	1	-
		-	1
334202	SPRINT Audio handset	1	2
336000	6 DIN System power supply	1	1

■ One family audio system

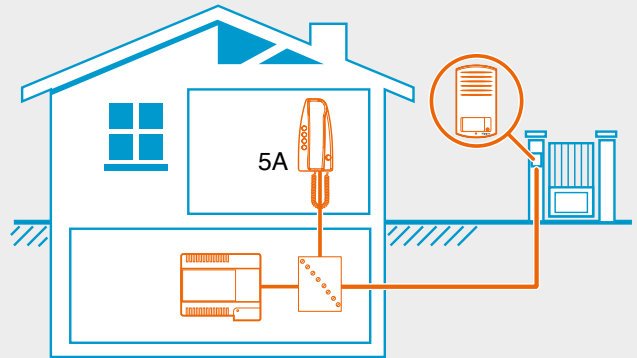

■ Two family audio system

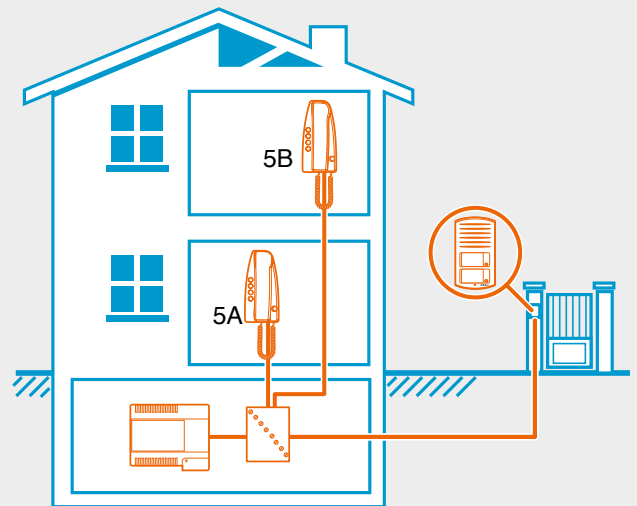

Analogue Kits

audio Kits



363811



Item **Sprint - LINEA 2000 audio handset kit**
363811 One-family kit with SPRINT handset and LINEA 2000 pushbutton panel. Analogue technology with 2 wire connection. Devices suitable for wall mounted installation. Expansion possibility using the specific additional handset **331550**

Item	Kit composition	Qty
-	LINEA 2000 Entrance panel	1
-	SPRINT audio handset	1
336842	2 DIN Transformer	1
Accessories		
331550	Specific additional audio handset	

Old bell system

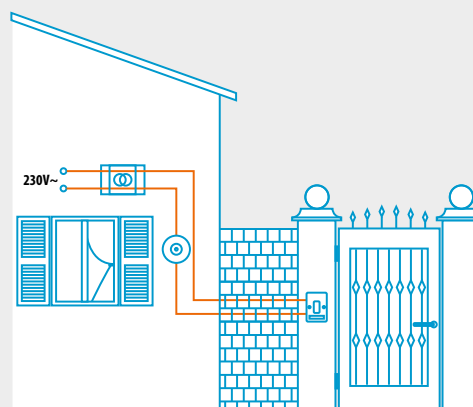

New audio system

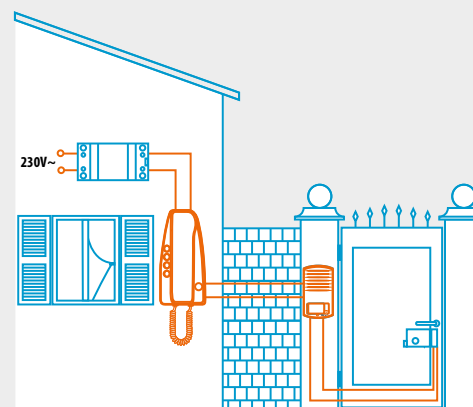

Wiring diagram example

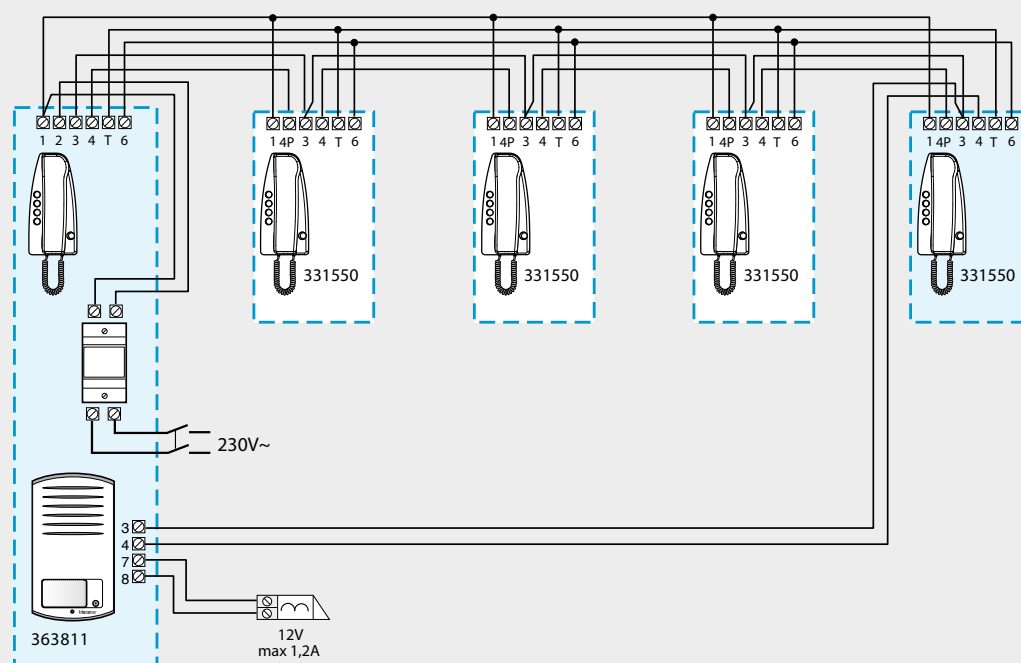



2 WIRES SYSTEM

The easiest system offer

The **2 WIRES SYSTEM** is the ideal technology for situations where time-saving and ease of installation are essential. With its non-polarized design, the 2 WIRES SYSTEM allows for seamless installation across a variety of setups, ranging from single villas to apartment complexes.

This technology is particularly suitable, for example, for:

Small and medium size system



THE VILLA

Renovations



The possibility of using existing cables makes it the ideal solution when refurbishing systems.



THE APARTMENT



Remove the old entrance panel being replaced.

Use the two cables already present to connect the new entrance panel.

In addition to the extreme simplicity, the system offers **VERY GOOD PERFORMANCE**

SYSTEM MAIN FEATURES	3900	Apartments
	3900	Apartment video entrance panels
	39	Risers with independent sound mode
	5	Handsets per apartment
	600 m	Distance between entrance panel and farthest internal unit

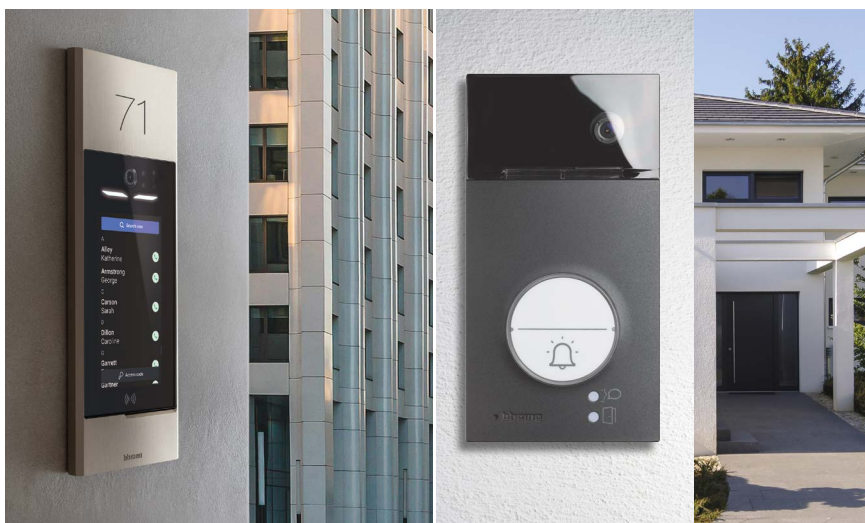
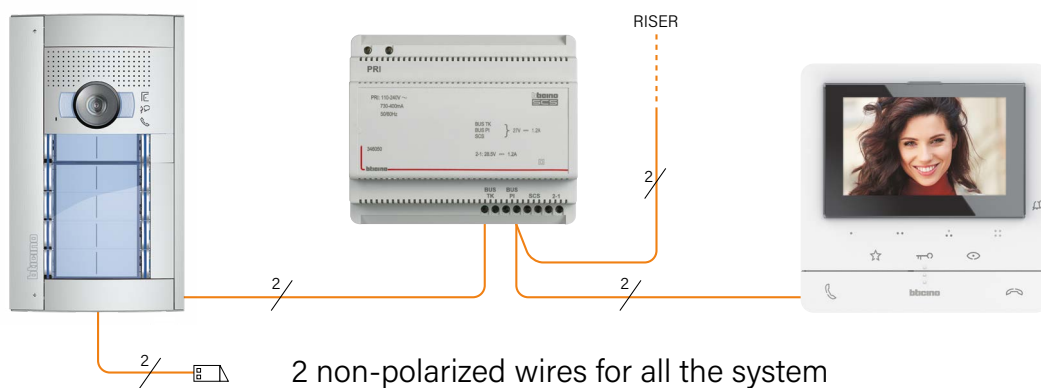

THE 2 WIRES SYSTEM

offers a wide range of entrance panels and internal units, to meet all the customer needs.

THE SYSTEM

Composition

2 WIRES

A few accessory devices are needed to make the **2-WIRE systems**, as well as the entrance panels and the internal units and/or video internal units.



- Thanks to the use of accessory devices, additional door locks can be **activated and/or lights switched on**.



Audio door entry system

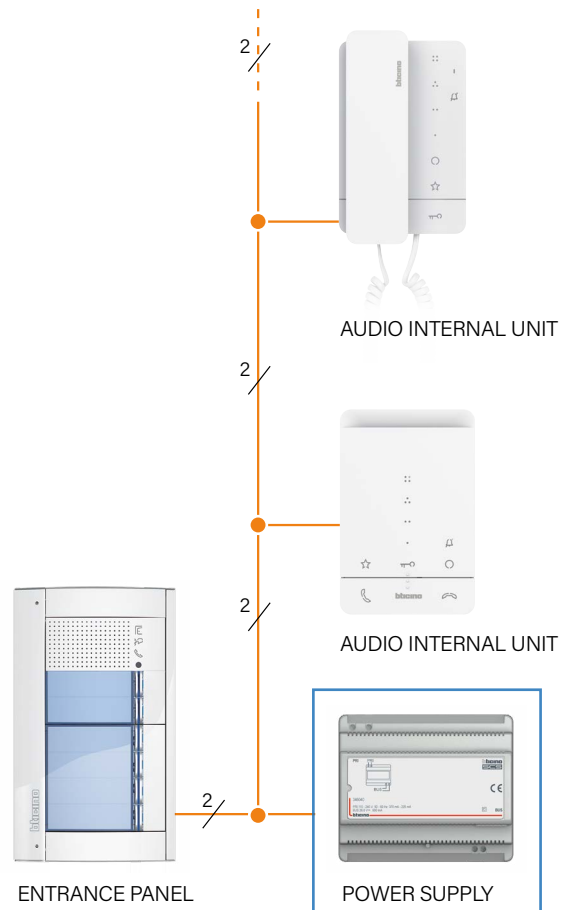

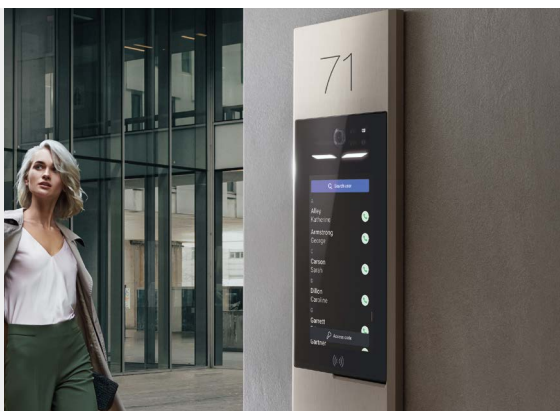

■ In apartment-block systems the switchboard can be used for **the management and centralised supervision** of the apartment-block services.

■ In systems equipped with Classe 300X, Classe 300EOS or Classe 100X connected internal units, you can **manage your door entry system calls and functions directly from your smartphone** using the dedicated Home + Security App.



Video door entry system

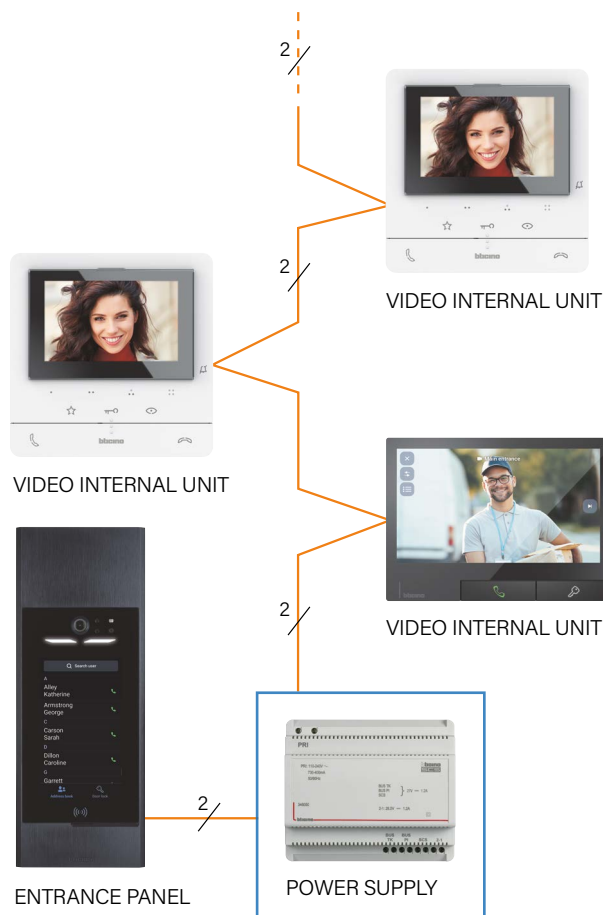

ENTRANCE PANELS RANGE

LINEA 5000

LINEA SFERA

LINEA 3000

LINEA 2000

LINEA 2000L

LINEA 100

LINEA 300





LINEA 5000

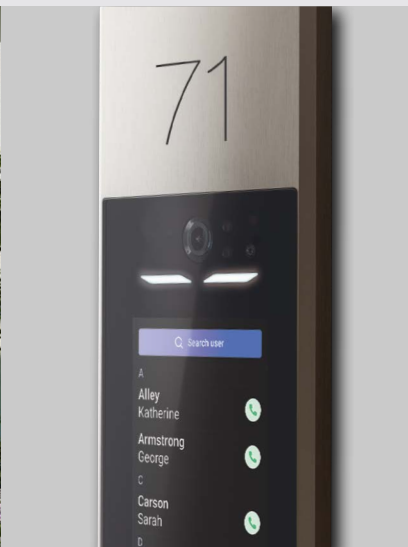

LINEA 2000L2 - L4



LINEA 3000



LINEA 2000



LINEA 300



LINEA 100



SFERA NEW



SFERA ROBUR

2 WIRES SYSTEM

Entrance panels

overview and features

	Linea 5000	Linea Sfera New	Linea Sfera Robur	Linea 3000
				
Audio		●	●	●
Colour video	●	●	●	●
Finishes / Colours	Aluminium Nickel Gold Titanium Steel	Allmetal Allwhite Allstreet	Zamak Robur	Zamak grey Zamak black
Wall mounted installation	●	●	●	●
Flush mounted installation	●	●	●	●
Pushbutton call	●	●	●	●
Digital call	●	●	●	
Wide angle camera (1)	●	●	●	●
HQ camera (2)	●	●	●	
Control speech synthesis (3)	●	●	●	
Door lock release with keypad	●	●	●	
Door lock release with key card	●	●	●	●
Rainshield	●	●	●	●
Vandal proof				
Protection index	IP65	IP54	IP54	IP54
Sturdiness index	IK08	Up to IK08	IK10	IK10
Max. number of calls	4000 with digital call	100 with pushbuttons 4000 with digital call	100 with pushbuttons 4000 with digital call	2

(1) Horizontal and vertical wide viewing field. Easy to use for children and differently-abled people.

(2) Wide angle HQ Camera 5 MP. Video signal is transmitted to internal units via PAL encoding on 2-Wires BUS SCS technology.

(3) Inductive loop and control speech synthesis. Use by people wearing hearing aids. Easy to use for visually impaired people.

	Linea 2000	Linea 2000L	Linea 300	Linea 100
				
	●	●		●
	●	●	●	
	Aluminium	Zamak black	Stainless Steel Aluminium	Stainless Steel
	●	●	●	●
		●	●	
	●	●	●	●
				●
				●
			●	
	IP54	IP44	IP54	IP44
	IK07	IK03	IK07	IK08
	2 (up to 4 calls - audio version only)	Up to 4	32 with pushbuttons 4000 with digital call	8 with pushbuttons 4000 with digital call

Linea 5000

Digital. Functional. Performing.

**Linea 5000 is the new BTicino
2 Wires Smart entrance panel.**

Ideal for the “digitalisation” of multi-family settings, it takes access to modern buildings to the next level. Featuring a large 7” touch screen display, a 5 Megapixel wide angle HQ camera, digital filters and a modern and intuitive graphic interface, it integrates perfectly with contemporary buildings, conveying a feeling of innovation and high quality.

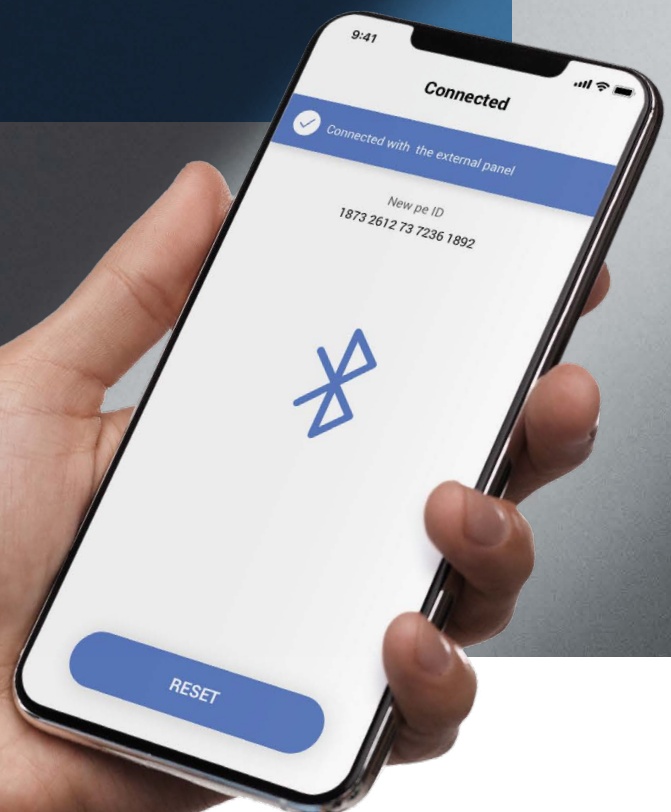



- 2
WIRES
- IP65
- IK08
- 7"
- HQ
- Bluetooth
- WI-FI
- ETH.

Access the building in different ways:

- ***

CODE
- Key Card
KEY CARD
- Smartphone
SMARTPHONE

In summary, Linea 5000 is a modern, safe and customisable digital experience, ideal for building access control and suitable for any installation situation.

2 WIRES SYSTEM

Linea 5000

5 exclusive finishes
to add value to every
entrance.

Two finishes in the catalogue.

Aluminium



Nickel

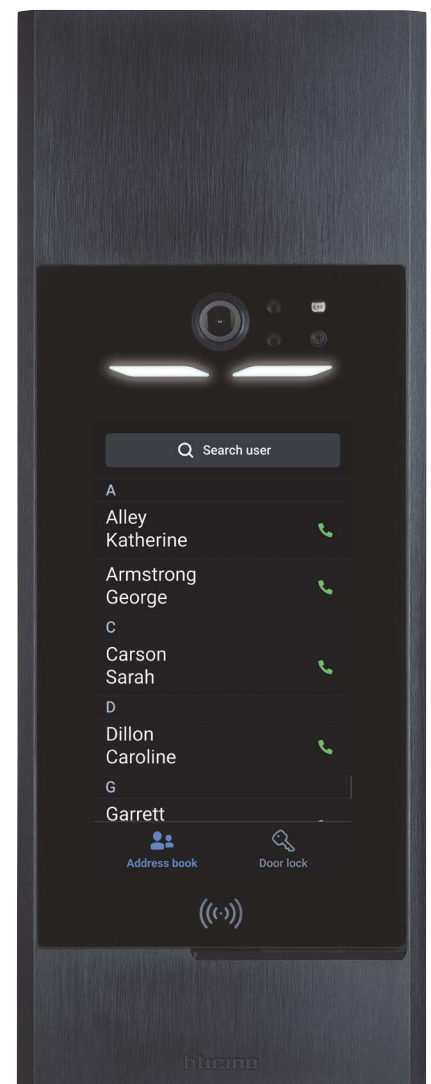

Find the solution for any room.

With 5 exclusive finishes in 60% recycled aluminium Linea 5000 can be easily adapted to all types of buildings, from contemporary of any size to classic architecture. Linea 5000 expresses robustness and high quality in every colour.

Three finishes on demand made to order or project.

Gold

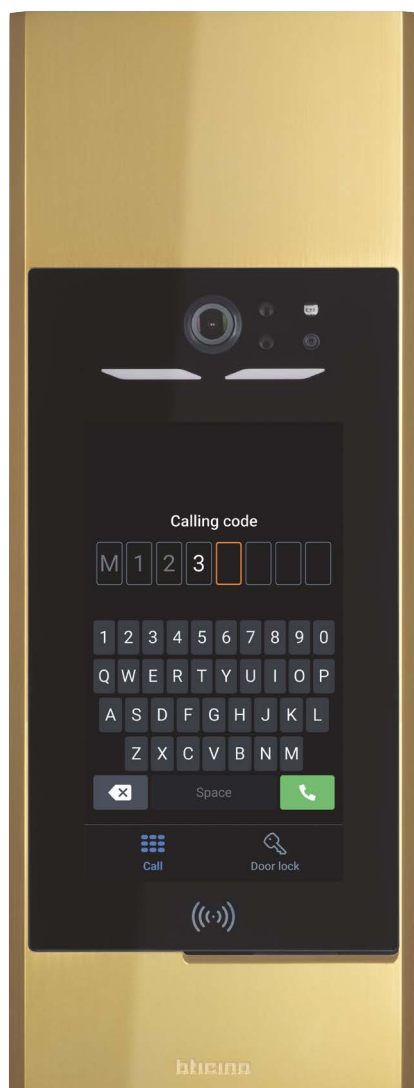

Titanium



Steel

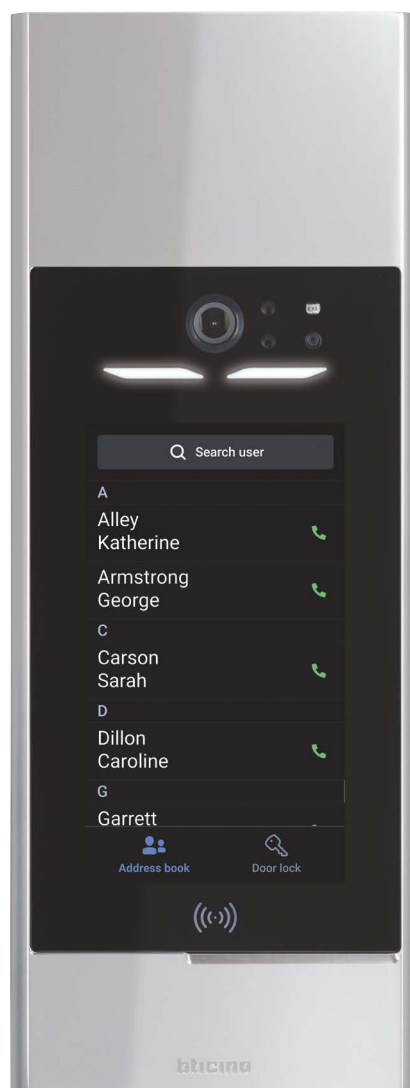

Linea 5000

BTicino 2 Wires
technology.

No changes to your
working habits.
Same installation
rules as for the 2 wires
entrance panels.



Ideal for upgrading existing 2 wires video door entry systems (e.g. systems with Sfera entrance panels or traditional brass pushbutton panels). **Bring your old system to the digital era with the new Linea 5000.** Perfectly compatible with all the devices of the BTicino 2 wires video door entry system range: Classe 300X, Classe 100 and Classe 300EOS video internal units, power supply units and system accessories.

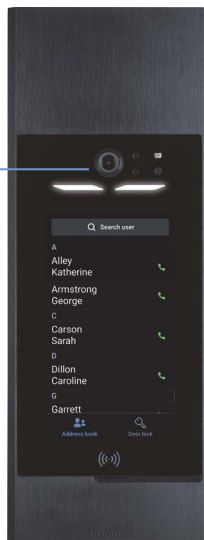

Wide angle HQ camera

Resolution: 5 Megapixel

Digital filters

Horizontal field of view: (119°)

Vertical field of view: (92°)

NOTE: video signal is transmitted to internal units via PAL encoding on 2-Wires BUS SCS technology.

Linea 5000 is suitable for all home environments.

With 2 wires technology and the possibility of customising the finish with the desired colour, logo and street number, it guarantees maximum adaptability in any living context.

Building



Apartment block



Villa



A sustainable approach



Only active when needed

The proximity and brightness sensors contribute to energy efficiency, as the screen only activates when needed, automatically and only when someone approaches.



Recycled aluminium

The fixing frames of the Linea 5000 modules and the finishing frames are made of **60% recycled aluminium**.

Linea 5000

Configure your system
with full ease.

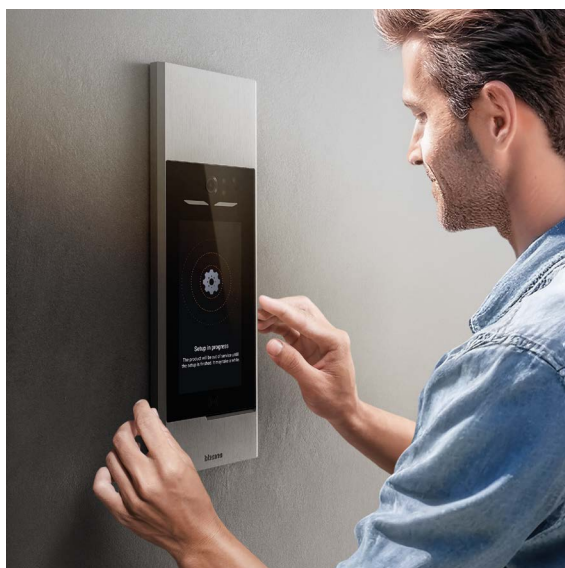
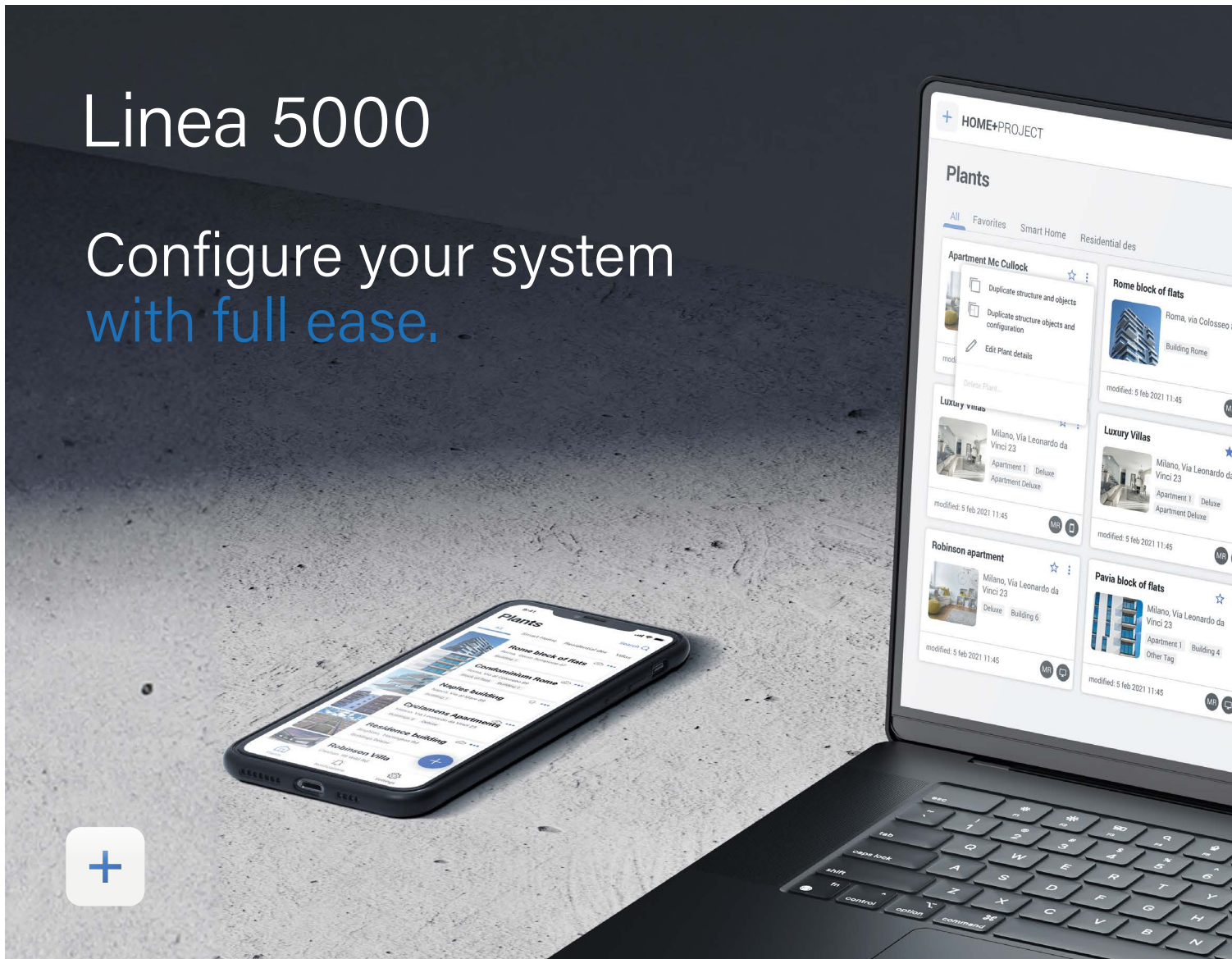

HOME + PROJECT. To digitally design, configure and customise the video door entry system

HOME + PROJECT - a new work tool for the installer. Available as a web app for Desktop PCs at <https://homeproject.legrand.com> and as a smart device mobile app for on-site configuration. Thanks to the App, creating, configuring, and fine-tuning the system has never been easier. The Web App for desktop allows you to create and configure the entire system directly from the office, with the convenience of importing files containing entire resident directories.

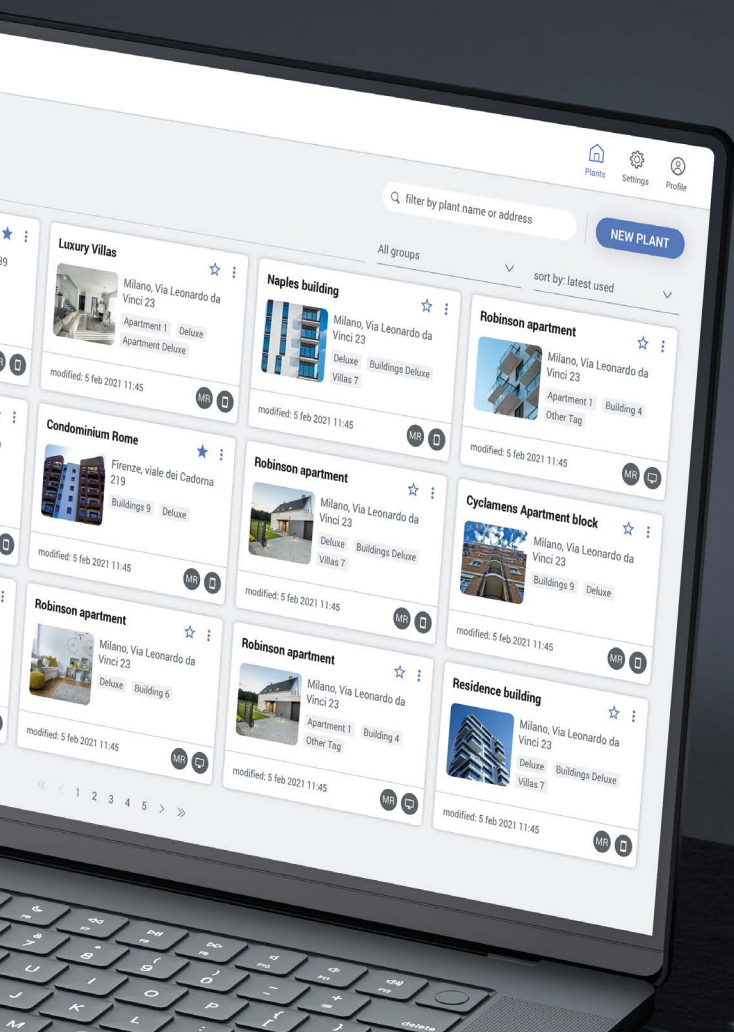

SMART REPOSITORY

HOME + PROJECT securely stores all your projects, allowing you to easily access your work from anywhere. Forget about searching for codes, local address book directories, and plant information: everything is centralized on H + P. Share your projects with colleagues or administrators quickly and securely, enhancing collaboration and increasing productivity. H + P is the ideal solution to save time and work more efficiently.

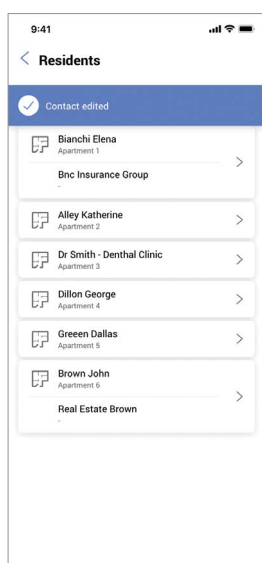
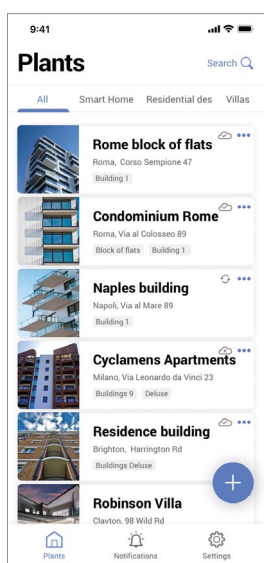

REMOTE ADDRESS BOOK EDITING

This digital tool helps simplify not only the configuration process, but also maintenance and customisation. Modify system parameters, update the address book and download the new entrance panel configuration, either remotely or directly on site via Bluetooth connection.

Linea 5000

Total adaptability.

The extensive customisation options, both physical and digital, bring unique freedom of expression. Possibility of customised finishes, with frames in assorted, logo and street number for total adaptability. All this makes Linea 5000 particularly suitable for **meeting the customisation requests from architects, design studios, real estate developers and customers.**



Physical customisation of the finishing frames

Using the specific online tool, it is possible to customise the finishing frames. Frames for customisation must be ordered using the specific custom part numbers (V/345101-02-03-04-05) - see the relevant catalogue pages.

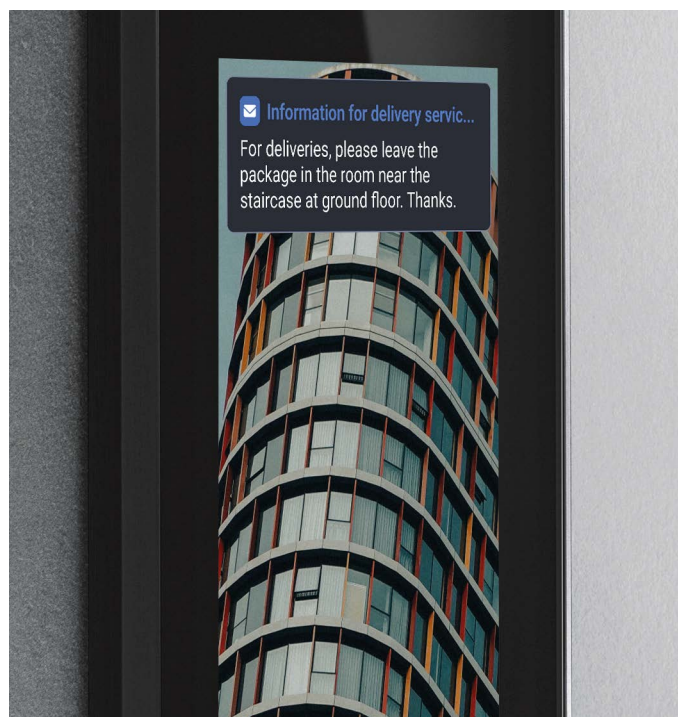

Digital customisation of the display

It is also possible to customise the display screens by changing the names of the residents in the address book, the display mode, adding a logo / address, as well as displaying messages for visitors/couriers, etc.

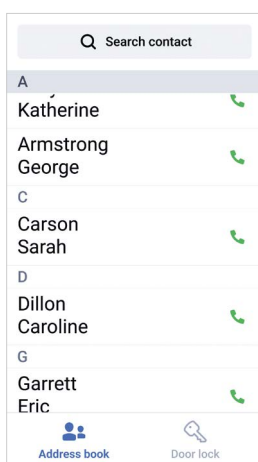

White mode: for clear and intuitive use.

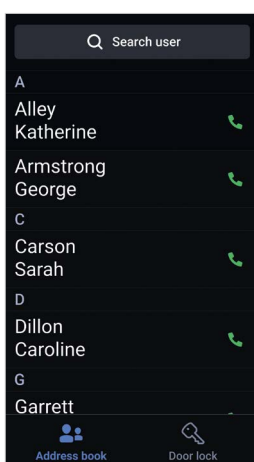

Dark mode: protect your eyes and save battery life.

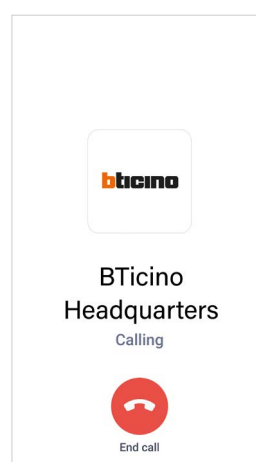

The logo of adds a very personal touch.

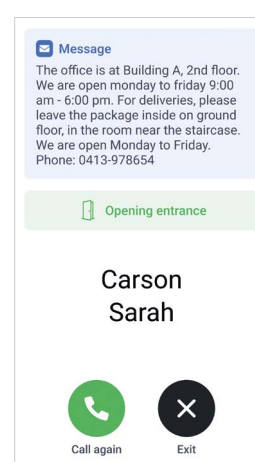

Customisable messages for Airbnb guests, couriers and visitors.

Linea 5000

Multiple call modes.
Smart call.



ADDRESS BOOK

with list of residents' names.

CALL WITH CODE (numeric or alphanumeric)

In this mode, in addition to the code you can also choose to have the address book.

APARTMENT BLOCK/RISER/FLOOR/ APARTMENT

Entering the exact address of the apartment to call in the system.

Multiple access modes. Smart access.

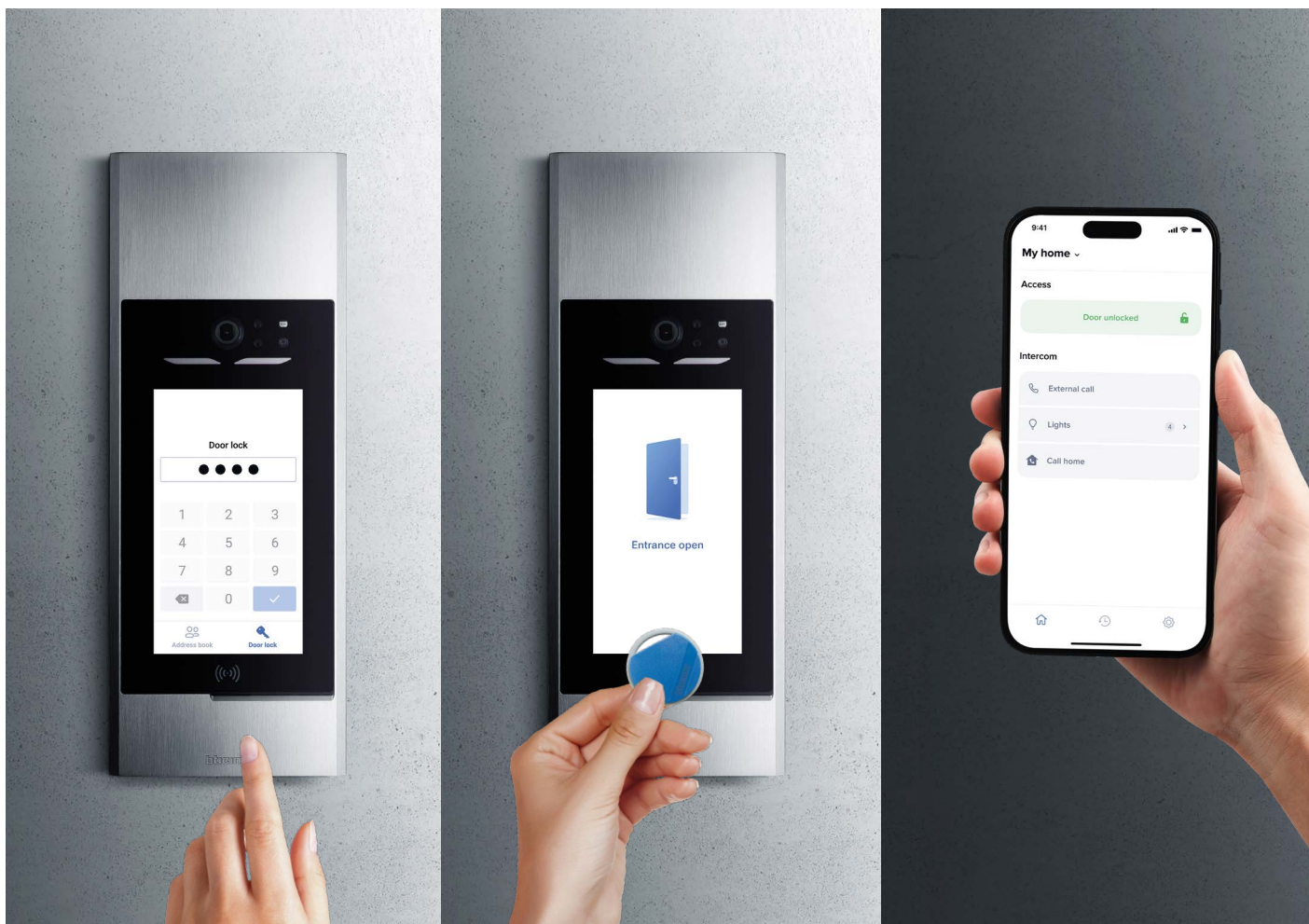

NUMERIC CODE

Pre-set.
(maximum of 5 access codes, also with date/time schedule).

RFID KEYCARD

Pre-programmed / registered.
Keycards available in different colours.



SMARTPHONE

With Home + Security App
via Bluetooth connection.



Home + Security



Linea 5000

Display module installation

The Linea 5000 entrance panels and their add-on modules can be installed flush mounted or surface/wall mounted in different combinations, as shown in the following installation examples.

Flush mounted installation of the display module



3-module finishing frames

In the catalogue



345101
Aluminium



345102
Nickel

Made to order



345103
Gold



345104
Titanium



345105
Steel

Wall or surface mounted installation of the display module



3-module wall mounted boxes with rainshield



345331
Aluminium



345332
Nickel

Linea 5000

Additional module installation

Stand alone flush mounted installation of the additional modules

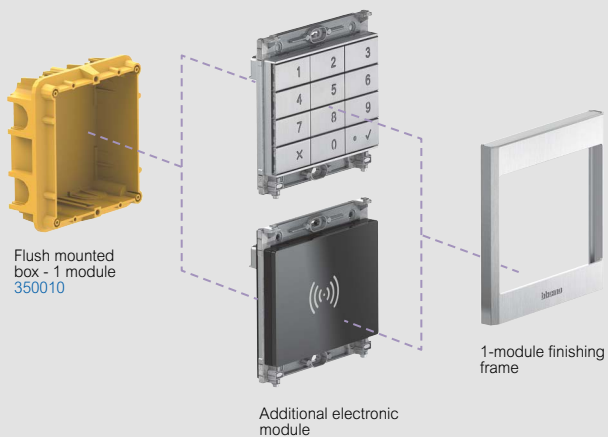

1-module finishing frames

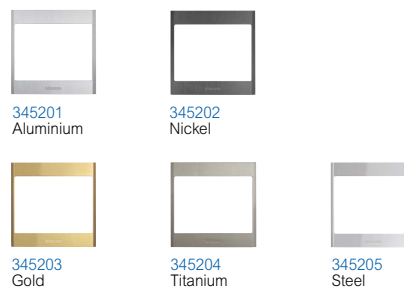

Additional modules

Keypad modules



RFID Smart Access module



Stand alone wall mounted installation of the additional modules

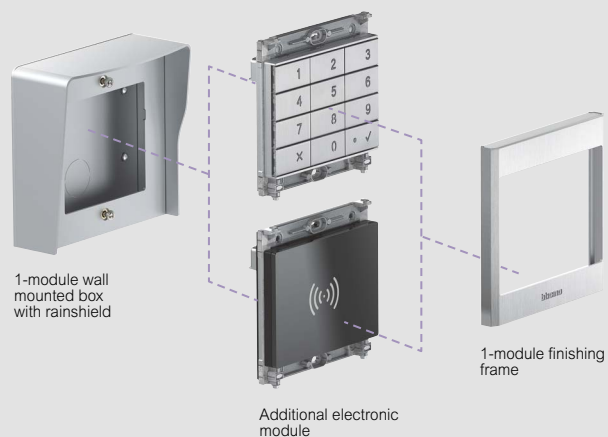

1-module wall mounted boxes with rainshield



Linea 5000

Display module + additional module installation

Flush mounted installation (3 + 1) of the display module + additional module

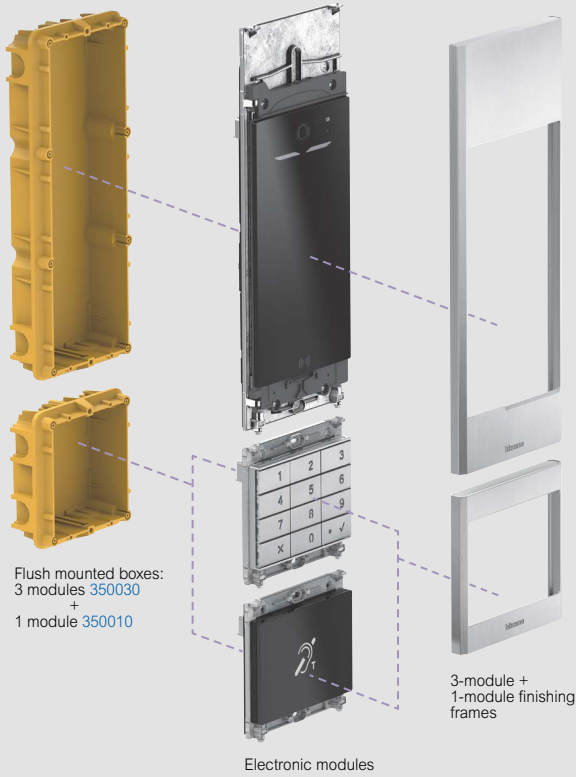

Wall mounted installation (3 + 1) of the display module + additional module

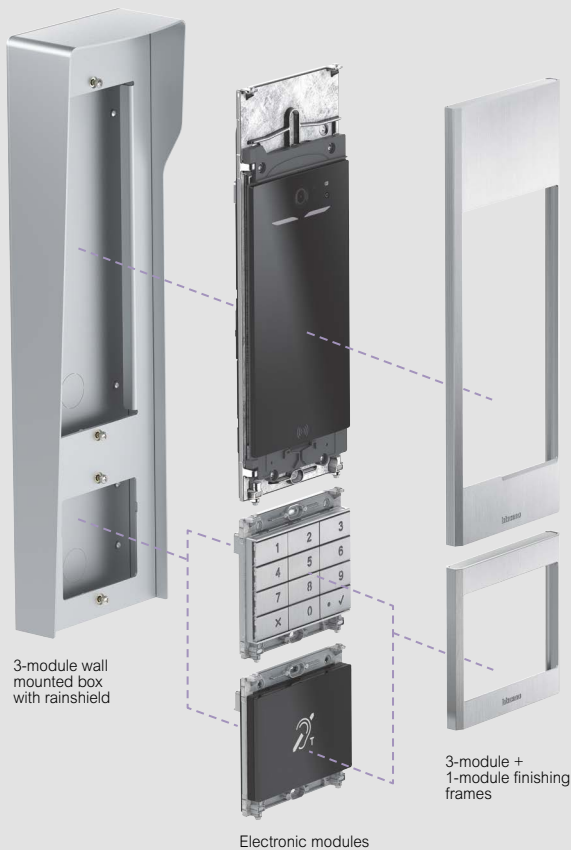

3-module finishing frames

In the catalogue



345101
Aluminium



345102
Nickel

Made to order



345103
Gold



345104
Titanium



345105
Steel

1-module finishing frames



345201
Aluminium



345202
Nickel



345203
Gold



345204
Titanium



345205
Steel

Additional modules

Keypad modules



345500
Aluminium



345510
Nickel

Inductive loop module



345530

Wall mounted boxes with rainshield (3+ 1) modules



345341
Aluminium



345342
Nickel

Linea 5000 - Catalogue

Display module and 3-module finishing frames



Item	Display module
345000	<p>7" vertical display module with wide-angle HQ camera (5 MP).</p> <p>Display and audio/video module to be combined with one of the 5 frames in different finishes for the creation of 2 wires systems. Equipped with an HQ camera with wide-angle field of view (119° horizontal - 92° vertical), white LEDs for lighting and twilight sensor for night vision. High-resolution 7" touch screen display with shatter-proof glass (IK08), anti-fingerprint and proximity sensor for automatic switching on. With a digital microphone and echo eliminator for optimal sound performance. The flexible and user-friendly graphic interface is adaptable to any type of apartment block and allows a choice of 3 different call modes: address book call (list of residents' names), numeric or alphanumeric code call and block-staircase-floor-apartment logic code call. The direct call to the guard station and the customisation of the homepage logos also make it suitable for solutions with concierge or for commercial establishments. With advanced features such as voice feedback, automatic theme change (light/dark), customisation of welcome messages or instructions and temporary access code forwarding, it is suitable for residents and visitors of all ages and abilities. It also supports different modes for accessing the building: lock release with display code, RFID badge or Bluetooth via the Home + Security App, the resident's app. Programming and configuration requires the use of Home + Project (App or PC), the digital tool for the professional. Using this tool, it is possible to complete the entire configuration at the office, share it with other professionals and upload it to the display module via Bluetooth. Changes to residents' names and access codes are quick and smart, either on-site (via Bluetooth) or remotely (if the module has an active WiFi or Ethernet connection). Installation with 3-module flush mounted box 350030 or with wall mounted box 345331 or 345332. The book-like opening of the module allows for easy wiring. It allows the activation of an electrical door lock directly connected to clamps S+ and S- (18 V 4 A impulsive - 250 mA holding current 30 Ohm max) and of connecting a local door lock release pushbutton on clamps PL.</p>

Item	Finishing frames - in the catalogue
345101	<p>3-module frame – Aluminum finish 3-module frame in aluminum finish for display module 345000</p>
345102	<p>3-module frame – Nickel finish As 345101 but with Nickel finish</p>
Finishing frames - made to order	
345103	<p>3-module frame – Gold finish 3-module frame in Gold finish for display module 345000</p>
345104	<p>3-module frame – Titanium finish As 345103 but with Titanium finish</p>
345105	<p>3-module frame – Steel finish As 345103 but with Steel finish</p>

2 WIRES SYSTEM

Linea 5000 - Catalogue

Additional modules and 1-module finishing frames



345500



345510



345520



345530



345201



345202



345203



345204



345205

Item **Keypad modules**

- 345500 Additional keypad module in Aluminum finish**
Keypad module with aluminium key finish for door lock opening in 2-wire systems where there is at least one Linea 5000 display module (345000). The keypad module is fitted with relay contacts (C – NO - NC) and clamps (CP - P1) for the connection of a local door release pushbutton and can be programmed using the Home + Project app. It has a programming reset pushbutton, LEDS for the visual notification of the access status and night backlighting. The device, to be completed with an appropriate frame, can be used stand-alone or combined with a display module in a 3+1 composition. To be installed in 1-module flush mounted box 350010, in wall mounted box 345311 or with dedicated accessory 345341 for 3+1 composition.

- 345510 Additional keypad module in Nickel finish**
As 345500 but with NICKEL finish

1-module finishing frames

- 345201 1-module frame – Aluminum finish**
1-module frame in aluminium finish for electronic modules 345500 - 345510 - 345520 - 345530.
- 345202 1-module frame – Nickel finish**
As 345201 but with Nickel finish
- 345203 1-module frame – Gold finish**
As 345201 but with Gold finish
- 345204 1-module frame – Titanium finish**
As 345201 but with Titanium finish
- 345205 1-module frame – Steel finish**
As 345201 but with Steel finish

Item **RFID Smart access module**

- 345520 Additional RFID Smart access module**
RFID/bluetooth smart access module for door lock opening in 2-wire systems where there is at least one Linea 5000 display module (345000), using the badge or using the Home + Security App via bluetooth. The smart access module is fitted with relay contacts (C – NO - NC) and clamps (CP - P1) for the connection of a local door release pushbutton and can be programmed using the Home + Project app. It has a programming reset pushbutton, LEDS for the visual notification of the access status and night backlighting. The device, to be completed with an appropriate finishing frame, can be installed in 1-module flush mounted box 350010 or in wall mounted box 345311 or 345312.

Inductive loop module

- 345530 Additional Inductive loop module**
Inductive loop module to be used in conjunction with the display module Linea 5000 (345000). It allows people wearing hearing aids fitted with (T) selector to use audio door entry communication. In this mode, the hearing aid receives the audio signal directly from the amplification system, bypassing the microphone of the hearing aid itself, improving audio quality and reducing background noise. It is connected to the display module using the appropriate multicable supplied. To be completed with the appropriate finishing frame (available in 5 finishes) The device CANNOT be used stand-alone but only as additional module in conjunction with the Linea 5000 display (345000). To be installed in 1-module flush mounted box 350010 or with the dedicated accessory 345341 or 345342 for 3+1 composition.

Linea 5000 - Catalogue

Accessories

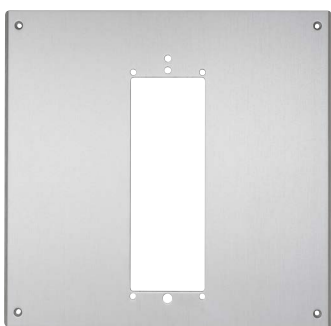

345111

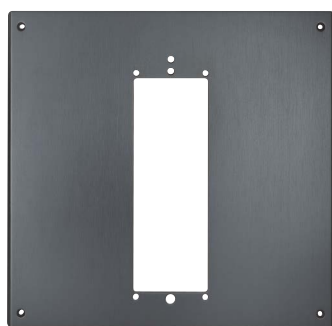

345112

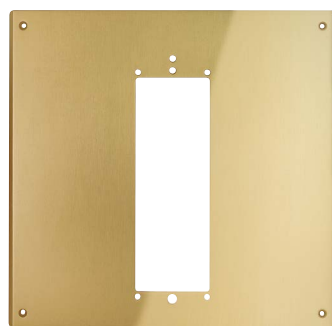

345113



345121



345122



350010



350030



345311



345312



345331



345332



345341



345342

Item **XL accessory plates**

345111 XL cover plate– Aluminium finish
XL accessory plate in aluminium finish used for the installation of Linea 5000 entrance panels in place of existing multi-pushbutton panels. The XL dimensions allow for easy replacement by covering the hole left by the existing plate, optimised for three 3-module boxes side by side.

345112 XL cover plate– Nickel finish
As 345111 but with Nickel finish

345113 As 345111 but with Gold finish

Accessory plates compatible with LINEA 300

345121 Accessory plate compatible with Linea 300 – Aluminium finish
Accessory plate in Aluminium finish compatible with the Linea 300 pushbutton panels. Used for the installation of Linea 5000 entrance panels in replacement of existing Linea 300 pushbutton panels. The specific dimensions allow easy installation of the Linea 5000 digital display module to replace an existing Linea 300 pushbutton panel.

345122 Accessory plate compatible with Linea 300 – Nickel finish
As 345121 but with Nickel finish

Item **Flush mounted boxes**

350010 Flush mounted box - 1 module
Plastic flush mounted box – 1 module

350030 Flush mounted box – 3 modules
Plastic flush mounted box – 3 modules

Wall mounted box with rainshield

345311 Wall mounted box – 1 module- Aluminium finish
Wall mounted box with integrated rainshield – 1 module – Aluminium finish.

345312 Wall mounted box – 1 module - Nickel finish
As 345311 but with Nickel finish

345331 Wall mounted box – 3 modules - Aluminium finish
Wall mounted box with integrated rainshield – 3 modules – Aluminium finish.

345332 Wall mounted box – 3 modules - Nickel finish
As 345331 but with Nickel finish

345341 Wall mounted box – 4 modules - Aluminium finish
Wall mounted box with integrated rainshield – (3+1) modules – Aluminium finish.

345342 Wall mounted box – 4 modules - Nickel finish
As 345341 but with Nickel finish

2 WIRES SYSTEM

Linea 5000 - Catalogue

Customisable finishing frames

Spare parts



V/345101

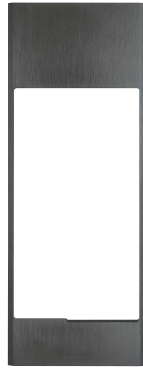

V/345102



V/345103



SP115



SP116



V/345104



V/345105

Item	Customisable 3-module finishing frames
V/345101	Customisable 3-module frame - Aluminum finish 3-module frame that can be customised with dedicated graphics and logos on request. Aluminium finish. Frame to complete the 345000 display module.
V/345102	Customisable 3-module frame – Nickel finish As V/345101 but with Nickel finish
V/345103	Customisable 3-module frame – Gold finish As V/345101 but with Gold finish
V/345104	Customisable 3-module frame – Titanium finish As V/345101 but with Titanium finish
V/345105	Customisable 3-module frame – Steel finish As V/345101 but with Steel finish

Item	3-module support frame
SP115	3-module support frame Spare part – 3-module aluminium support frame
SP116	1-module support frame Spare part – 1-module aluminium support frame



For the customisation of custom finishing frames with specific logos, text and graphics, use the online tool accessible through the **YouDiagram** software, the **video door entry system configurator** and the www.bticino.com portal.

Linea 5000 - Catalogue

Smart Access RFID programmable keycards



348200 348201 348202 348203
 348204 348205 348206 3547

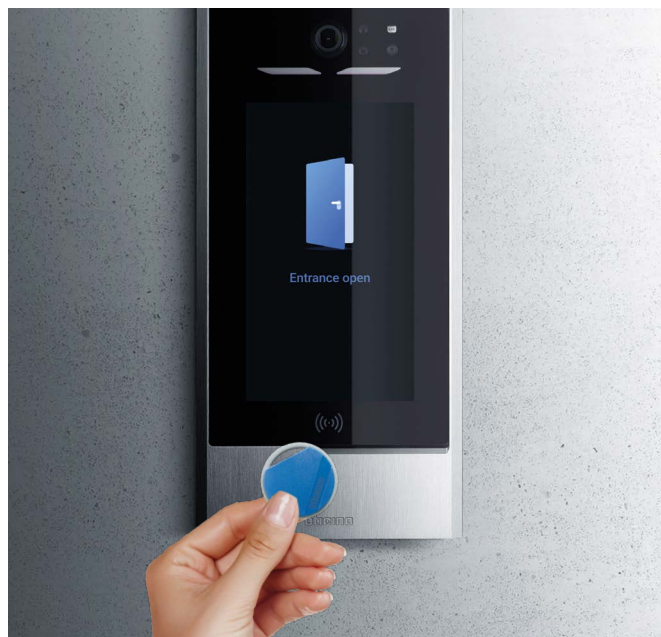

Item	RFID programmable keycards
348200	Door lock release keycard - black
348201	Door lock release keycard - red
348202	Door lock release keycard - green
348203	Door lock release keycard - blue
348204	Door lock release keycard - orange
348205	Door lock release keycard - grey
348206	Door lock release keycard - yellow
3547	Door lock release customisable card (ISO 50 x 80 mm)



2 WIRES SYSTEM

Entrance panel

SFERA

Two styles One electronic heart

2-wires simplicity, maximum performance

Exceptional audio and video performance as well as fast and simple installation can be achieved with 2-wires technology.

- New HQ Camera (5 MP)
- Up to 4000 dwellings
- 20 handsets per dwelling
- Up to 96 video entrance panels
- Operable range of 600 m between entrance panel and internal unit



SFERA ROBUR



SFERA NEW



SFERA

AUDIO-VIDEO
MODULE WITH 5 MP
HIGH-QUALITY
CAMERA

351500

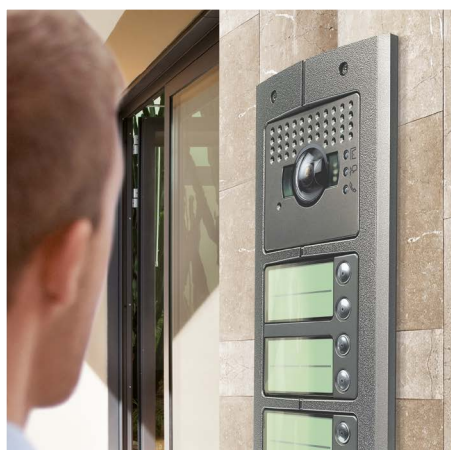

2 WIRES SYSTEM

SFERA

Audio video module with 5 MP HQ camera 351500

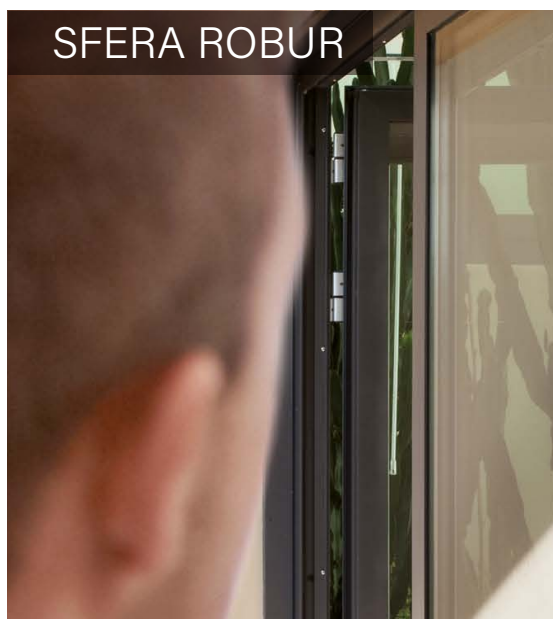
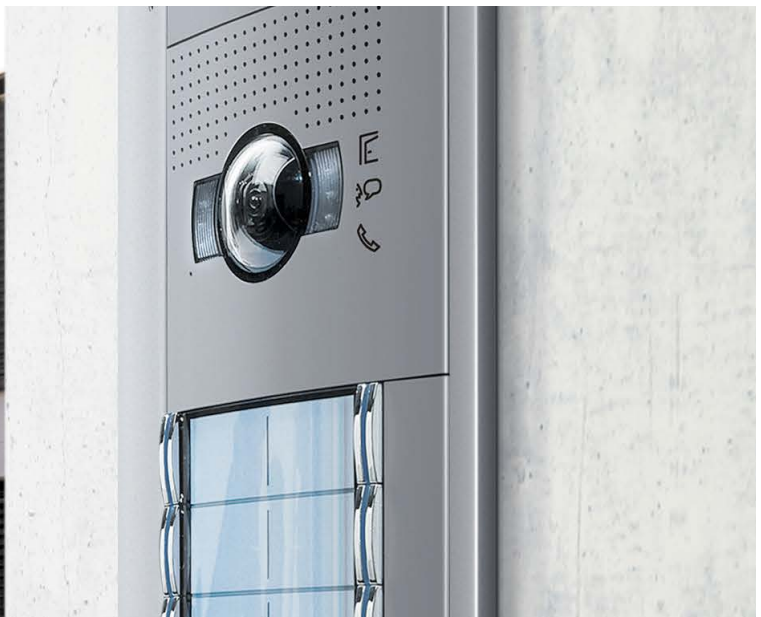

2
WIRES

HQ



351500 - front



351500 - rear

Comparison table of new items and dismissed items.



Codes of existing front covers

NEW A/V Module.



351500

Allmetal finishing front covers



351301 351311 351321

Allstreet finishing front covers

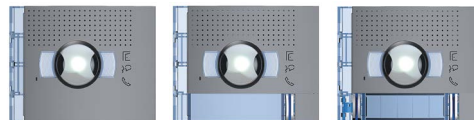

351303 351313 351323

Allwhite finishing front covers



351302 351312 351322

Robur finishing front covers



351305 351315 351325



Codes being discontinued

A/V module.



351200

Sfera New - Robur front covers



351201 351211 351221 351202 351212 351222



351203 351213 351223 351205 351215 351225

Wide angle N/D camera module



352400

Sfera New - Robur front covers



352401 352402 352403 352405

A/V module. Wide angle camera



351300













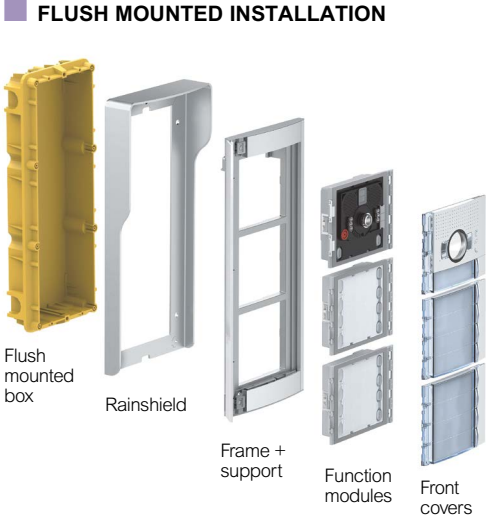





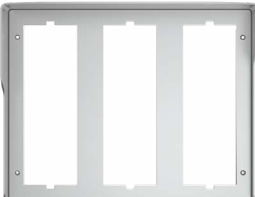

Sfera New - Robur front covers

They are used for the new module 351500

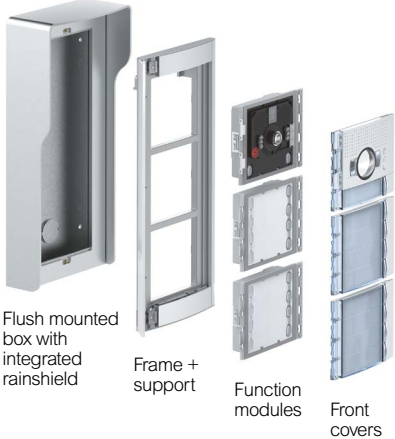



































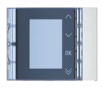

2 WIRES SYSTEM

SFERA

Sfera New pushbutton panels - selection table

FINISH	TYPE OF INSTALLATION	FLUSH MOUNTED BOXES	RAINSHIELD (OPTIONAL) ^{1, 2}	FRAME ²
<p>CHOOSE THE FINISHING</p> <p>Replace the dots in the item code with 1, 2, or 3 to select the desired finish</p> <p>1 ALLMETAL</p>  <p>2 ALLWHITE</p>  <p>3 ALLSTREET</p> 	<p>FLUSH MOUNTED INSTALLATION</p>  <p>Flush mounted box</p> <p>Rainshield</p> <p>Frame + support</p> <p>Function modules</p> <p>Front covers</p>	<p>350010 1 module</p>  <p>350020 2 modules</p>  <p>350030 3 modules</p> 	<p>35051... 1 module</p>  <p>35054... 4 modules</p>  <p>35052... 2 modules</p>  <p>35056... 6 modules</p>  <p>35053... 3 modules</p>  <p>35059... 9 modules</p> 	<p>35021... 1 modules</p>  <p>35022... 2 modules</p>  <p>35023... 3 modules</p> 
	<p>WALL MOUNTED INSTALLATION</p>  <p>Flush mounted box with integrated rainshield</p> <p>Frame + support</p> <p>Function modules</p> <p>Front covers</p>	<p>WALL MOUNTED BOX²</p> <p>35061... 1 module</p>  <p>35062... 2 modules</p>  <p>35063... 3 modules</p>  <p>35064... 4 modules</p>  <p>35066... 6 modules</p>  <p>35069... 9 modules</p> 		











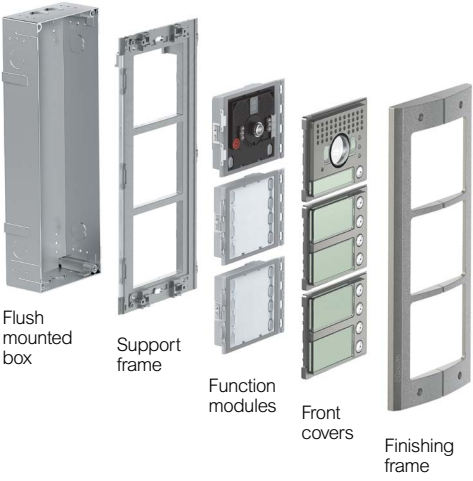





1 : Only for flush mounted installation 2 : To select the desired finishing, see 'CHOOSE THE FINISHING', on the top left

ELECTRONIC MODULES		FRONT COVERS ²					
		Audio front covers					
SPEAKER MODULES	 <p>351000 Basic speaker (only audio systems)</p>	 <p>35100... Basic speaker</p>	 <p>35101... Basic speaker 1 pushbutton</p>	 <p>35102... Basic speaker 2 pushbuttons</p>	 <p>35104... Basic speaker 2 pushbuttons on double row</p>	 <p>35108... Basic speaker 4 pushbuttons on double row</p>	
	 <p>351100 Speaker</p>	 <p>35110... Speaker</p>	 <p>35111... Speaker 1 pushbutton</p>	 <p>35112... Speaker 2 pushbuttons</p>	 <p>35114... Speaker 2 pushbuttons on double row</p>	 <p>35118... Speaker 4 pushbuttons on double row</p>	
PUSHBUTTON MODULES	 <p>352000 4 pushbuttons on single row</p>	 <p>35203... 3 pushbuttons</p>	 <p>35204... 4 pushbuttons</p>	 <p>352011 1 pushbutton</p>	 <p>352021 2 pushbuttons</p>		
	 <p>352100 8 pushbuttons on double row</p>	 <p>35216... 6 pushbuttons on double row</p>	 <p>35218... 8 pushbuttons on double row</p>	 <p>352121 2 pushbuttons on double row</p>	 <p>352141 4 pushbuttons on double row</p>		
AUDIO VIDEO MODULE	 <p>351500 Audio / video with High-Quality camera 5 MP</p>	<p style="text-align: center;">Video front covers</p>				 <p>354000 Cable for connecting multiple pushbutton modules L = 470 millimetres</p>	
		 <p>35130... Audio / video wide angle</p>	 <p>35131... Audio / video wide angle 1 pushbutton</p>	 <p>35132... Audio / video wide angle 2 pushbuttons on double row</p>			
VARIOUS MODULES	<p style="text-align: center;">Various front covers</p>						
	 <p>352200 Nameplate</p>	 <p>35220... Nameplate</p>					
	 <p>352500 Display</p>	 <p>35250... Display</p>					
	 <p>352700 Inductive loop and control speech synthesis</p>	 <p>35270... Inductive loop and control speech synthesis</p>				 <p>35230... blanking module</p>	
	 <p>353200 Key card reader</p>	 <p>35320... Key card reader</p>					
 <p>353000 Keypad</p>	 <p>35300... Numeric keypad</p>	 <p>353011 Alphanumeric keypad</p>					
<p style="text-align: center;">CHOOSE THE FINISHING Replace the dots in the item code with 1, 2, or 3 to select the desired finish.</p>							

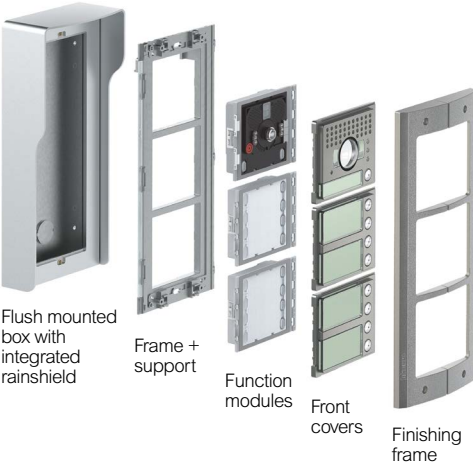































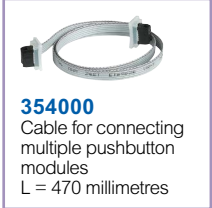

2 WIRES SYSTEM

SFERA

Sfera Robur pushbutton panels - selection table

FINISH	TYPE OF INSTALLATION	FLUSH MOUNTED BOXES	SUPPORT FRAME	FINISHING FRAME
<p>(ROBUR)</p> 	<p>FLUSH MOUNTED INSTALLATION</p>  <p>Flush mounted box</p> <p>Support frame</p> <p>Function modules</p> <p>Front covers</p> <p>Finishing frame</p>	<p>FLUSH MOUNTED BOXES</p>  <p>350110 1 module</p>  <p>350120 2 modules</p>  <p>350130 3 modules</p>	<p>SUPPORT FRAME</p>  <p>350315 1 module</p>  <p>350325 2 modules</p>  <p>350335 3 modules</p>	<p>FINISHING FRAME</p>  <p>350415 1 module</p>  <p>350425 2 modules</p>  <p>350435 3 modules</p>
	<p>WALL MOUNTED INSTALLATION</p>  <p>Flush mounted box with integrated rainshield</p> <p>Frame + support</p> <p>Function modules</p> <p>Front covers</p> <p>Finishing frame</p>	<p>WALL MOUNTED BOX ²</p>  <p>35061... 1 module</p>  <p>35064... 4 modules</p>  <p>35062... 2 modules</p>  <p>35066... 6 modules</p>  <p>35063... 3 modules</p>  <p>35069... 9 modules</p>		

1 : To select the desired finishing, see SFERA NEW 'CHOOSE THE FINISHING'.

		ELECTRONIC MODULES	FRONT COVERS									
		Audio front covers										
SPEAKER MODULES		351000 Basic speaker (only audio systems)		351005 Basic speaker		351015 Basic speaker 1 pushbutton		351025 Basic speaker 2 pushbuttons		351045 Basic speaker 2 pushbuttons on double row		351085 Basic speaker 4 pushbuttons on double row
		351100 Speaker		351105 Speaker		351115 Speaker 1 pushbutton		351125 Speaker 2 pushbuttons		351145 Speaker 2 pushbuttons on double row		351185 Speaker 4 pushbuttons on double row
PUSHBUTTON MODULES		352000 4 pushbuttons on single row		352035 3 pushbuttons		352045 4 pushbuttons						
		352100 8 pushbuttons on double row		352165 6 pushbuttons on double row		352185 8 pushbuttons on double row						
AUDIO VIDEO MODULE		351500 Audio / video with High-Quality camera 5 MP		351305 Audio / video wide angle		351315 Audio / video wide angle 1 pushbutton		351325 Audio / video wide angle 2 pushbuttons on double row				
			 <p>354000 Cable for connecting multiple pushbutton modules L = 470 millimetres</p>									
		Various front covers										
VARIOUS MODULES		352200 Nameplate		352205 Nameplate								
		352500 Display		352505 Display								
		352700 Inductive loop and control speech synthesis		352705 Inductive loop and control speech synthesis								
		353200 Key card reader		353205 Key card reader								
		353000 Keypad		353005 Keypad								
		 <p>352305 blanking module</p>										

2 WIRES SYSTEM

SFERA

Sfera pushbutton panels - electronic modules



351000



351100



351500



352000



352100



352200

Item	Electronic modules
351000	BASIC speaker module for the creation of 2 WIRES audio systems. Fitted with speaker and microphone volume adjustment. It manages up to 100 pushbutton calls using additional double row pushbuttons. It allows the activation of an electrical door lock directly connected to clamps S+ and S- (18 V 4 A impulsive - 250 mA holding current 30 Ohm max) and of connecting a local door lock release pushbutton on clamps PL. To be completed with surround plate. The device must be physically configured.
351100	speaker module for the creation of 2 WIRES audio systems. Fitted with speaker and microphone volume adjustment. It can manage up to 100 pushbutton calls using the additional double row pushbutton modules. It allows the activation of an electrical door lock directly connected to clamps S+ and S- (18 V 4 A impulsive - 250 mA holding current 30 Ohm max) and of connecting a local door lock release pushbutton on clamps PL. Preset for additional power supply. Fitted with front LEDs for the notification of the operating status: door lock release, active communication, forwarded call, and busy system. Integrated optic sensor for the switching on of the night backlighting. To be completed with surround plate. The device can be configured either physically or using the PC and the specific software. - it can be downloaded free of charge from the website www.bticino.com
351500	Sfera audio/video module for the creation of 2 WIRES colour video systems. Fitted with 5 MP wide angle High-Quality camera with digital filters and white LEDs for the lighting of the shooting field. The HQ digital video signal is transmitted to internal units via PAL encoding on 2 Wires BUS SCS technology. Speaker and microphone volume adjustments. It can manage up to 98 pushbutton calls using the additional double row pushbutton modules. Horizontal angle of vision (119°), vertical angle of vision (92°). It allows the activation of an electrical door lock directly connected to clamps S+ and S- (18 V 4 A impulsive - 250 mA holding current 30 Ohm max) and the connection of a local door lock release pushbutton on clamps PL. Preset for additional power supply. Fitted with front LEDs for the notification of the operating status: door lock release, active communication, forwarded call, and busy system. Integrated optic sensor for the switching on of the night backlighting. To be completed with surround plate. The device must be configured physically or using a PC with the specific software, which can be downloaded free of charge from www.bticino.com

Item	Electronic modules
352000	additional 4-pushbutton modules arranged on single column. To be used with speaker modules 351000 - 351100 and with video module 351500. Connection using the appropriate multicable supplied. Backlighting of nameplates controlled by the speaker module or the audio/video module connected. To be completed with surround plate.
352100	additional 8-pushbutton modules arranged on double column. To be used with speaker modules 351000 - 351100 and with audio video module 351500. Connection using the appropriate multicable supplied. Backlighting of nameplates controlled by the speaker module or the audio/video module connected. To be completed with surround plate.
352200	nameplate module normally used for displaying the house number or other notifications (e.g. legend for calls using digital pushbutton panels, opening/closing times, etc.). Connection using the appropriate multicable supplied. Night backlighting controlled by the speaker module or the audio/video module connected. To be completed with surround plate.

SFERA

Sfera pushbutton panels - electronic modules



Electronic modules

- 352500 graphic display module** to be used with speaker module **351100** or with audio/video module **351500** (connection using the multicable supplied). It can operate in two modes: call from address book or digital call. The call from the address book gives the possibility of sending the call by scrolling on the display the names associated to the residents. It is possible to store up to 4000 residents names. Using the keypad module item **353000** it is also possible to directly call the apartment by entering the number corresponding to the resident. The digital call is also performed using the keypad module item **353000** by entering the numerical code. It is recommended that one or more nameplate modules, item **352200**, are installed at the side of the pushbutton panel to display the correspondence between the numerical codes and the names of the users. It is possible to program the names in the address book in two different ways: manual inclusion using the pushbuttons of the display module or inclusion using a PC with the specific software, which can be downloaded free of charge from www.bticino.com, by downloading the file to the display module (RECOMMENDED). System power supply cuts DO NOT cause the loss of memory data. To be completed with finishing front cover.
- 352700 module for inductive loop and control speech synthesis** to be used with speaker module **351100** or with audio video module **351500**. It allows use by hearing (equipped with T-selector) or visually impaired individuals, thanks to the synthesis of voice messages on the connection status (call in progress, end of call, no answer, busy, door open). It is connected to the speaker module using the appropriate multicable supplied. To be completed with surround plate. The device can be configured either physically or using the PC and the specific software. - it can be downloaded free of charge from the website www.bticino.com

Electronic modules

- 353000 Keypad module** for door lock release or for digital call to the apartment (in combination with display module). It's fitted with relay contacts (C – NO - NC) and clamps (CP - P1 - P2) for the connection of a local door release pushbutton. The numerical code for the opening of the door lock can be programmed using the keypad itself, or using a PC after downloading the module programming file. It also has a programming reset pushbutton and LEDS for the visual notification of the access status. Night backlighting with LEDs. To be completed with surround plate. It is connected to the other modules using the appropriate multicable supplied. The device may also be used as a stand alone unit with independent power supply and operation, only for door lock release. Configuration performed using physical configurators, or a PC with the specific software, which can be downloaded free of charge from www.bticino.com
- 353200 RFID key card reader module** for the release of the door lock by swiping the key card. It manages up to 20000 key cards. It's fitted with relay contacts (C – NO - NC) and clamps (CP - P1 - P2) for the connection of a local door release pushbutton. The key card for the release of the door lock can be programmed from the module itself, or using a PC after downloading the module programming file. It also has a programming reset pushbutton and LEDS for the visual notification of the access status. Night backlighting with LEDs. To be completed with surround plate. It is connected to the other modules using the appropriate multicable supplied. The device may also be used as a stand alone unit with independent power supply and operation. Configuration performed using physical configurators, or a PC with the specific software, which can be downloaded free of charge from www.bticino.com
- 346993 The key expansion module** gives the possibility of connecting the call key to the SFERA speaker modules (items **351000**; **351100**; **351500**). Each module can manage up to 8 call keys It is possible to connect several key expansion modules (max 96 call keys for each entrance panel)
- Door lock release transponder and card for Sfera entrance panels and programmer**

 - 348200** door lock release keycard - black
 - 348201** door lock release keycard - red
 - 348202** door lock release keycard - green
 - 348203** door lock release keycard - blue
 - 348204** door lock release keycard - orange
 - 348205** door lock release keycard - grey
 - 348206** door lock release keycard - yellow
 - 3547** door lock release customisable keycard (ISO 50 x 80 mm)
 - 348402** tabletop key card programmer

2 WIRES SYSTEM

Entrance panel

LINEA 3000

LINEA 3000

One entrance panel for every need



LINEA 3000 can be configured both for 1 and 2 family house



ONE FAMILY HOUSE

- Write the name on the one family nameplate label (supplied with the product).
- Set the internal micro-switch on position 1.

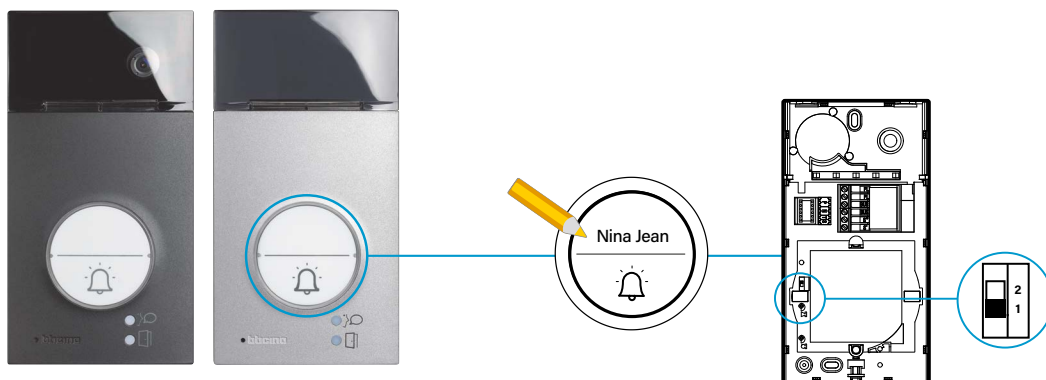

TWO FAMILY HOUSE

- Replace the nameplate label with the two family one (supplied with the product).
- Write the names on the two family nameplate label
- Set the internal micro-switch on position 2.

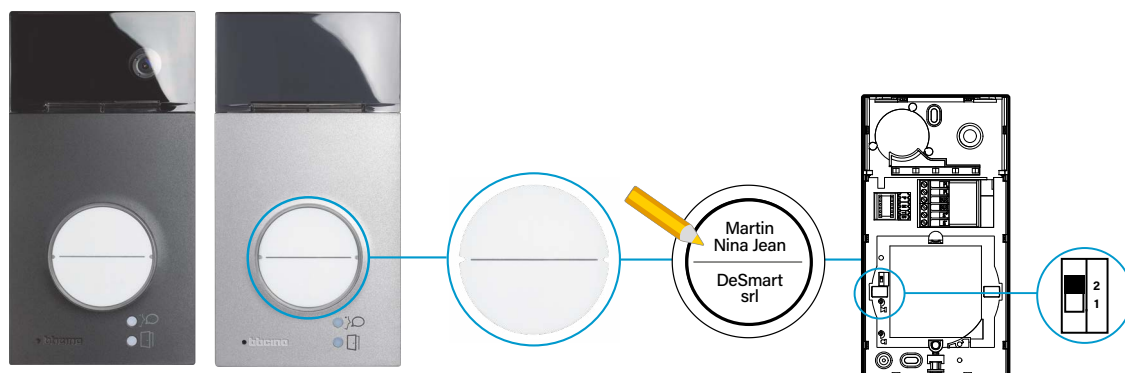



LINEA 3000 inside of the professional kits



For **ONE FAMILY** house installation, you have to buy only the kit and all you need is inside it.

For **TWO FAMILY** house installation, you have to buy the kit + an additional 2 wires internal unit. (refer to 2 wires system internal units range).

High installation flexibility

- **LINEA 3000** is sold for wall mounting installation but with the dedicated **accessories** (to be purchased separately), you can use the entrance panel for **flush mounting installation**.

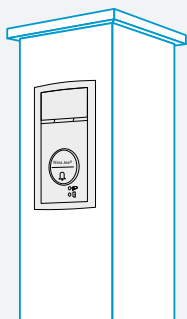

Also available in black version.

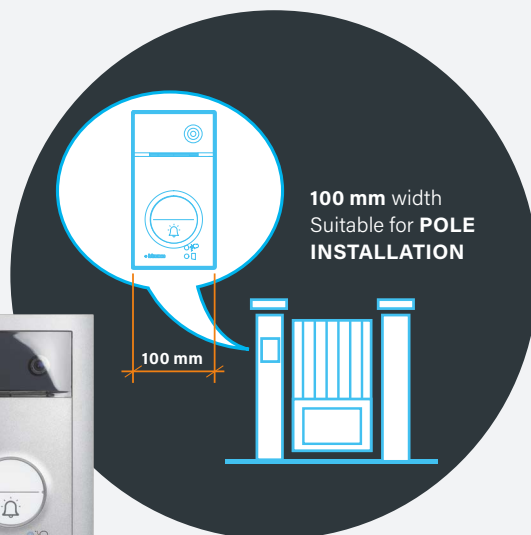

Ideal for renovations.....you can reuse the existing flush mounted box. Same 2 Modules Tersystem and SFERA flush mounting box.

- **LINEA 3000** can be wall mounted with the dedicated **rainshield accessory** (to be purchased separately).

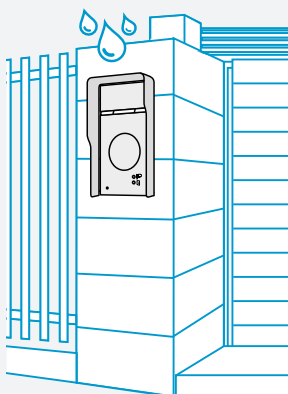

Also available in black version.

2 WIRES SYSTEM

Entrance panel

LINEA 3000



THE ENTRANCE PANELS RANGE
DEDICATED TO **VILLA STANDARD**

High level
applications

Modern aesthetics
feeling of quality



REFINED
detailing



BRANDED
quality



robustness
Zamak finishes



Weatherproof
(IP 54)
protection
degree



Robustness
(IK 10)
protection
degree



FLOATING
effect



HIDDEN
technology

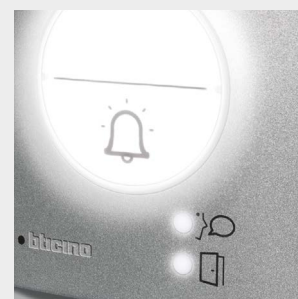

HIGH RELEVANCE
on interaction

Unique design and robust perception

Same look and ergonomics for all available versions:

LINEA 3000 video with door lock release badge



343093

343091



LINEA 3000 video



343081

LINEA 3000 audio



343071

Advanced functions

Wide angle camera

Horizontal and vertical wide viewing field. Easy to use for children and differently-abled People.



Door lock release

Door lock release with coloured badges or clear discs. Additional safe and comfort for all the residents.



2 WIRES SYSTEM

Entrance panel

LINEA 3000



343091



343093



343081



343071



348260

Item	LINEA 3000 Video entrance panel with door lock release proximity reader
343091	Wall mounted 2-Wires video pushbutton panel with Zamak front cover, wide angle colour camera and proximity reader. Fitted with white LED for the lighting of the shooting field in low light conditions. Can be set up for one or two family installation. It provides the possibility of opening an electrical door lock connected directly to clamps S+ and S- (18 V 4 A impulsive, 250 mA holding current, 30 ohm max). Can manage a maximum of 20 badges (125 KHz) for electrical door opening (master system badge included). White LED backlight name plate. Protection degree IP54 – protection against mechanical impact IK10. Supplied 1 set of door opening badges made up of : 6 coloured badges and 2 clear discs.
343093	Same as 343091 but in black finish

Item	LINEA 3000 Video entrance panel
343081	Wall mounted 2-Wires video pushbutton panel with Zamak front cover and wide angle colour camera.. Fitted with white LED for the lighting of the shooting field in low light conditions. Can be set up for one or two family installation. It provides the possibility of opening an electrical door lock connected directly to clamps S+ and S- (18 V 4 A impulsive, 250 mA holding current, 30 ohm max). White LED backlight name plate. Protection degree IP54 – protection against mechanical impact IK10.

Item	LINEA 3000 Audio entrance panel
343071	Wall mounted 2-Wires pushbutton panel with Zamak front cover. Can be set up for one or two family installation. It provides the possibility of opening an electrical door lock connected directly to clamps S+ and S- (18 V 4 A impulsive, 250 mA holding current, 30 ohm max). White LED backlight name plate. Protection degree IP54 – protection against mechanical impact IK10.

Item	LINEA 3000 Spare part front covers
343082	Spare part front cover for video entrance panels 343081 and 343091.
343072	Spare part front cover for audio entrance panel 343071.

Door lock release badge

348260	Set made up of 6 coloured badges which can be programmed to open the door
--------	---

Entrance panel
LINEA 3000



343051



343053



343061



343063



350020

Item	LINEA 3000 Rainshield accessory
343051	Rainshield roof accessory for Linea 3000 (343071 – 343081 – 343091) entrance panels. To be purchased separately.
343053	Rainshield roof accessory for Linea 3000 (343093) entrance panel. To be purchased separately.

Item	LINEA 3000 Flush mounting accessory + plastic box
343061	Flush mounting frame accessory for Linea 3000 (343071 – 343081 – 343091) entrance panels. To be purchased separately.
343063	Flush mounting frame accessory for Linea 3000 (343093) entrance panel. To be purchased separately.
350020	Plastic box suitable for the flush mounting installation of Linea 3000 entrance panels (343071 - 343081 - 343091 - 343093) together with the specific frame accessory 343061 - 343063. To be purchased separately.



2 WIRES SYSTEM

Entrance panel

LINEA 300



343031



343032



342911



342921



342931



342941

Item	Wall mounted colour video entrance panel
343031	2 WIRE video pushbutton panel with a call key and colour camera. Fitted with white LEDs for the lighting of the shooting field in low light conditions. Aluminium front cover. Nameplate lit by green LED
343032	As item 343031, but with 2 call pushbuttons

Item	Wall mounted audio entrance panel
342911	2 WIRE audio pushbutton panel with one call pushbutton for wall mounted installation. Aluminium front cover. Nameplate lit by green LED
342921	As item 342911, but with 2 call pushbuttons
342931	As item 342911, but with 3 call pushbuttons
342941	As item 342911, but with 4 call pushbuttons

Entrance panel

LINEA 2000L



343062



343064



332710

Articolo	Linea 2000L2 video entrance panel with 2 pushbuttons
343062	2-Wire video entrance panel for surface- or flush-mount installation, featuring a black aluminum front plate and a 2 MP colour camera with $\pm 15^\circ$ tilt adjustment on both vertical and horizontal axes. Equipped with an integrated brightness sensor for nighttime backlighting of name tags and white LEDs to illuminate the field of view in low-light conditions. Configurable for single- or two-family setups via the two front buttons. Supports activation of an electric lock connected directly to the S+ and S- terminals (18 V, 4 A impulse; 250 mA holding current; max 30 Ω). Relay terminals (C/NC/NO) are also provided for managing a second lock. Rated IP44 for protection. Compatible with the 332710 flush-mount box.

Articolo	Flush-mounted installation box
332710	Flush-mounted box for Linea 2000L2 and Linea 2000L4 push-button panels.

Articolo	Linea 2000L4 video entrance panel with 4 pushbuttons
343064	2-Wires video entrance panel for surface or flush-mount installation, featuring a black aluminum front and a 2 MP colour camera with $\pm 15^\circ$ tilt adjustment on both vertical and horizontal axes. An integrated brightness sensor provides nighttime backlighting for the name tags, while white LEDs illuminate the field of view in low-light conditions. Configurable for installations with up to four apartments using the four front buttons. Supports activation of an electric lock connected directly to the S+ and S- terminals (18 V, 4 A impulse; 250 mA holding current; max 30 Ω). Relay terminals (C/NC/NO) are also available for controlling a second lock. Rated IP44. Compatible with the 332710 flush-mount box.

Entrance panel

LINEA 100



343101



343102



343100

Item	Pushbuttons audio entrance panel
343101	2 WIRE audio pushbutton panel with 4 call pushbuttons for wall mounted installation. It's fitted with rainshield and internal contact (C - NO - NC) for the connection of an electrical door lock or external actuator (for the power supply to the electrical door lock allow for the installation of auxiliary transformer item 336482). Connections (PL) for a local door lock release pushbutton
343102	2 WIRE audio pushbutton panel with 8 call pushbuttons for wall mounted installation. It's fitted with rainshield and internal contact (C - NO - NC) for the connection of an electrical door lock or external actuator (for the power supply to the electrical door lock allow for the installation of auxiliary transformer item 336482). Connections (PL) for a local door lock release pushbutton

Item	Digital call audio entrance panel
343100	2 WIRE AUDIO digital call pushbutton panel for wall mounted installation. The device consists of a pushbutton panel with 16 keys and a digital display showing the operating status. Using previously saved numerical (SCS addresses) or alphanumeric (logical addresses) codes, it is possible to call the internal units, and for the residents to release the door lock using a dedicated numerical code. The pushbutton panel manages up to 4000 internal unit addresses (from 0 to 3999), as well as the direct call to the 2 WIRE switchboard. It's fitted with rainshield and internal contact (C - NO - NC) for the connection of an electrical door lock or external actuator (for the power supply to the electrical door lock allow for the installation of auxiliary transformer item 336482). Connections (PL) for a local door lock release pushbutton



2 WIRES SYSTEM

Entrance panel

LINEA 300



308001
308011



308002
308012



308003
308013

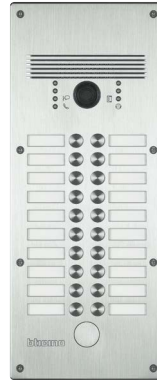

308004
308014



308022

Item	Aluminium finish pushbutton panel
308001	Monobloc vandal-resistant 2 WIRE video pushbutton panel for 2 and 4 calls with aluminium finish. The item code includes: flush mounted box, frame, colour video and audio electronic module, prewired pushbutton module/s. Presetting for the mounting of transponder reader or key switch. Backlit call keys. Visual and sound notifications of the communication status for: call active, system busy, door lock status
308002	As item 308001 but for up to 8 calls
308003	As item 308001 but for up to 12 calls
308004	As item 308001 but for up to 20 calls
308005	As item 308001 but for up to 32 calls

Item	Stainless steel finish pushbutton panel
308011	Monobloc vandal-resistant 2 WIRE video pushbutton panel for 2 and 4 calls with stainless steel finish. The item code includes: flush mounted box, frame, colour video and audio electronic module, prewired pushbutton module/s. Presetting for the mounting of transponder reader or key switch. Backlit call keys. Visual and sound notifications of the communication status for: call active, system busy, door lock status
308012	As item 308011 but for up to 8 calls
308013	As item 308011 but for up to 12 calls
308014	As item 308011 but for up to 20 calls
308015	As item 308011 but for up to 32 calls

Wall mounted boxes	
308021	Wall mounted box for pushbutton panels, items 308001-308011
308022	Wall mounted box for pushbutton panels, items 308002-308012
308023	Wall mounted box for pushbutton panels, items 308003-308013
308024	Wall mounted box for pushbutton panels, items 308004-308014
308025	Wall mounted box for pushbutton panels, items 308005-308015



308040

308026



Digital call entrance panel with flush mounting box

Item Digital call entrance panel

308040 Monobloc vandal-resistant 2 WIRE digital call video pushbutton panel (in stainless steel), flush mounted or wall mounted installation (with specific box item **308026** sold separately). The item includes: flush mounted vandal-resistant steel box, audio and video module with wide angle colour camera, integrated graphic display, and alphanumeric keypad for direct apartment call, fast address book search, and door lock release using a code. Presetting for the installation of a T25 Vigik reader, or a key switch. Backlit display and BLUE keys. It is possible to store up to 4000 residents names. Visual, sound, or control speech synthesis communication status notification, for example: call active, system busy, door lock status. Direct control of an electric door lock 18V-4A impulsive, 250 mA holding current (30 ohm max). System power supply cuts do NOT cause the loss of memory data. Selectable display menu languages are: Italian, English and French. The device can be configured physically or using a PC with the specific software, which can be downloaded free of charge from www.bticino.com

308026 Wall mounted box for digital call entrance panel **308040**

INTERNAL UNITS RANGE

CLASSE 300X

CLASSE 300EOS

CLASSE 100

SPRINT L2



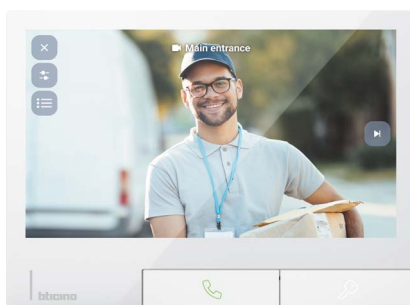

CLASSE 300X



CLASSE 300EOS

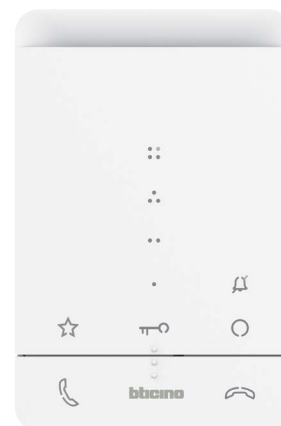
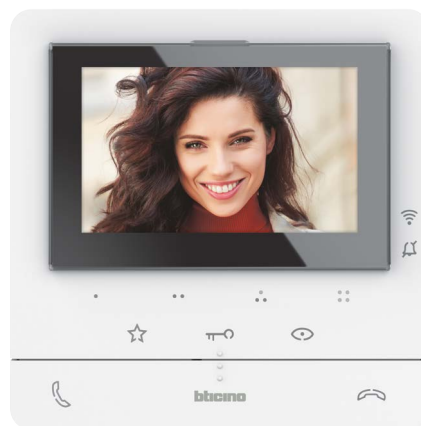



CLASSE 100X16E

CLASSE 100A16E

2 WIRES SYSTEM

Internal units

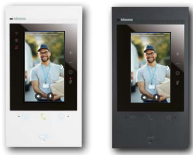



overview and features

	Classe 300X	Classe 300EOS	Classe 100X16E	Classe 100V16E
				
Audio				
Colour video	●	●	●	●
Handsfree	●	●	●	●
Call redirection on smartphone	●	●	●	
Integrated Alexa voice assistant		●		
Wifi connection	●	●	●	
Finishes / Colours	Dark - Light	White - Black	White	White
Display	LCD Touch 7"	LCD Touch 5"	LCD 5"	LCD 5"
Answering machine	●	●		
Floor call	●	●	●	●
Door lock release	●	●	●	●
Staircase light control	●	●	●	●
Scrolling EP activation	●	●	●	●
Intercom (1)	●	●	●	●
Inductive loop (2)		●	●	●
Professional studio function	●	●	●	●
Safe door lock function	●	●	●	●
Notifications / Message function	●	●		
Quick link / Favourite	●	●		
Wall-mounted installation	●	●	●	●
Tabletop installation	●		●	●

(1) The intercom function allows for up to 3-minute communication between and among video door entry systems in the same apartment / in different apartments.

(2) Use by people wearing hearing aids fitted with (T) selector.

(3) Activated with specific configuration inserted in P.

	Classe 100V16B	Classe 100V16M	Classe 100A16E	Classe 100A16M	Sprint L2
					
			•	•	•
	•	•			
	•		•		
	White	White	White	White	White
	LCD 5"	LCD 4,3"			
	•	•	•	•	•
	•	•	•	•	•
	•	•	•	•	• (3)
	•	•	•	•	• (3)
	•	•	•	•	
			•	•	
	•	•	•	•	
		•			
	•	•	•	•	•
	•		•	•	



CLASSE300X

Simple for everyone. Perfect for you.

Classe 300X

One smart concept,
just two keys.



The new Classe 300X video internal unit has been designed to offer unprecedented interaction simplicity, redefining the user experience in the residential video door entry system sector.

Classe 300X

Advanced technology
accessible to everyone

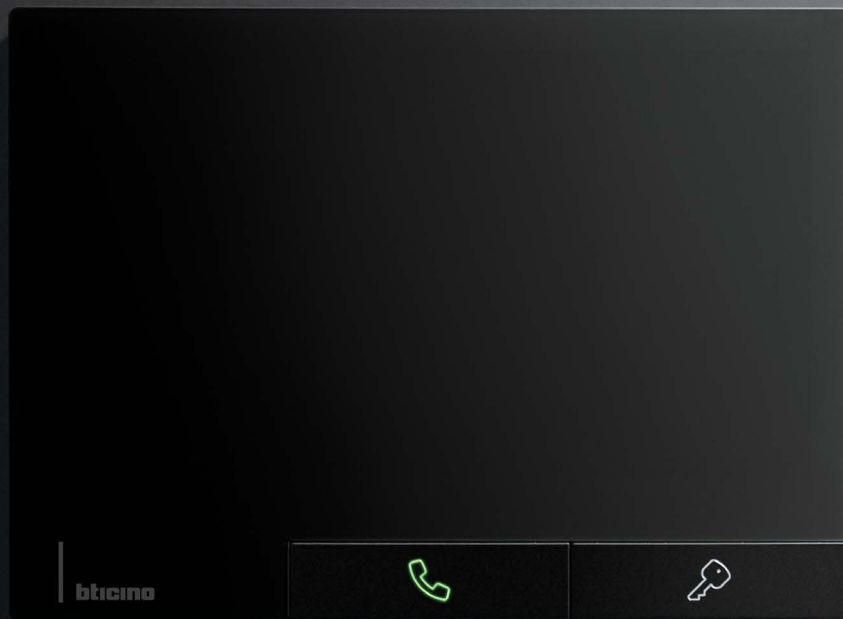

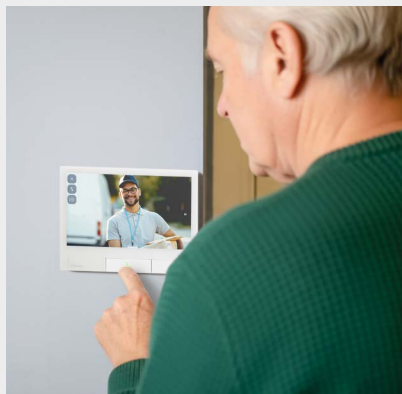

Classe 300X: designed to be simple and straightforward for anyone.

The Classe 300X video internal unit integrates a 7" touch screen display with 1024 x 600 resolution for sharp, high-quality images. Thanks to the integrated digital echo canceller, audio is crystal clear and free of interference. The dual-band Wi-Fi 6 (2.4 GHz and 5 GHz) connectivity ensures even faster and more stable remote control, fully integrated with the BTicino Home+Security App.



7" touch screen display
resolution 1024 x 600 pixel

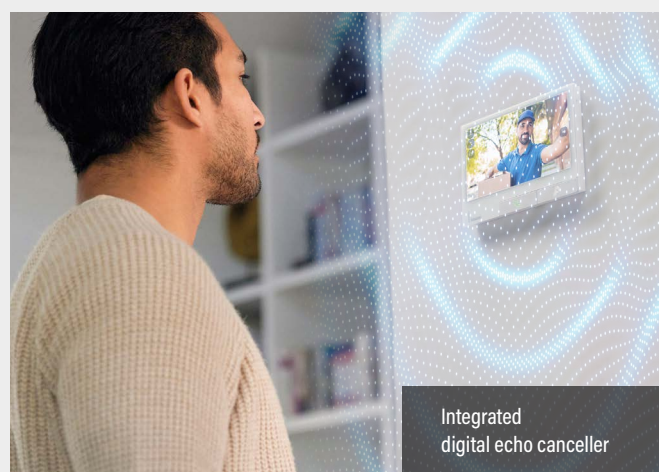

Integrated digital echo canceller

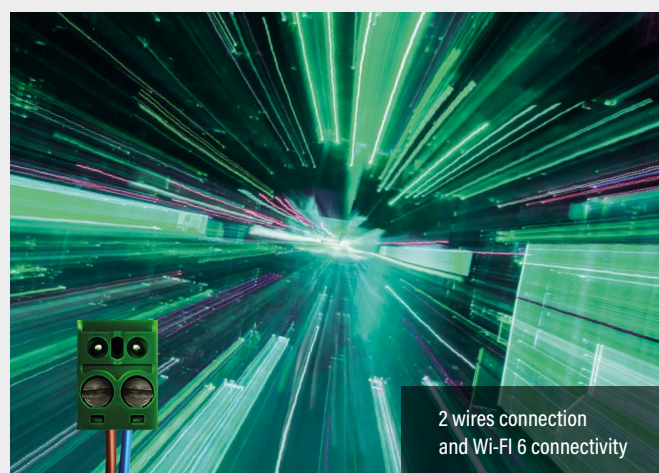

2 wires connection and Wi-Fi 6 connectivity

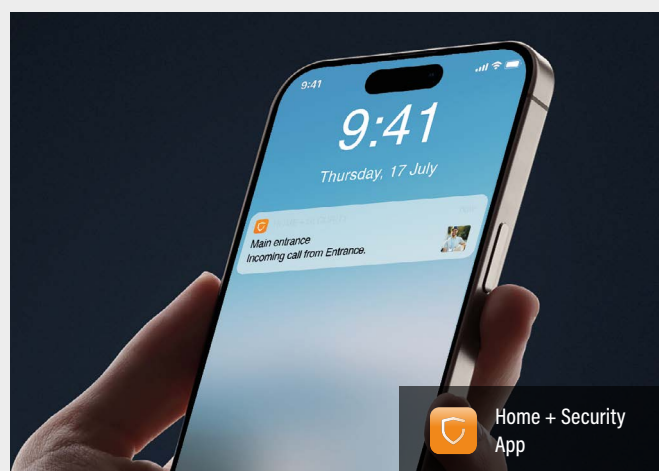

Home + Security App

Classe 300X

Dark
finish



Essential design, absolute elegance.

The Dark finish enhances the refined lines of the Classe 300X, with a full screen glass surface that provides an immersive and contemporary visual experience. A perfect balance of technology and style for every modern environment.



Classe 300X

Light
finish



Classe 300X in Light finish **exhibits an understated and homely elegance.** More traditional than the Dark version, the white look fits naturally in domestic environments, conveying a sense of continuity, tradition and reassuring familiarity.

Classe 300X

Every detail speaks sustainability

Every material, every component and every detail stem from a precise idea: reduce environmental impact and enhance value. It's not just efficiency; it's a new concept of responsibility where every improvement, even technical, is a step toward a sustainable future.

Materials that are reborn: glass and recycled plastic.

The shell is designed to last and to be environmentally friendly.

Dark version: made from more than **80% mechanically recycled plastic**, to give new life to existing materials.

Light version: **more than 25% chemically recycled plastic**, a choice that allows high technical performance but with less environmental impact.

Glass: a recyclable material, synonymous of transparency and quality.



Zero plastic, all substance: 100% plastic-free and FSC-certified packaging.

Packaging made from paper and cardboard.
100% plastic-free.

FSC mix certification, guaranteeing a responsible supply chain and sourcing from sustainably managed forests.



Efficiency that puts less strain on the environment: reduced consumption and lighter components.

A more efficient design even in invisible moments:
-31% stand-by consumption compared to the previous model. Silent saving that reduces waste and environmental costs.

CO₂ under control.

A life cycle designed to put less strain on the environment:
-33% CO₂ emissions compared to the previous model. Result achieved through lower consumption, lighter electronic components and display, and the use of recycled materials.

>80%
of recycled plastic
in the Dark version

100%
plastic-free
packaging

-31%
consumption
in stand-by*

-33%
of CO₂*
emissions

(*) compared to the previous Classe 300X model.

Classe 300X

Connections and functions

Front view

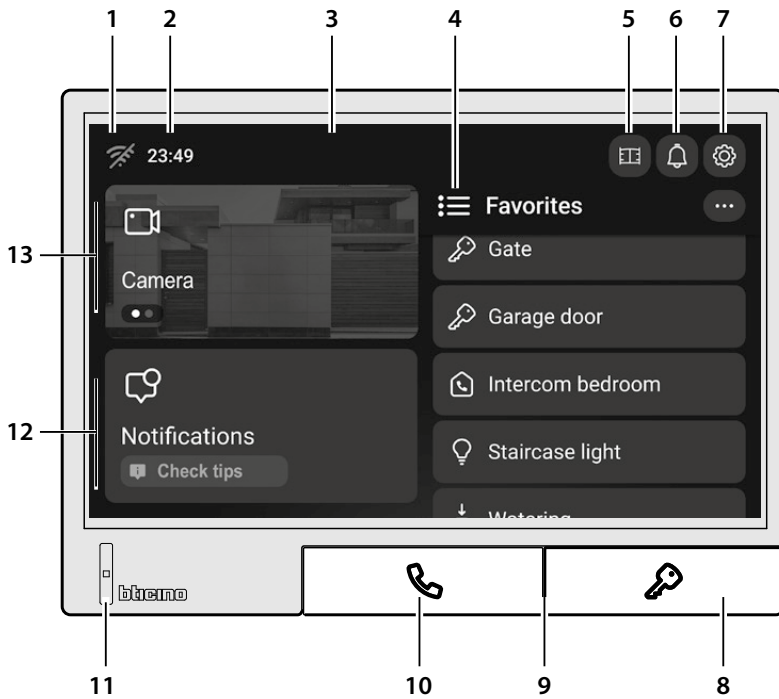

- 1 - Wi-Fi signal indication
- 2 - Time indication
- 3 - 7-inch touch screen display
- 4 - Favourites menu
- 5 - Professional studio (office) (ON = Enabled)
- 6 - Ringtone (🔔 = Enabled) (🔕 = Disabled)
- 7 - Settings menu
- 8 - Physical key for door lock activation
- 9 - Microphone
- 10 - Physical key for audio communication activation/deactivation
- 11 - Multicolour LED that indicates the operating status
- 12 - Notification area
- 13 - Camera area

Rear view

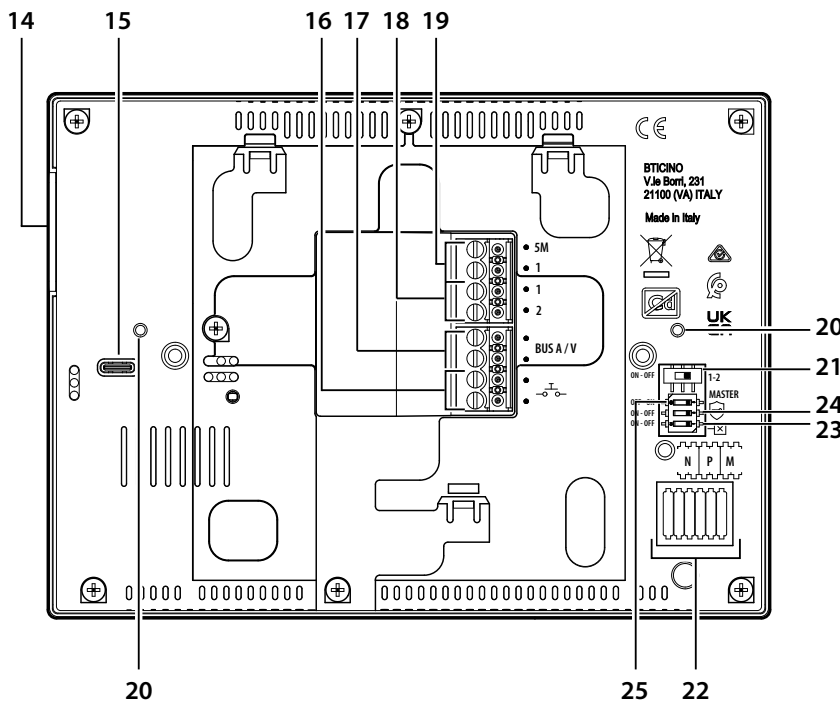

- 14 - Speaker
- 15 - USB-C for firmware update
- 16 - Clamps () for the connection of a call to the floor pushbutton
- 17 - 2 Wires SCS/BUS clamps
- 18 - Additional power supply clamps (1 - 2)
- 19 - Additional ringtone connection clamps (5M - 1)
- 20 - Table-top base fastening position (334632)
- 21 - ON/OFF micro-switch to enable the additional power supply
- 22 - Configurator socket (N - P - M)
- 23 - Line termination ON/OFF micro-switch
- 24 - ON/OFF micro-switch for "safe door lock" function
- 25 - Master/Slave micro-switch

Classe 300X

Main features and functions

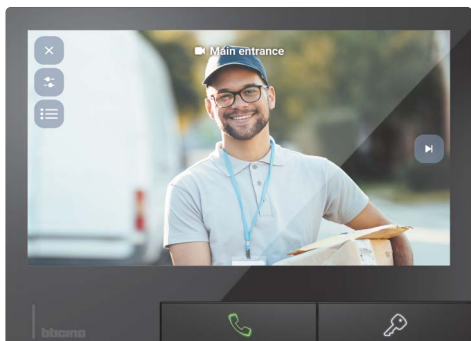

344743

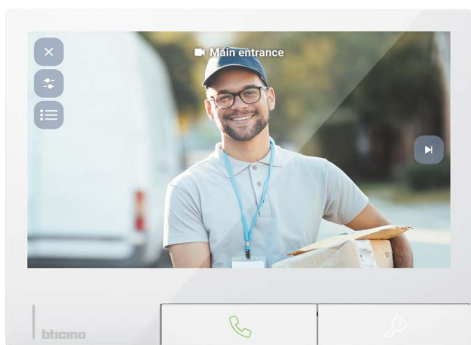

344742



MAIN FEATURES

- 7" touch screen colour LCD display
- Hands-free communication
- Dark and Light finishes
- Wall mounted installation using the supplied bracket
- Table-mounted installation with accessory base (344632)
- Available in Kit - (363942 - 363943)

AVAILABLE FUNCTIONS FROM VIDEO INTERNAL UNIT

- Activation of the electrical door lock
- Staircase light activation
- Entrance panel/scrolling activation
- Intercom
- Floor call
- Professional studio (customisable)
- Video door entry answering machine
- Master / Slave
- Safe door lock
- Wi-Fi connectivity
- Notification management
- Quick link - favourite / most used functions
- Favourite control
- 15 available ringtones

AVAILABLE FUNCTIONS FROM HOME + SECURITY APP

- Answer a video door entry system call
- Activation of the electrical door lock
- Entrance panel/scrolling activation
- Staircase light activation
- Activation and monitoring of the smart Netatmo cameras
- Management of the Netatmo Security devices (smoke sensor, burglar-alarm siren, opening sensor...)
- Video door entry answering machine
- Intercom call from smartphone to video internal unit
- History of the events

2 WIRES SYSTEM

Catalogue

Classe 300X

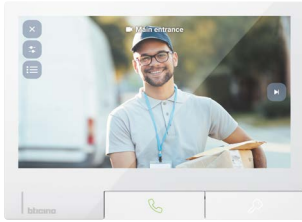

344742



344743



344632



346020

Item **Classe 300X video internal unit - Light finish**

344742

2 wires/Wi-Fi hands-free connected video internal unit, Light finish, with 7" horizontal touch screen LCD display, resolution 1024 x 600 pixel. Featuring two physical keys for answering/ending calls, entrance panel activation, and controlling the electric door lock.

The remaining video door entry system functions e.g. entrance panel activation, camera scrolling, additional door lock activation, video door entry system answering machine, staircase light control, intercom etc. are managed via specific menus and touch display.

Featuring a digital echo canceller for better audio quality. LED visual signals for: Wi-Fi network connection status, info / notifications and call exclusion. Using the touch display, it is possible to access the notification list, as well as your favourite door entry controls. Advanced 'Professional Studio' and 'Do Not Disturb' functions: customisable and schedulable by day/time. Possibility of voice communication with the switchboard - if present in the system - after a specific call. The device must be configured by physically connecting the configurators, or using the menu and the touch display, which will give better possibilities of customisation of associated functions and texts.

Thanks to the Wi-Fi 6 connectivity, the video door entry system can connect to 5 GHz or 2.4 GHz band routers to take advantage of the functions available on the Home + Security App (available for Android and iOS): call reception, door lock release, event timeline display, entrance panel activation, camera scrolling and advanced «Professional Studio» and «Do Not Disturb» functions.

Using the Home + Security App, it is also possible to manage products from Netatmo security offering. 15 different ringtones available.

Wall mounted installation using the bracket supplied and tabletop installation (with support 344632) to be purchased separately.

Made with over 25% chemically recycled plastic. Designed, engineered, and manufactured in Italy.

Item **Classe 300X video internal unit - Dark finish**

344743

As the video internal unit 344742 but with Dark finish. Made with over 80% mechanically recycled plastic.

Tabletop support for Video internal unit

344632

Accessory support for the tabletop installation of the Classe 300X video internal units (344742 – 344743).

2 DIN additional power supply

346020

Additional 2 DIN power supply to be used to supply Classe 300X video internal units locally using the clamps (1 – 2).



Catalogue

Linea 3000 - Classe 300X kit



H + S

363942



H + S

363943

Item	Kit with Linea 3000 Black finish with RFID key card and Classe 300X Light finish
363942	<p>One-family hands-free kit with Classe 300X hands-free connected video internal unit (Light finish) and Linea 3000 pushbutton panel (black finish).</p> <p>2 wires/Wi-Fi hands-free connected video internal unit, Light finish, with 7" horizontal touch screen LCD display, resolution 1024 x 600 pixel. Featuring a digital echo canceller for better audio quality. Thanks to the Wi-Fi 6 connectivity, the video door entry system can connect to 5 GHz or 2.4 GHz band routers to take advantage of the functions available on the Home + Security App (available for Android and iOS): call reception, door lock release, event timeline display, entrance panel activation, camera scrolling and advanced «Professional Studio» and «Do Not Disturb» functions. Through the Home + Security App, it is also possible to manage the products of the Netatmo security range. This allows you to quickly and easily create a Smart security system. Linea 3000 pushbutton panel with black finish zamak front cover and proximity reader with a kit of coloured RFID key cards and two clear discs for door lock release. Can be wall or flush installed with specific accessories: (350020) flush mounted box and (343063) flush mounted accessory - to be purchased separately. Can be fitted with rainshield (343053) - to be purchased separately. The pushbutton panel has a protection index IP54 - protection index against mechanical impact IK10.</p>

Item	Kit with Linea 3000 Black finish with RFID key card and Classe 300X Dark finish
363943	<p>One-family hands-free kit with Classe 300X hands-free connected video internal unit (Dark finish) and Linea 3000 pushbutton panel (black finish).</p> <p>2 wires/Wi-Fi hands-free connected video internal unit, Dark finish, with 7" horizontal touch screen LCD display, resolution 1024 x 600 pixel. Featuring a digital echo canceller for better audio quality. Thanks to the Wi-Fi 6 connectivity, the video door entry system can connect to 5 GHz or 2.4 GHz band routers to take advantage of the functions available on the Home + Security App (available for Android and iOS): call reception, door lock release, event timeline display, entrance panel activation, camera scrolling and advanced «Professional Studio» and «Do Not Disturb» functions. Through the Home + Security App, it is also possible to manage the products of the Netatmo security range. This allows you to quickly and easily create a Smart security system. Linea 3000 pushbutton panel with black finish zamak front cover and proximity reader with a kit of coloured RFID key cards and two clear discs for door lock release. Can be wall or flush installed with specific accessories: (350020) flush mounted box and (343063) flush mounted accessory - to be purchased separately. Can be fitted with rainshield (343053) - to be purchased separately. The pushbutton panel has a protection index IP54- protection index against mechanical impact IK10.</p>

Item	Kit composition	Q.ty
343093	Linea 3000 pushbutton panel with Black Zamak finish	1
344742	Classe 300X video internal unit with Light finish	1
346050	6 DIN power supply	1
346250	Door lock relay accessory	1
348260	Set of coloured door lock release key cards	1
	Set of door lock release clear discs	1

Item	Kit composition	Q.ty
343093	Linea 3000 pushbutton panel with Black Zamak finish	1
344743	Classe 300X video internal unit with Dark finish	1
346050	6 DIN power supply	1
346250	Door lock relay accessory	1
348260	Set of coloured door lock release key cards	1
	Set of door lock release clear discs	1

Internal units

Classe 300EOS



The smart vision of the home.

Distinctive design to meet the needs of contemporary living. Vertical and super slim. With its clean and modern design, it gives every type of home an innovative look, and offers a unique user experience.



Vertical display and curved shape:
a disruptive and modern design,
but also understated.



5" Touch Screen

Vertical display
for a better view
of the caller

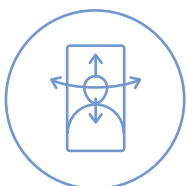
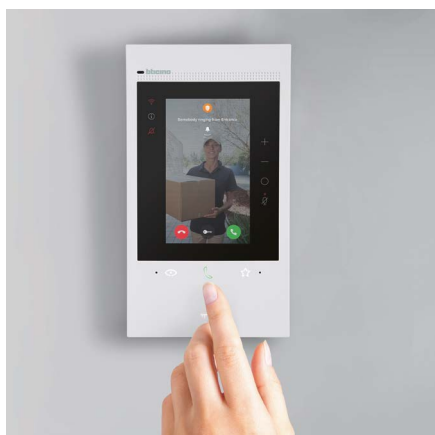

Face detection

Automatic centring of the
subject on the display

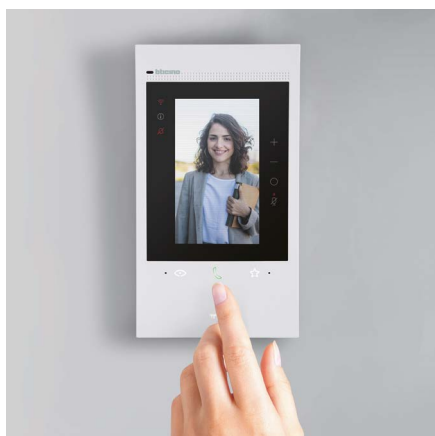

Horizontal display

Double "tap" the display
to view the image
in landscape format



Curved shape

The shape of a welcome:
a "welcoming effect"
for residents and guests.



2 WIRES SYSTEM

Internal units

CLASSE 300EOS with Netatmo

Front view

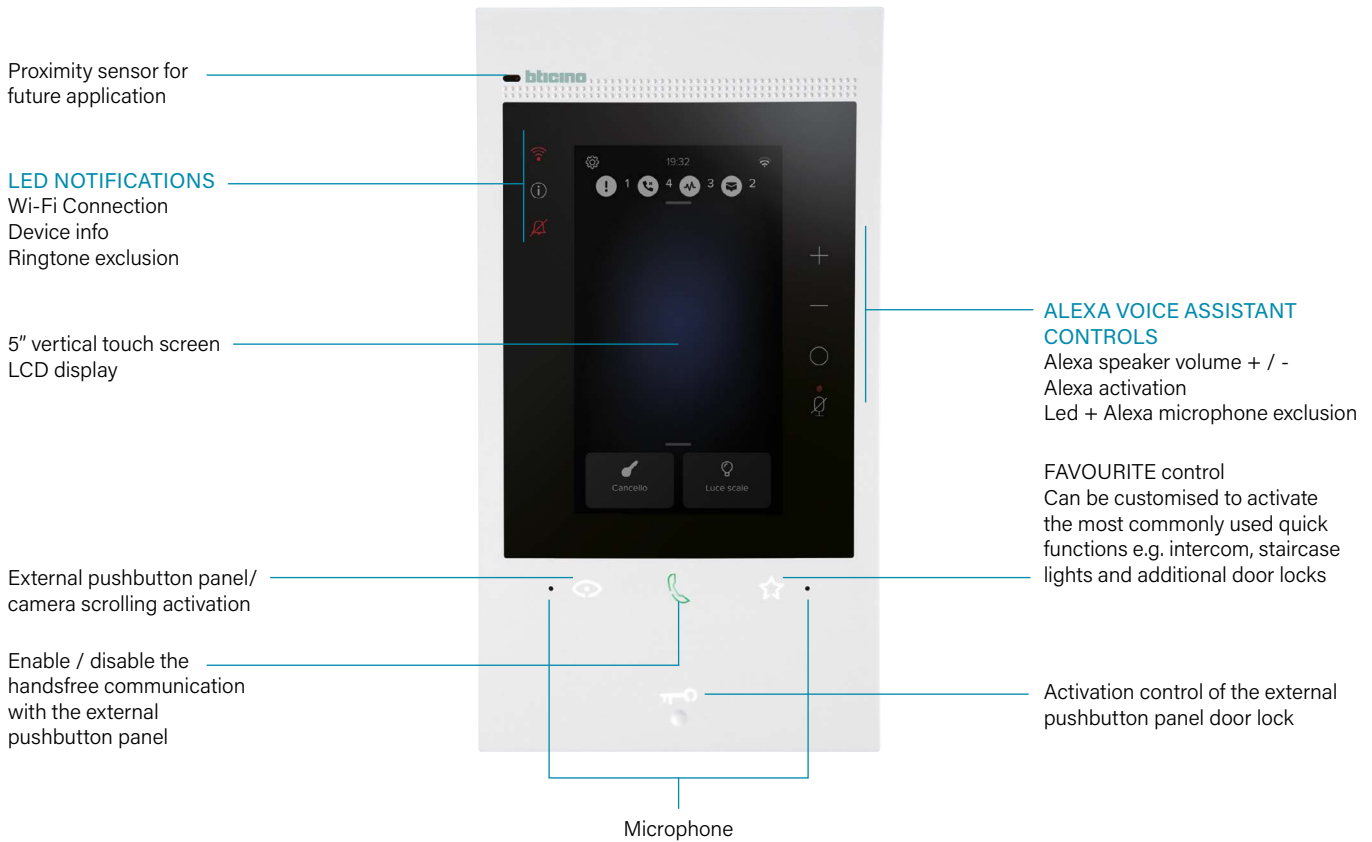

Back view

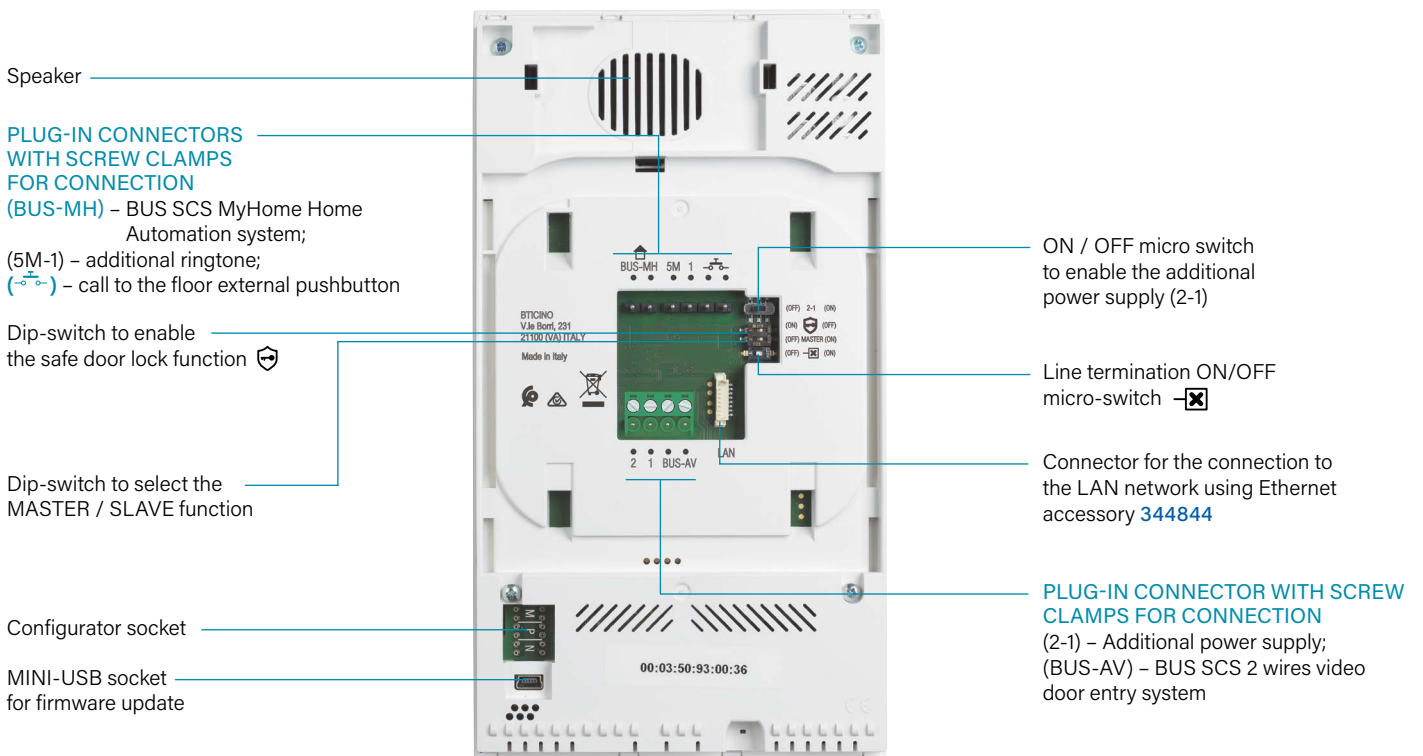

Internal units

CLASSE 300EOS with Netatmo



344842



344884



344844



346020

Item **CLASSE 300EOS with Netatmo connected video internal unit - white finish**

344842

2 wires/Wi-Fi handsfree connected video internal unit white finish with built-in Amazon Alexa voice assistant, 5" vertical touch screen LCD display and video door entry answering machine. Integrated SCS Server for managing MyHOME wired systems. It can be used alternatively to the SCS Server DIN Item MhServer 1. It has a physical key for door lock release and capacitive keys for the control of the main video door entry functions: handsfree communication, entrance panel activation / camera scrolling and Favourite key (can be configured to activate the quick actions most frequently used – e.g. additional door locks, staircase light control, intercom).
 There are notification LEDs for:
 Wi-Fi network connection status, info / notifications and call exclusion. It is possible to easily interact with the built-in Alexa voice assistant, either using the dedicated capacitive keys or with your voice, and activate several functions, such as the video door entry functions, Smart Home, scenarios, reminders etc. Using the touch display, it is possible to access the notification list, as well as your favourite door entry, security and Smart Home controls (if any). The device must be configured by physically connecting the configurators or using the menu, which will give better possibilities of customisation of associated functions and texts. Thanks to the Wi-Fi connection, you can associate the video internal unit to the Home + Security App (available for Android and iOS). The App allows to use the main video internal unit functions (receiving calls, door lock release, display of the event timeline and activation of the entrance panel/camera cycling). Through the Home + Security App, it is also possible to manage the products of the Netatmo security range. This allows you to quickly and easily create a Smart security system. Wall mounted installation using the supplied bracket. Possibility of Wi-Fi connection or using RJ45 ethernet cable with the dedicated accessory 344844.

Item **CLASSE 300EOS with Netatmo connected video internal unit - black finish**

344884

Same as 344842 but in Black finish.

Ethernet accessory

344844

Accessory cable for the wired connection of the Classe 300EOS video internal unit using an RJ45 Ethernet cable. To be purchased separately.

2 DIN additional power supply

346020

Additional 2 DIN power supply to be used to supply the connected CLASSE 300EOS video internal units (344842 - 344884) locally, when required.



Internal units

Classe 100

Classe 100 X16E

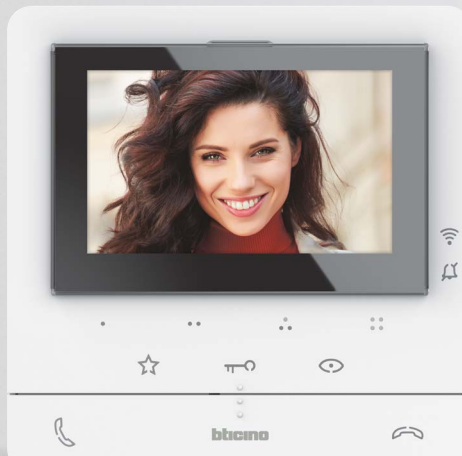

Now the standard is connected

BTicino introduces Wi-Fi connectivity to the standard video door entry segment.

BTicino renews the range of **Classe 100** indoor units by introducing Wi-Fi connectivity in the standard video door entry system offer. The result is a range of video and audio indoor units with a modern and elegant design, capable of meeting all installation needs.



Built-in connectivity for constant connection with the home.



Up to 22 apartments without dedicated power supply.



Immediate association with the Home + Security App.



Ideal for the refurbishment of old door entry systems.



No extra work for the installer; easier to use for the end user.



After being connected to **Classe 100X**, the smartphone becomes an "additional virtual video indoor unit" that can be used to answer calls, activate the opening of the door locks and activate the system cameras.

2 WIRES SYSTEM

Internal units

CLASSE 100

Features and functions

CLASSE 100 X16E	CLASSE 100 V16E	CLASSE 100 V16B	CLASSE 100 V16M	CLASSE 100 A16E	CLASSE 100 A16M
					
344682	344672	344652	344625	344282	344292

Features

LCD colour display	5 inches	5 inches	5 inches	4.3 inches		
Handsfree	●	●	●		●	
Finish	white	white	white	white	white	white
Available in KIT	364614	364612	364613		364232	364231
Installation	wall / table	wall / table	wall / table	wall	wall / table	wall / table

Available functions from audio / video indoor unit

Door lock activation	●	●	●	●	●	●
Staircase light activation	●	●	●	●	●	●
EP / Scrolling activation	●	●	●	●	●	●
Intercom (1)	●	●	●	●	●	●
Inductive loop (2)	●	●				
Floor call	●	●	●	●	●	●
No. of configurable keys	4	4	1	1	4	4
No. of available ringtones	20	16	16	16	16	16
Professional Studio (Office)	●	●			●	●
Wi-Fi connectivity	●					

Available functions from HOME + SECURITY APP





Answer video door entry system calls	●				
Door lock activation	●				
Staircase light activation	●				
Intercom call from smartphone to video indoor unit	●				
Management Netatmo Security devices (smoke sensor , burglar alarm siren , opening sensor	●				
EP / Scrolling activation	●				

1) Audio call, max. 3 minutes, between indoor units of the same apartment/different apartments

2) Use by people wearing hearing aids fitted with T selector

Front view

Touch sensitive controls

-  Door lock activation
-  Entrance panel/camera scrolling activation
-  Staircase light activation
-  Customisable controls for the activation of accessory functions (e.g. intercom, activation of additional door lock, various activations)

Physical control

Enable the handsfree communication

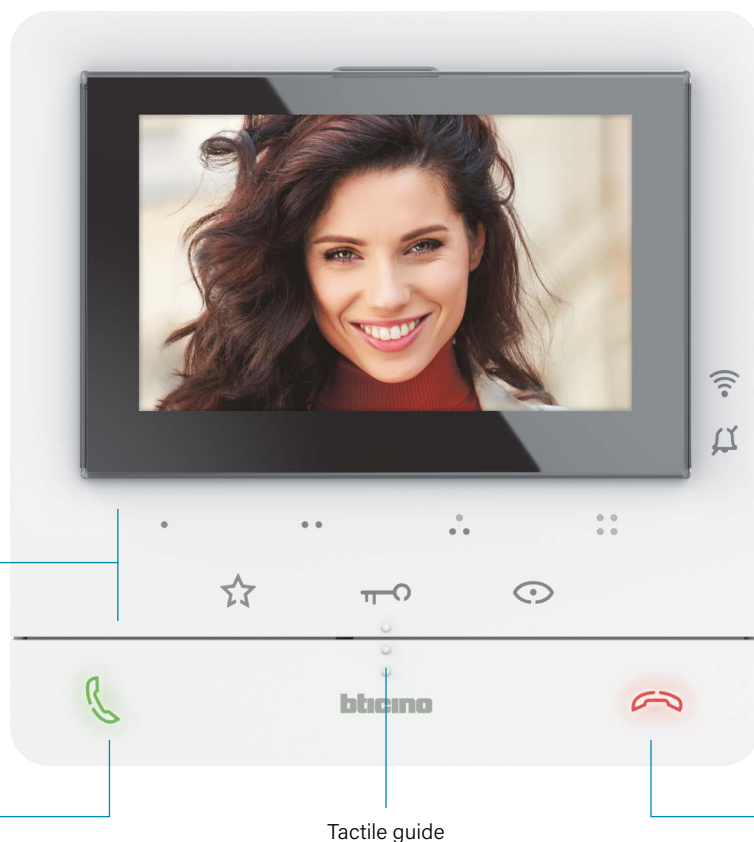

LED notifications

-  Wi-Fi Connection
-  Ringtone exclusion

Physical control

Disable the handsfree communication

Tactile guide

Back view

Plug-in connectors with screw clamps for connections

Adjustment and programming menu access and navigation joystick

Line termination ON/OFF micro-switch

ON / OFF micro switch to enable the additional power supply

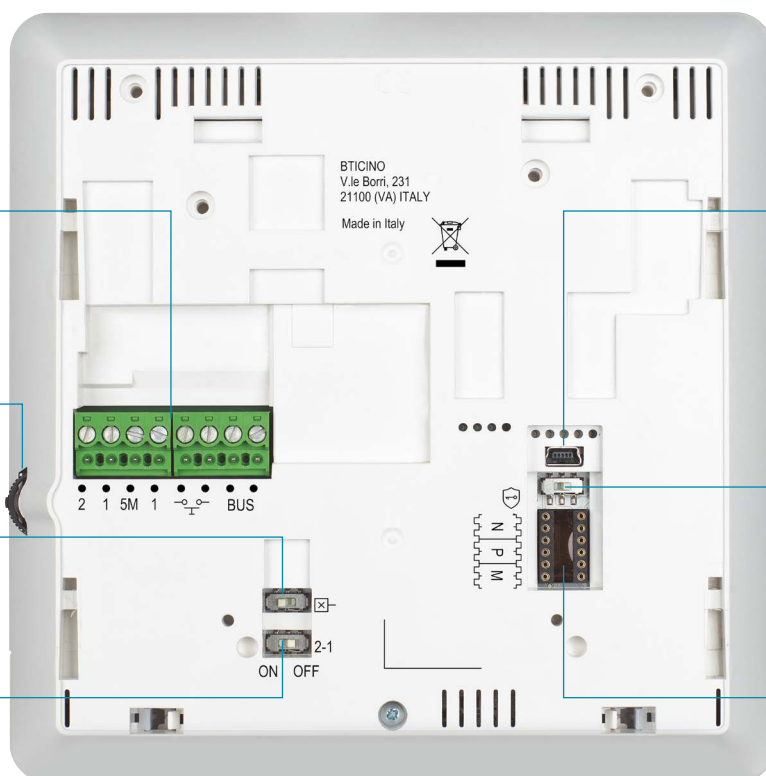

USB mini socket for firmware update

ON / OFF micro switch to enable the Safe Door Lock function

Configurator socket

2 WIRES SYSTEM

Internal units

CLASSE 100



344682

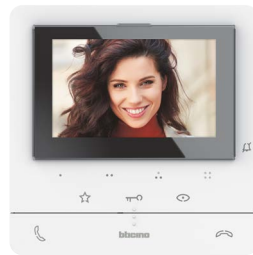

344672

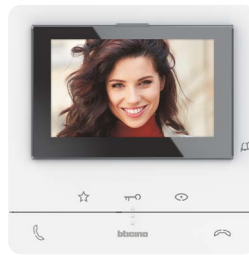

344652



344625



App Home + Security

Item	Classe 100X16E connected video indoor unit	Item	Classe 100V16B video indoor unit
344682	<p>Classe 100X16E with Netatmo 2 wires / Wifi handsfree connected video internal unit with inductive loop and 5" colour LCD display. It has 2 physical keys for the control of the main video door entry functions – answer and end a call – it has 3 touch keys for the control of the main functions – door lock release, staircase light control and entrance panel activation/scrolling – there are further 4 configurable touch keys that perform different functions – e.g. staircase light control, intercom, additional door lock activation, generic activations.</p> <p>The device has a side lever to adjust: colour, brightness and display contrast, audio volume, call tone volume and Wifi configuration. There are call exclusion notification LEDs and Wifi. Also, thanks to the Wifi connection, you can associate the video internal unit to the Home + Security App (available for Android and iOS). You can manage the main video internal unit functions (receiving calls, opening the door lock, activating the entrance panel/scrolling, FWR updating and additional activations) from the App. Through the Home + Security App it is also possible to manage the products of the Netatmo security offer. This allows you to quickly and easily create a Smart security system. The installation can be made to the wall using the bracket supplied or using table support accessories (2 x 344692) – to be purchased separately. The device, also equipped with the professional studio (office) function, must be configured.</p>	344652	<p>2 WIRES handsfree video indoor unit with 5" colour LCD display. The device has 2 physical keys for the control of the main video door entry functions – answer and end a call – and 3 touch keys that allow the door lock release, the entrance panel activation/scrolling and the customisation of a most frequently used quick action – e.g. staircase light control, intercom, additional door lock activation, generic activations.</p> <p>The device has a side lever to adjust: colour, brightness and display contrast, audio and call tone volume. There is a call exclusion notification LED.</p> <p>The installation can be made to the wall using the bracket (supplied) or using table support accessories (2 x 344692) – to be purchased separately. The device must be configured.</p>
344672	<p>Classe 100V16E video indoor unit</p> <p>2 WIRES handsfree video indoor unit , with inductive loop and 5" colour LCD display It has 2 physical keys for the control of the main video door entry functions – answer and end a call – it has 3 touch keys for the control of the main functions – door lock release, staircase light control and entrance panel activation/scrolling – there are further 4 configurable touch keys that perform different functions – e.g. intercom, additional door lock activation, generic activations.</p> <p>The video indoor unit has a side lever to adjust: colour, brightness and display contrast, audio and call tone volume. There is a call exclusion notification LED. The installation can be made to the wall using the bracket (supplied) or using table support accessories (2 x 344692) – to be purchased separately. The device also has Professional Studio (Office) function and must be configured.</p>	344625	<p>Classe 100V16M video indoor unit</p> <p>2 WIRES video indoor unit with handset and 4.3" colour LCD display, suitable for wall mounting installation (bracket support included). The device has three touch keys that allows : door lock release, entrance panel camera activation/scrolling and customization of an auxiliary function – e.g. additional door lock activation, additional camera activation.</p> <p>Side easily accessible and independent regulations for : call volume / ringtone exclusion (with notification LED), display colour and brightness. The handset has magnets for easy holding.</p>

Internal units

CLASSE 100

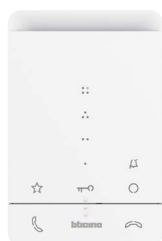

344282



344292



344692



336803



336982



346020

Item	Classe 100A16E handsfree audio indoor unit
344282	<p>2 WIRES handsfree audio indoor unit for wall mounted or table installation.</p> <p>It has 2 physical keys for the control of the main functions – answer and end a call – and has 3 touch keys for the control of the main functions – door lock release, staircase light control and entrance panel activation/scrolling – there are further 4 configurable touch keys that perform different functions – e.g. intercom, additional door lock activation, generic activations. The device has a side lever to adjust the audio volume and call tone and a call exclusion notification LED.</p> <p>The installation can be made to the wall using the bracket (supplied) or using table support accessory (1 x 344692) – to be purchased separately. The device also has Professional Studio (Office) function and must be configured.</p>
344292	<p>Classe 100A16M audio indoor unit with handset</p> <p>2 WIRES audio indoor unit with handset for wall mounted or table installation. It has 3 touch keys for the control of the main functions – door lock release, staircase light control and entrance panel activation/scrolling – there are further 4 configurable touch keys that perform different functions – e.g. intercom, additional door lock activation, generic activations. Ringtone volume adjustment (with call exclusion) using the appropriate selector. The installation can be made to the wall using the bracket (supplied) or using table support accessory (1 x 344692) – to be purchased separately. The device also has Professional Studio (Office) function and must be configured.</p>

Item	Accessories - table support - cable - sockets
344692	Table support accessory for CLASSE 100 audio and video hands-free indoor units.
336803	8-way cable with connector for tabletop support connection.
336982	<p>White Livinglight series 8-pole plug for the connection of the 336803 cable in tabletop installations.</p> <p>The socket is available also in the following finishings:</p> <ul style="list-style-type: none"> - LIVINGLIGHT (336983 - 336984); - AXOLUTE (349414 - 349415 - 349418); - MATIX (336985).
346020	<p>2 DIN additional power supply</p> <p>Additional 2 DIN power supply to be used for the local power supply to connected CLASSE 100x16E (344682) video indoor units in multi-family systems in complexes with more than 22 apartments.</p>

392050
392060392051
392061

391950

391951

391952

391954

391956

Item	Smart Original outdoor cameras
------	--------------------------------

392050

Original outdoor camera

The Intelligent Outdoor Security Camera offers advanced detection of people, animals and vehicles. It features a robust monobloc aluminium structure with a white finish and is made of ultra-resistant UV-protected glass and plastic materials. The 5 MP video sensor and 2K resolution enable H.264 encoding, ensuring efficient streaming and storage. The camera provides long-distance detection up to 20 metres, with a wide viewing angle of 130° and 16x digital zoom for detailed video analysis. An integrated microphone allows real-time audio monitoring, while the 12 W LED spotlight offers adjustable brightness for optimal visibility. Infrared night vision ensures clear images even in low light up to 15 meters. Access to the camera is protected by end-to-end encryption thanks to the Home + Security App. Designed specifically for outdoor use, the device is weatherproof and benefits from HZO protection for increased durability. Connectivity is provided by dual-band Wi-Fi, compatible with both 2.4 GHz and 5 GHz frequencies.

392051 As 392050 but with black finish.

392060 **Original outdoor camera with PoE**

The intelligent outdoor security camera combines high-performance technology and refined design, providing reliable surveillance in any environment. The monobloc aluminium body with white finish ensures exceptional durability, while the ultra-resistant glass and plastic components offer robust UV protection. Equipped with a 5 MP video sensor and 2K resolution ($\approx 2560 \times 1440$), the camera delivers sharp, detailed images. Long-distance detection – up to 20 m – enables precise identification of people, animals, and vehicles, supported by a 130° field of view and 16x digital zoom. The integrated microphone allows real-time audio monitoring, while the integrated LED spotlight (12 W) with adjustable intensity improves visibility. Infrared night vision extends up to 15 m, ensuring reliable performance even in total darkness. Access is encrypted and safely managed through the Home + Security App. Designed for outdoor use, the camera features HZO waterproof protection and connects via Power over Ethernet (PoE).

392061 As 392060 but with black finish.

Item	Smart Advance indoor cameras
------	------------------------------

391950

Advance indoor camera

Advance indoor camera with facial recognition optimised by artificial intelligence (AI). Smart shutter for privacy and filming only of strangers. Wi-Fi connection. Access to images live via smartphone and the Home + Security App. It can be combined with the indoor siren item NIS01-PRO to create a customised alarm system. Compatible with Alexa, Apple Homekit and Google Assistant. Adjustable monobloc body in painted aluminium. White colour.

391951 As 391950 but with black finish.

391952 **Advance indoor camera**

Indoor camera 391950 + accessory for installation with 3-module box with depth of at least 40 mm or BTicino 503E and PB503N boxes - white colour.

391953 As 391952 but with black finish.

391954 **PoE adapters**

PoE adapter to exclusively power and connect 391950/51 indoor cameras using a single cable to ensure a reliable and stable wired connection. White colour.

391955 As 391954 but with black finish.

391956 **Mounting accessories in 2-module boxes**

Accessory for installing the Advance indoor camera on a 2-module box with at least 40 mm depth. Also compatible with the BTicino 502E and PB502N boxes - white colour.

391957 As 391956 but with black finish.

CAUTION: The items are expected to be available during 2026. Please check with your technical sales representative.

Home + Security
App



NIS-01-PRO



NSA-PRO-EU



NCO-PRO

Smart indoor siren

NIS-01-PRO

Smart indoor siren with 110 dB alarm, pre-recorded sounds and vibration sensor for tamper detection. Battery power supply or with a cable (not supplied) using the USB micro port. It only works with the smart indoor camera and must be installed in the same room: Bluetooth Low Energy (BLE) wireless connection with the smart indoor camera. Declaration of conformity and FCC declarations. Open-source compatibility. Operation using the Home + Security app.

Smart smoke detector

NSA-PRO-EU

Smart smoke detector with 85 dB alarm, high performance photoelectric sensor, average coverage 50 m², notifications on the smartphone through the Home + Security App

Smart carbon monoxide detector

Item

NCO-PRO

Intelligent wall-mounted carbon monoxide detector. Monitors combustion appliances (boiler, fireplace, wood stove, gas cooker, etc.) by measuring carbon monoxide levels in real time. When carbon monoxide is detected, it triggers its 85-decibel alarm and sends a real-time notification to the smartphone. Featuring a 10-year battery: the maximum lifespan for all carbon monoxide detectors. The Auto-Test function checks for correct operation. If a problem is detected, it sends a notification to the smartphone. Reliability guaranteed by CE (EN 50291) and NF certifications. Standalone device, no hub required. Compatible with Apple HomeKit. Operation using the Home + Security app. Requirements: it needs high-speed wireless internet connection. Public hotspots are not supported. The intelligent carbon monoxide alarm will detect carbon monoxide and emit a sound alarm even if the Wi-Fi is not configured. However, Wi-Fi is required to receive smartphone alerts. Wi-Fi 802.11 b/g/n (2.4 GHz), Open/WEP/ WPA/ WPA2-Personal, Bluetooth Low Energy (BLE)

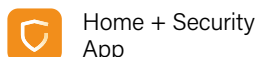
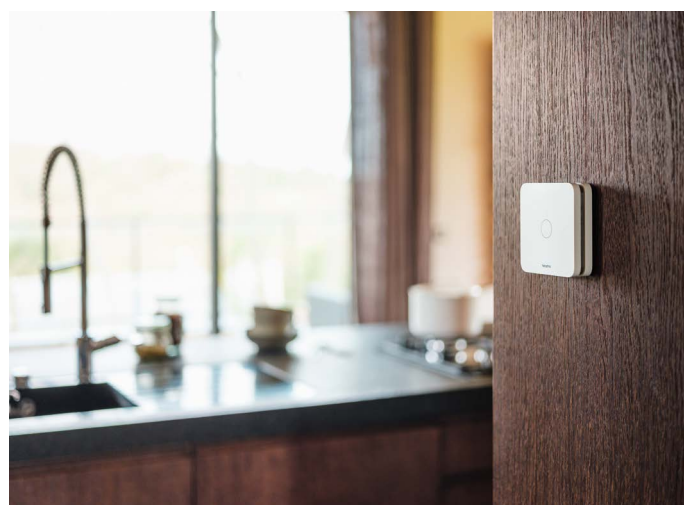

2 WIRES SYSTEM

Internal units

SPRINT L2

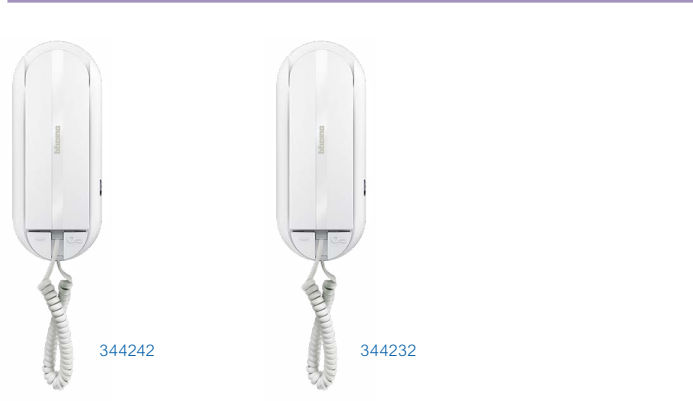

Item	Sprint L2 audio handsets
344242	2 WIRE audio handset (without the possibility of fitting with accessories) for audio systems and mixed audio / video systems. Wall mounted installation without the need of accessories. With door lock release key and auxiliary functions key (that can be configured). Ringtone volume adjustable on 3 levels. White
344232	As item 344242 but with call to the floor function

Universal analogue audio handset

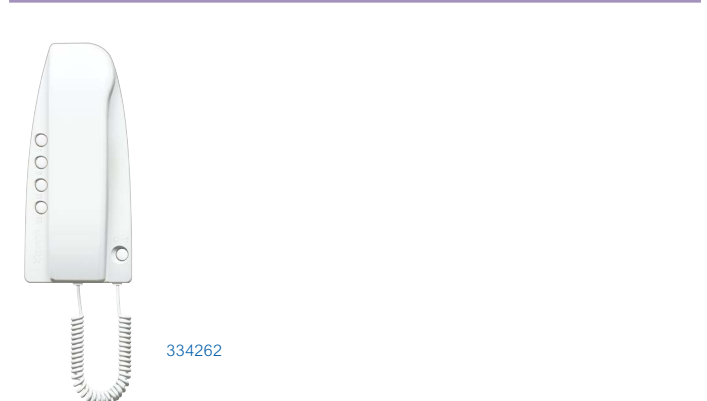

Item	Universal analogue audio handset
334262	Universal audio handset that can be installed in BTicino analogue (1 + n) and (4 + n) systems. Compatible with most competitors analogue systems. It has a lock release button and it is designed for the installation of 4 buttons accessory (Item 337430) for additional functions. Volume adjustment on 3 levels.

Dimensional data

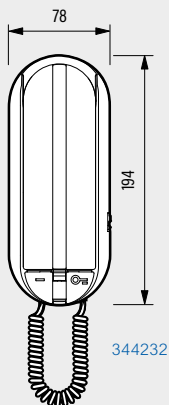

Size in mm



1 Simple and modern design



2 Ringtone volume, adjustable to 3 levels



3 Two pushbuttons:
- door lock release
- available for applications
(e.g. control of staircase lights)

Internal units

Porter switchboards



346310



SP122



346300

Item **Switchboard and accessories**

346310 Switchboard for 2 WIRE audio and video systems. Allows access to various services (video door entry functions, door lock/staircase light management and apartment alarm monitoring) directly from the keypad or via the intuitive icon menu. The switchboard is supplied with an integrated table supporting frame and also features a 7" colour LCD display, receiver and speaker phone, dedicated keys for the main functions and keys which can be configured. The programming can be carried out directly from the device or via PC with TiSwitchBoardDevice software (supplied). The device can manage the phonics of the riser EP (i.e. wired downstream of interface **346851**); it cannot however manage the apartment EP (i.e. wired downstream of interface **346850**). The use of an additional power supply is recommended. It is possible to connect up to a max. of 16 switchboards (configured from 0 to 15).

336982 White 8-way socket for table top installation of switchboard item **346310**

336803 8 – Way cable with connector for the table top installation connection.

SP122 Spare part handset and cord for 2-wire table guard station **346310**.

Item **SOFTSWITCHBOARD software**

346300 Switchboard software for the management of audio and video door entry system calls. The software (Windows operating system compatible) can be installed on any desktop or laptop PC, and gives the possibility of receiving, managing and transferring the calls from the entrance panel and the handset. It implements home video monitoring, with cyclical display of the cameras, night and day functions, and the possibility of displaying the alarms in the various apartments.
 - Supported operating systems:
 Microsoft Windows XP Service Pack 2, Windows Vista and Windows 7.
 - Software required:
 NET Framework 3.5 or higher

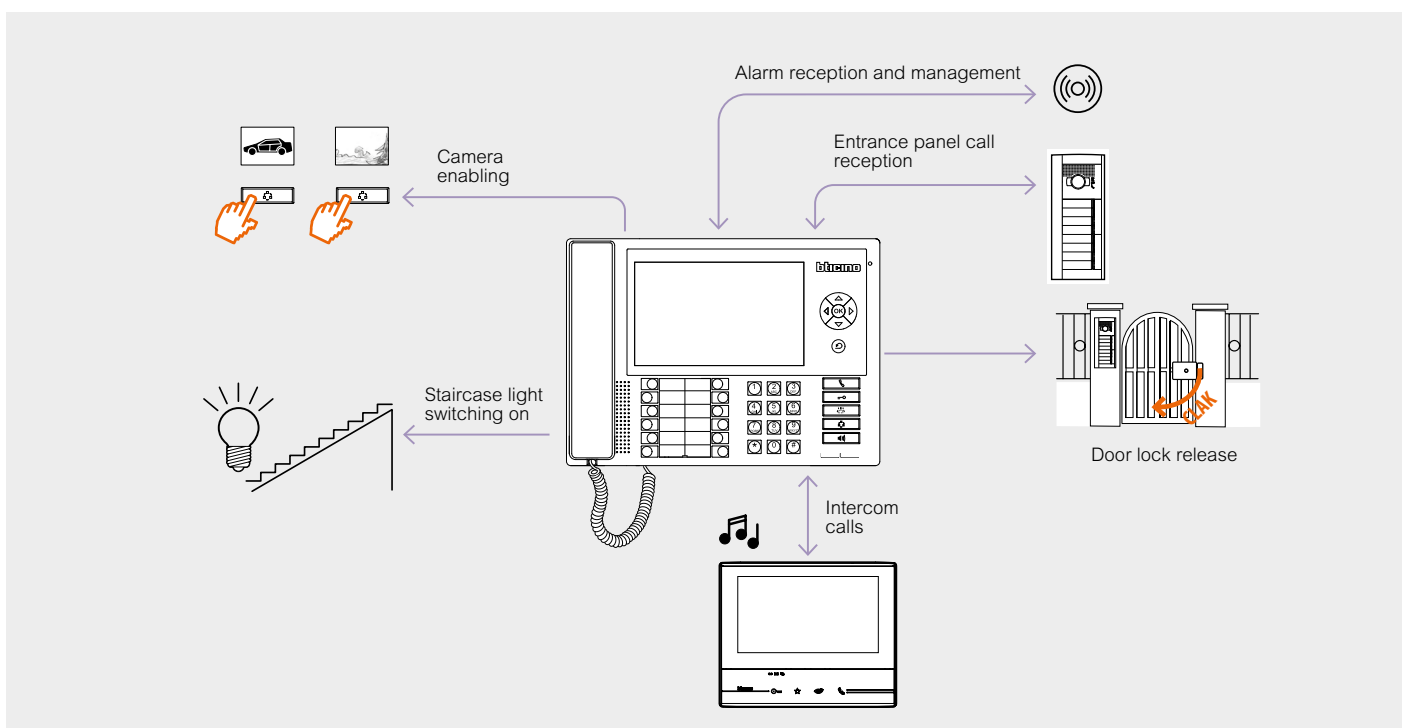

SYSTEM ACCESSORIES RANGE



System accessories

Accessories



346050 SELV



346030 SELV

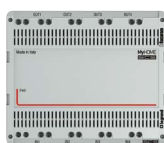

F441



346850



346851



346040 SELV



346020 SELV

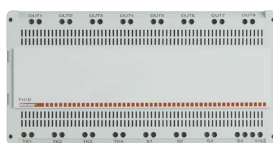

F441M

Item	Power supplies
346050	Power supply for 2 WIRES system in 6 DIN modular enclosure. Power supply 110 – 240 Vac @ 50 – 60 Hz. The output provides two power supplies in very low safety voltage (one on the 3 TK BUS, IU BUS and SCS clamps, one on the 1 - 2 clamp) to be used alternately and NOT at the same time. To be used in audio, video or mixed audio video systems. The video adapter is integrated in the device (item 346830 must not be used). It is therefore possible to avoid the use of the A/V node (F441) or the Multi-channel Matrix (F441M), if three junctions (MAX 2 IU + 1 TK risers or 1 IU + MAX 2 TK risers) are not exceeded in total from the clamps. It can also be used as additional power supply (1 - 2 output) for the local power supply of the preset internal units or entrance panels (in this case it is not possible to use other outputs). The device is electronically protected against overload and short circuit. It is a SELV double insulation safety device. The installation must be made in compliance with current regulations. The device must not be configured. WARNING: the (IU BUS), (TK BUS) and (SCS) outputs can be used at the same time respecting the total maximum absorption of 1.2 A. WARNING: Disconnect the power supply for 5 minutes after overload or short circuit.
346040	Power supply for 2 WIRES audio systems in 6 DIN modular enclosure. Power supply 110 – 240 Vac @ 50-60 Hz. The output provides 26 Vdc low rated voltage, and a maximum rated current of 600 mA and it is protected on the PRI side (with fuse) against overload and short circuit. It is a SELV double insulation safety device.
346030	Mini power supply with integrated video adapter to make small 2-WIRES video systems (intercom). 2 DIN modular enclosure. Power supply 230 Vac @ 50-60 Hz. The output provides 27 Vdc continuous low voltage, with maximum current of 600 mA and it is protected on the PRI side (with fuse) against overload and short circuit. It is a SELV double insulation safety device.
346020	Additional power supply to be used to supply the set up entrance panels and internal units locally. 2 DIN modular enclosure. Power supply 230 Vac @ 50-60 Hz. The output provides 27 Vdc continuous low voltage, with maximum current of 600 mA and it is protected on the PRI side (with fuse) against overload and short circuit. It is a SELV double insulation safety device.

Item	Video mixers
F441	Audio video node in 6-DIN modular enclosure set up with 4 input terminals and 4 output terminals. Can connect up to 4 source devices (entrance panels or cameras) in input and up to 4 2-WIRES video risers in output. The device must be used with the system power supply 346000. It must be used as an alternative to the audio video adapter 346830
F441M	Multi-channel matrix in 10 DIN modular enclosure. Set up for the connection of video entry system entrance panels, cameras and sound system sources in input and internal units and amplifiers in output. 4 inputs are dedicated to entrance panels/cameras and 4 to the sound system sources. It can be used to create multi-channel sound systems. The device must be used with the system power supply 346000. In the systems it replaces the video adapter 346830 and the audio video node F441
System interfaces	
346850	Apartment interface in 4 DIN modular enclosure. Can interface a dedicated apartment video door system with local CCTV, sound system and control of the Home automation applications to a 2-WIRES riser. The device must be configured using physical configurators
346851	System expansion interface in 4 DIN modular enclosure. Can double the length of the entrance panel-internal unit line, create risers with independent sound and expand the performance of the apartment system. The device must be configured using physical configurators

2 WIRES SYSTEM

System accessories

Accessories



346260



346210



346841



347400



346870



346993



346250



3499



354000

Item	Interfaces with other BTicino systems
346150	8/2-WIRES interface in 6 DIN modular enclosure. Can make mixed video door entry systems (8-WIRES digital backbone/2-WIRES risers). The device must be configured using physical configurators
349410	Analogue/2 WIRES interface in 4 DIN modular enclosure. Can interface a dedicated apartment 2-WIRE video door entry system with cameras and control of the MyHOME applications to an analogue riser, digital 8-WIRES, audio TERSYSTEM and VIDEOPORTER 2000.
DIN actuators	
346210	Relay actuator in 2 DIN modular enclosure. Can switch on lights, open gates, repeat the call on bells (MOD=SLA) or control other devices from the video internal units. The device must be configured using physical configurators
346230	Door lock relay actuator in 2 DIN modular enclosure. Can supply power and activate an electrical door lock. The device must be configured using physical configurators
346260	Timed door lock relay actuator in 4 DIN modular enclosure. Can switch on lights, open gates or manage electro-magnetic door locks, timed door opening and door lock status (with NC contact). The device must be configured using physical configurators

Item	Devices in basic enclosure
346841	Floor shunt with 4 outputs Can make 2-WIRES video door entry systems with star wiring distribution. The device automatically adapts the video signal. Its small size means it can also be placed inside the flush-mounted box
346833	Call to the floor interface. By connecting a traditional pushbutton, the following functions will be possible: general call to the floor, addressed call to the floor, staircase lights on, and door lock release (specific actuator needed) and association of the video image to the call to the floor. The device must be configured using physical configurators
347400	Interface for the conversion of the coaxial signal into a 2 WIRES BUS signal. It can be used to connect to the BUS of the 2 WIRES video door entry system a camera with coaxial video output powered at 12 Vdc, with maximum absorption 150 mA and 1 Vpp video output (75 Ω). The device must be configured using physical configurators
Wiring accessories	
346870	2 WIRES video amplifier. In video systems wired using non-twisted wires, where the distance between the entrance panels and the internal unit exceeds 50 metres, it enables increasing such distance to up to 100 metres
346250	Relay module for gate opening to be used with LINEA 2000, LINEA 3000, MINISFERA and SFERA pushbutton panels. Can open door locks (NOT managed by BUS) by means of the entrance panel
3499	Line terminator. To be used to terminate the riser or apartment line, when the last installed device is not fitted with line closing micro switch
354000	Flat cable for the connection of several SFERA NEW and SFERA ROBUR pushbutton modules. Length 470 mm

System accessories

Accessories



346991



346994

 336904
336905

3515



3501/1



3501K

Item	Universal speaker unit and expansion module
346991	The universal speaker unit can be used to install the 2 WIRES audio system in new or refurbished systems, where pushbutton panels of other manufacturers are present or required (mail boxes, patterned brass, compact sheet metal units, etc.), preset for a traditional speaker module (e.g. 2659N). The universal speaker unit has, as base, contacts for the connection of 8 call keys; to make systems with more keys (up to 56 using the 346000 power supply and up to 24 with the 346010 power supply one or more key expansion modules must be used (1 every 8 pushbuttons).
346992	Expansion module for connecting more than 8 call keys to item 346991 - max. 6 modules (56 calls max.) with power supply 346000. Max. 2 modules (24 calls max.) with power supply 346010

Item	Universal speaker unit with built-in relay
346994	Universal speaker unit with built-in relay (for controlling an electric door lock), designed for the installation of the 2-WIRES audio system in both new and refurbished setups where "special" pushbutton panels are present or required (such as mailboxes, patterned brass, compact sheet metal units, etc.) that are pre-configured for a traditional speaker module (e.g., 2659N). The universal speaker unit includes terminals for connecting up to 4 call pushbuttons and 1 local door release pushbutton. For systems with more than 4 call pushbuttons, it is necessary to add item 346993, with 1 unit required for every 8 pushbuttons (up to a maximum of 100 pushbuttons). The multi-cable with 2 connectors supplied with item 346993 must be used for the connection. Microphone sensitivity and speaker volume can be adjusted using dedicated potentiometers. The microphone of the speaker unit can be detached and placed at a distance of up to 15 cm from the device. In video systems, the device must be paired with cameras featuring coaxial output using interface 347400.

Item	Cable for systems
336904	Specific cable for 2 WIRES video door entry applications with 2 twisted conductors. It can be installed in underground piping, in accordance with standards (CEI 20-13 and CEI 20-14). It ensures the best performance in video systems (higher distance between EP and Handset when compared with other cables). 200 m coil
336905	Specific cable for BUS / SCS unshielded, consisting of a white outer sheath and 2 flexible conductors twisted together with a cross section of 0.50 mm ² . Halogen-free low-toxicity cable; ideal for applications in environments where greater regard is required for safety in the event of fire (halogen free). 400 V insulation. Compliant with standards: EN 50575 EN60811, EN50289, EN50290, EN60228, 50265-2-1, EN50395, EN50396. Cable not suitable for burial. Coil length 200 m. Fire reaction class according to CPR regulation: Ccas1b, d1, a1.

Item	Spare part terminal/clamp
3515	Spare part terminal/clamp for BUS connection of the predisposed devices

Item	Configurators (package of 10 pieces)
3501/0	Configurator 0
3501/1	Configurator 1
3501/2	Configurator 2
3501/3	Configurator 3
3501/4	Configurator 4
3501/5	Configurator 5
3501/6	Configurator 6
3501/7	Configurator 7
3501/8	Configurator 8
3501/9	Configurator 9
3501/JMP	Configurator JMP

Item	Configurator kit
3501K	Configurator kit consisting of: - 10 pieces for each type of configurator from 0 to 9 - 4 green removable 2-clamp connectors - 1 configurator connection tool (3502) - 1 plastic screwdriver

Example - Wiring diagram

Audio system

Example of multi-family audio system

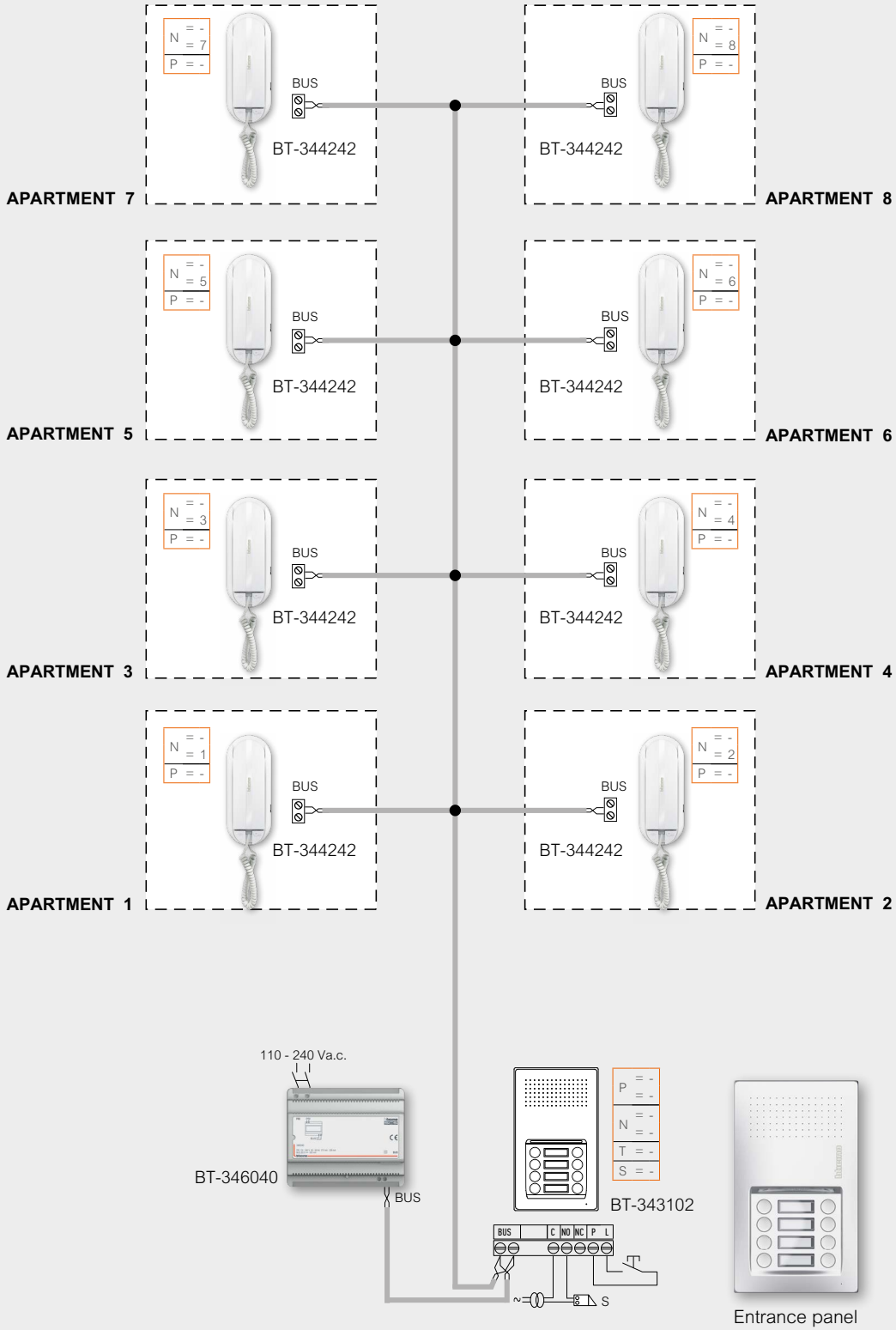

Example - Wiring diagram

Video system

Example of multi-family video system

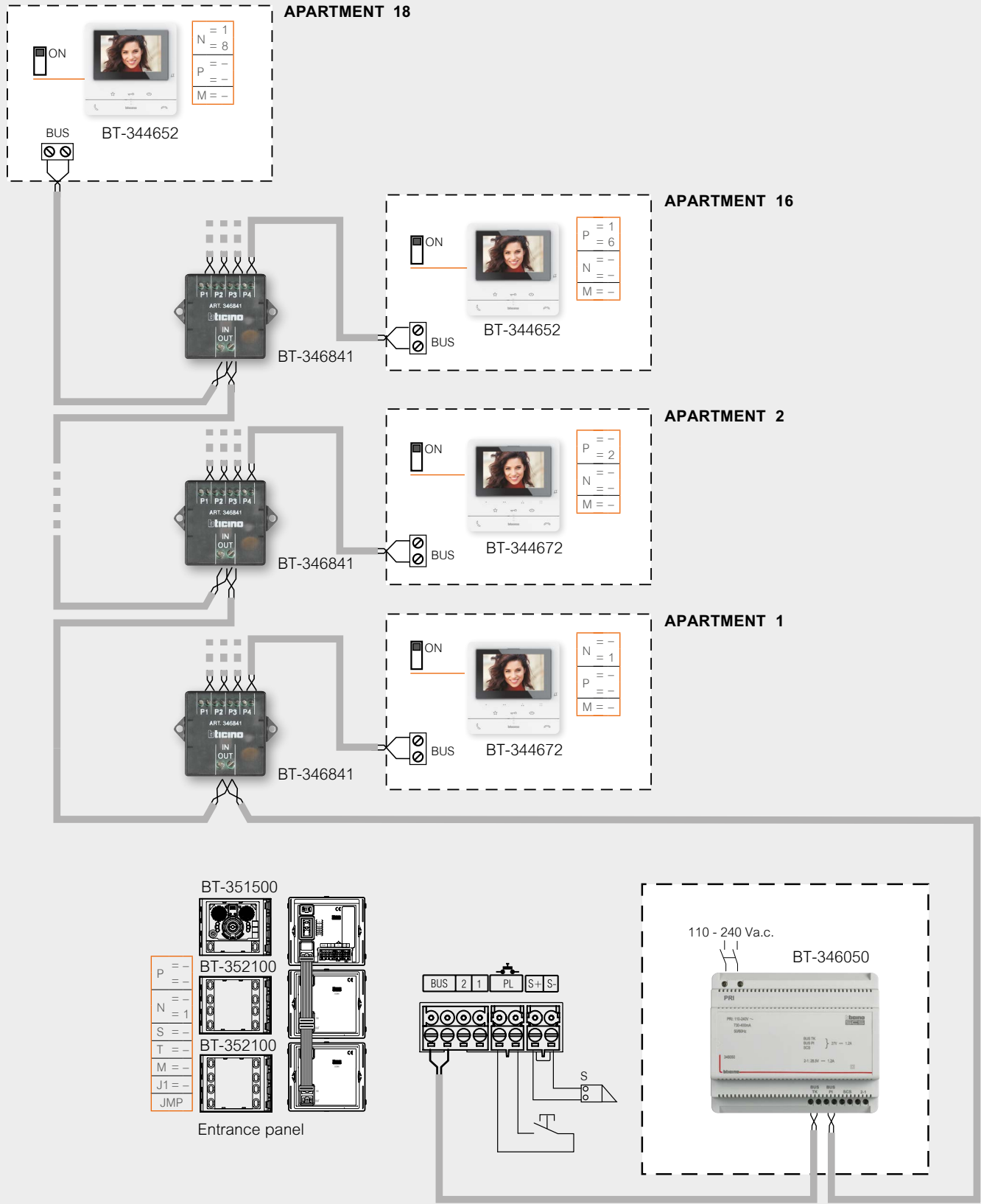

IP SYSTEM

IP SYSTEM

Video door entry system



IP SYSTEM

For the best performance

The perfect solution for large residential complexes with a high number of apartments, able to guarantee high performance, long distances and high video signal quality.



Wide range of products with flexible and scalable solutions to satisfy every building needs.



Entrance panel



Video indoor unit



Guard station



reddot winner

MAIN PERFORMANCES AND FUNCTIONALITIES

Multichannel: for simultaneous conversations (no busy lines);

High definition video quality: up to 1280 x 720;

Technology: IP protocol (SIP/TCP);

Cables: FTP and UTP (CAT5 - CAT5E - CAT6) - Fiber optic

Configuration: easy and quick configuration with dedicated software;

Integration: Onvif IP Cameras, Lift control, Alarm sensors;

App Home + Security: incoming calls answering and door locks activation by smartphone;

App Home + Control: Smart Home & Home Automation integration.

Multiple ways to CALL THE APARTMENT

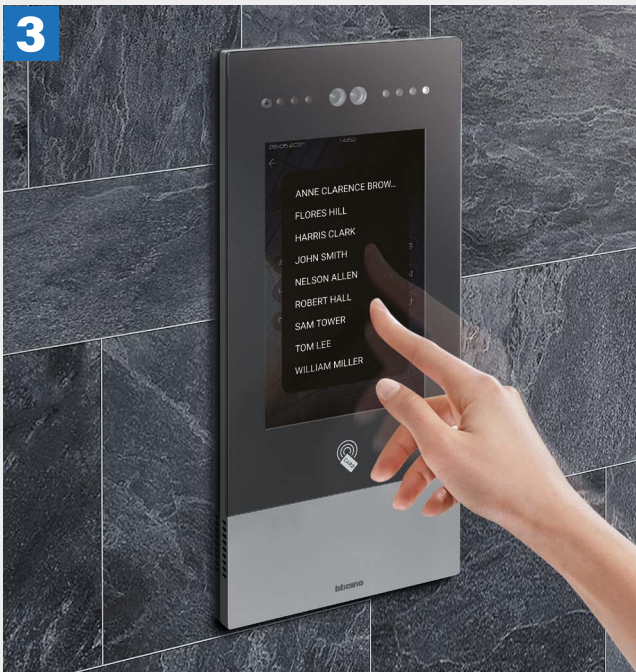
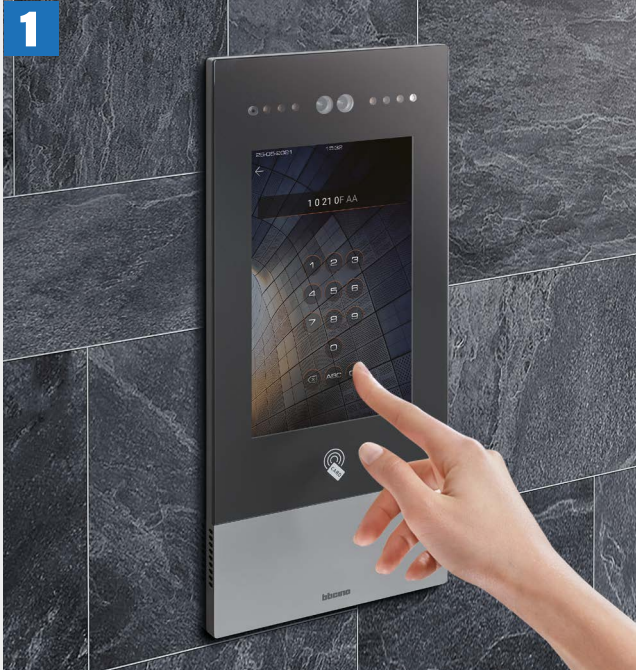

- 1. STANDARD CALL**
Area-Building-Riser
Floor-Apartment
- 2. ALPHANUMERIC CALL**
Create codes
with numbers and letters
- 3. ADDRESS BOOK**
With contact list
(touch displays only)

ACCESS

the building in several ways



FACE RECOGNITION

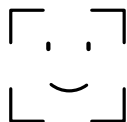

FINGERPRINT



RFID CARD AND BADGE

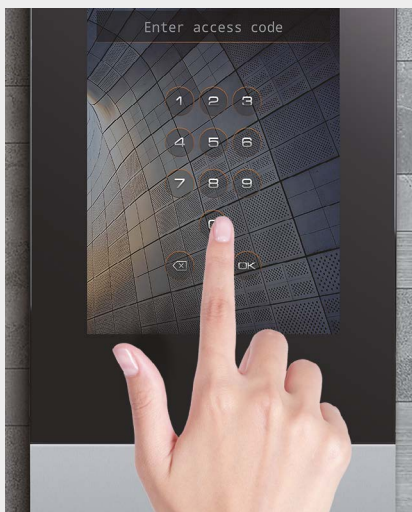

ACCESS CODE

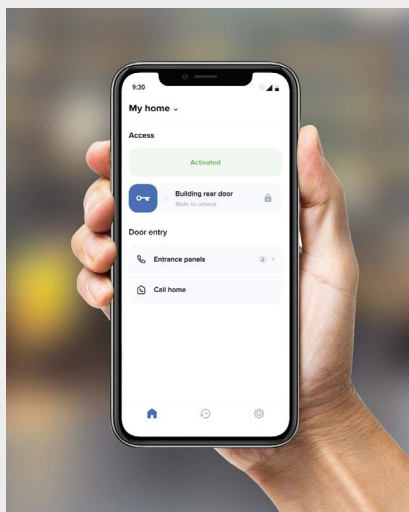
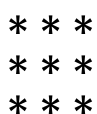

SMARTPHONE



HOME + SECURITY



Always aware with the Home + Security App

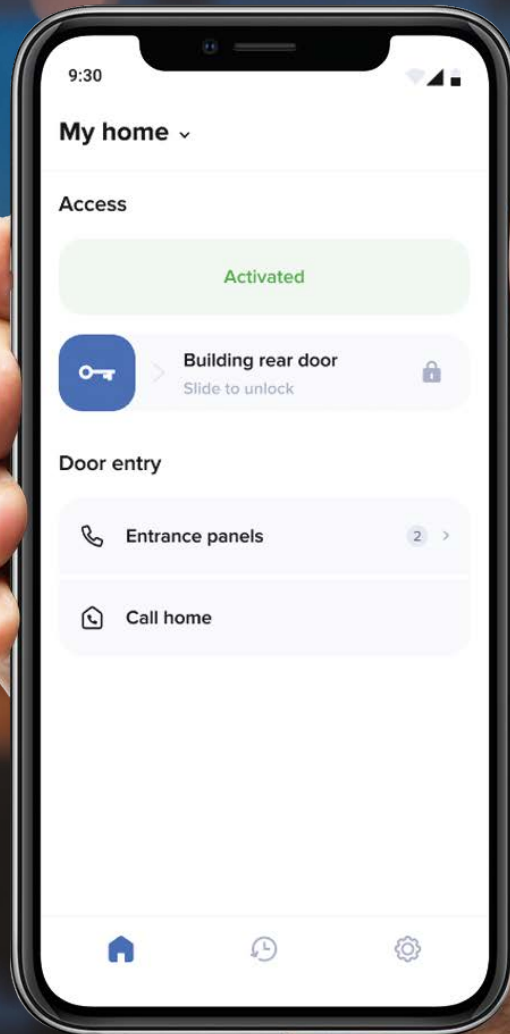

THE BEST APP FOR A SAFE HOME

Alerts and notifications for incoming calls, motion and people detection, event information and door lock management with a simple and intuitive interface.

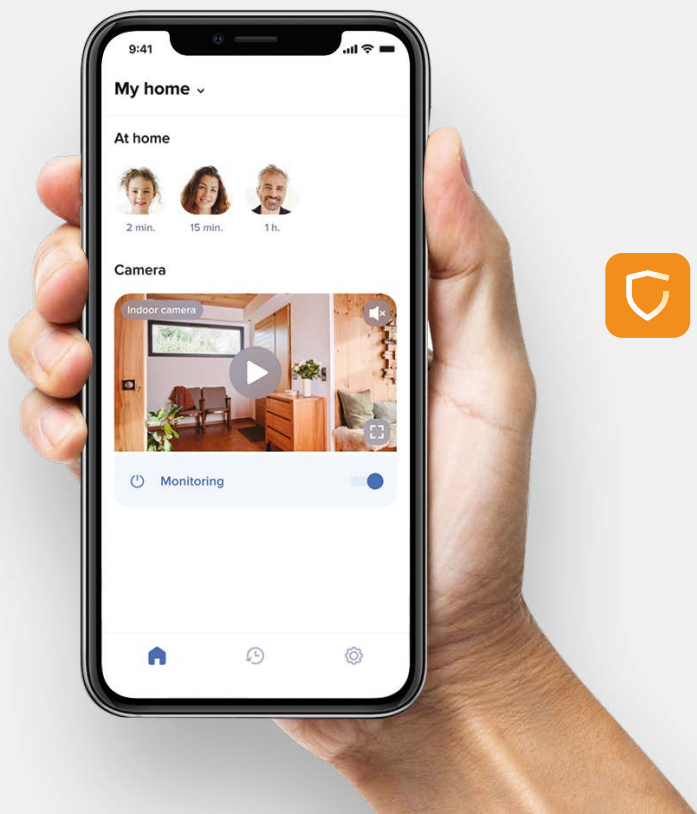

Home + Security
The best App for a safe home.

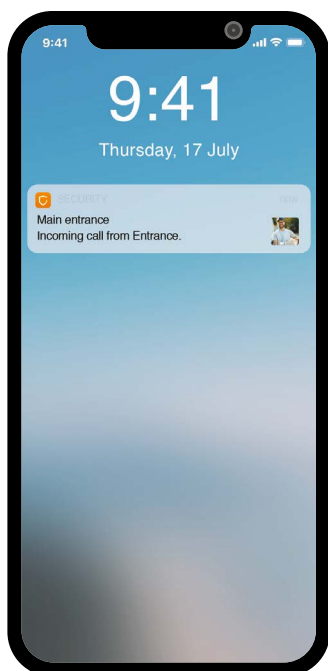

INCOMING CALL

Receive notification when someone is calling

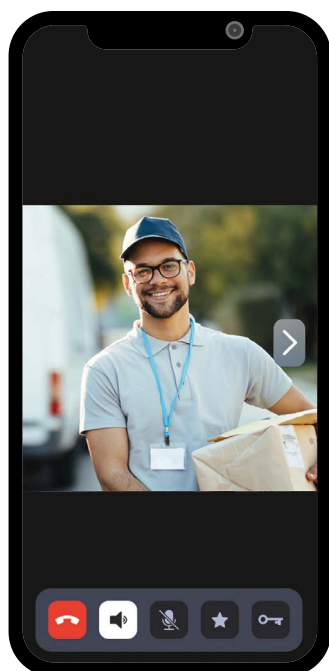

SEE WHO'S CALLING

Answer the call and open the gate for the courier

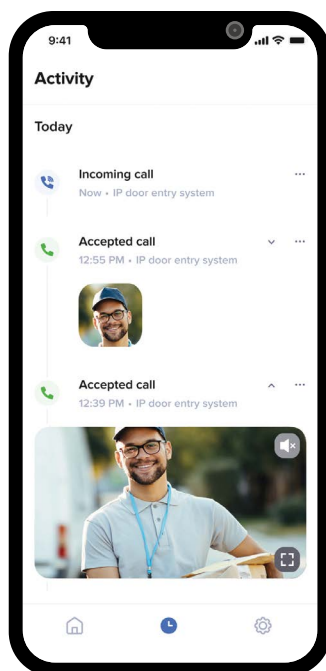

CHECK THE EVENTS

Check who called you and if they left you a message

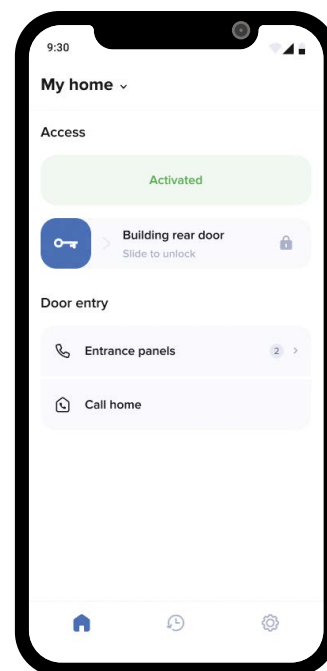

QUICK ACTIONS

- Activate the electrical door locks
- Call home
- Activate the cameras
- Manage the answering machine



Your home under control with the Home + Control App

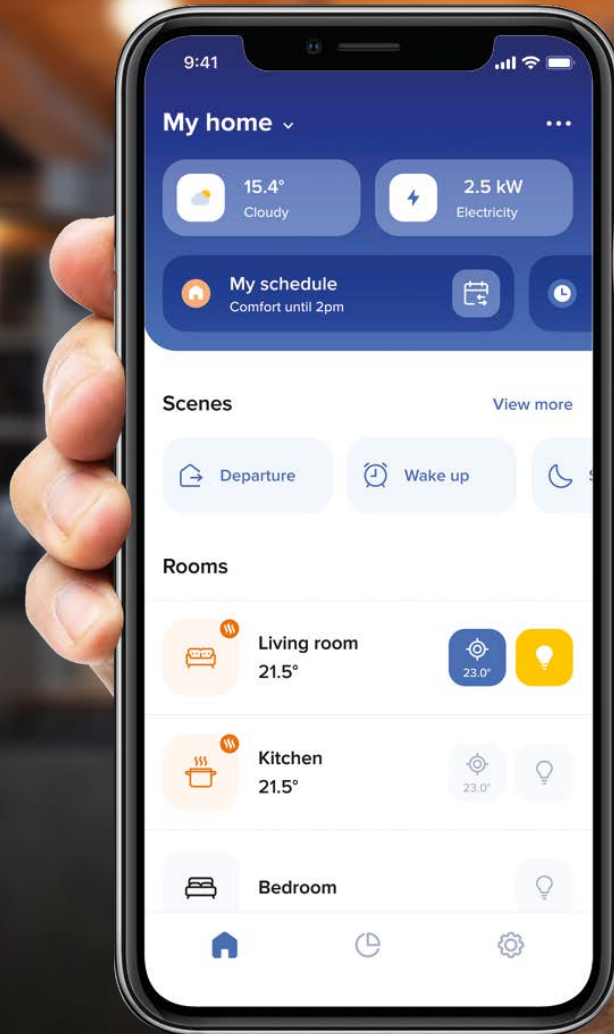

ONE APP: EFFORTLESS COMFORT AND SMART SAVINGS

Control lights, shutters, energy usage, temperature and electrical vehicle. Create personalized scenarios for your comfort and efficiency.



Home + Control The best App for the Smart Home.

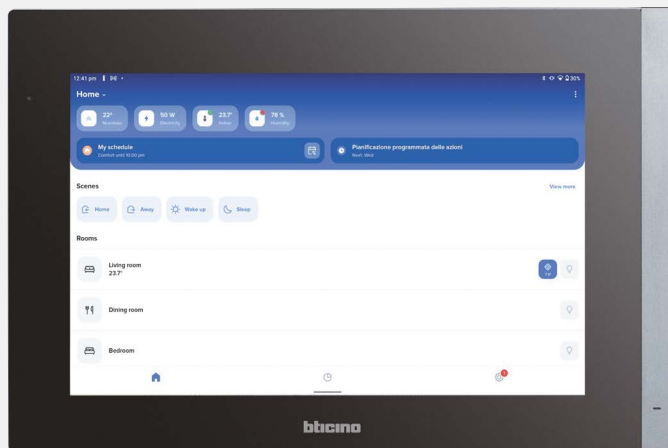
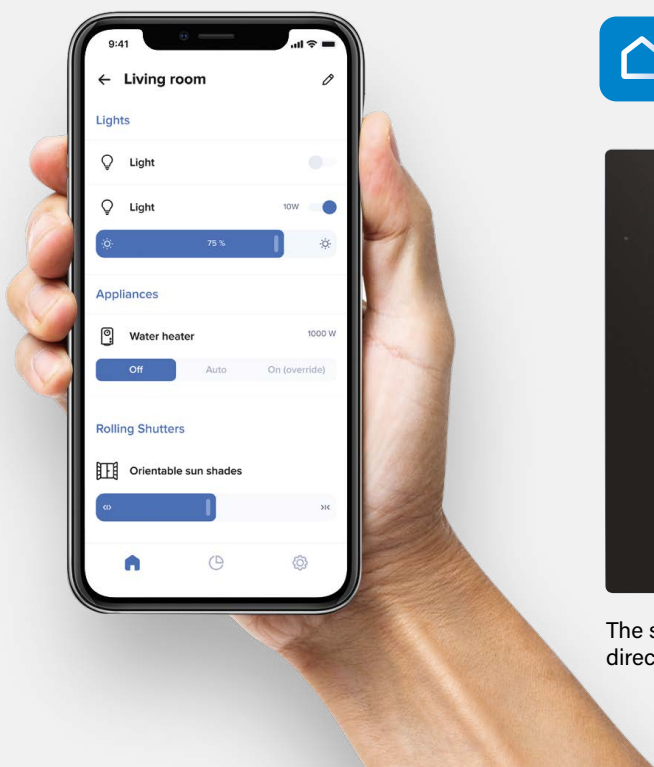

The same user interface as the H + C App is now also available directly on the screen of the 373103 and 373104 video indoor units.

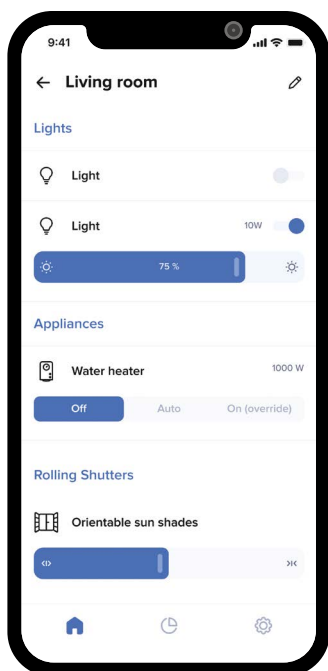

SIMPLIFIED CUSTOMIZATIONS

Manage your home according to your needs through the creation of scenarios, scheduling and automations.

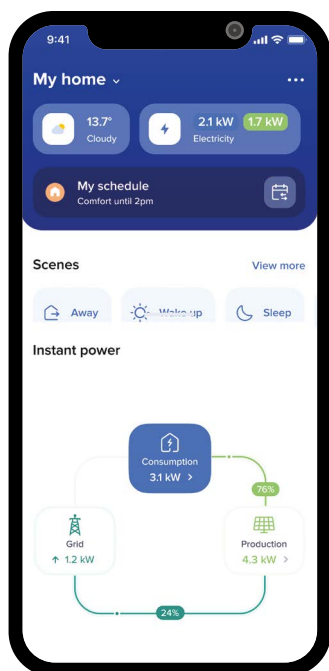

ADVANCED ENERGY MANAGEMENT

Set load priorities, track energy usage, and access reports to view monthly costs, top-consuming appliances, and more.

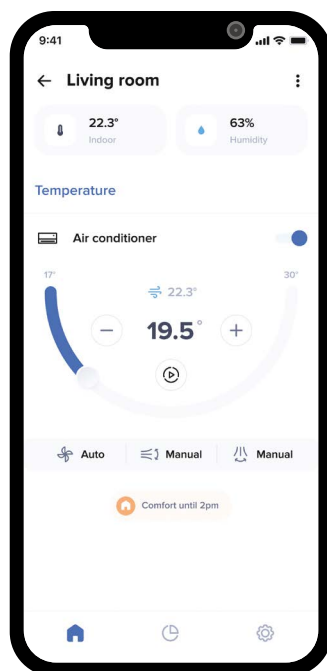

HOME TEMPERATURE MANAGEMENT

Set and schedule temperatures for heating and cooling. Create weekly programs and manage smart functions.

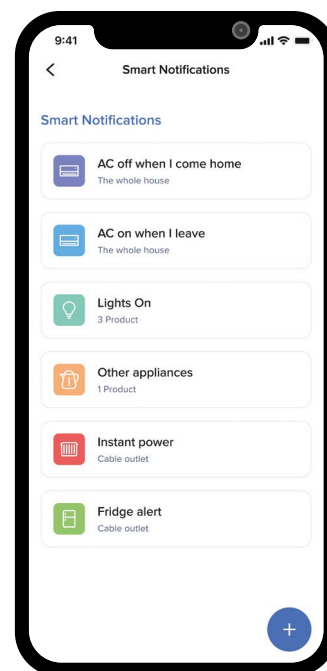

SMART NOTIFICATIONS

Receive notifications about key events, such as lights left on or power loss.

Integrations

Integrate with ONVIF IP cameras

From the Guard Station it is possible to monitor all the common area IP cameras, while from the indoor units, the resident can monitor private and common area Onvif IP cameras.



Guard station



Indoor unit

Integrate with lift control

Thanks to the access control function, visitors are taken directly to the floor of the called apartment.



NOTE: integration to be performed through Lift Control interface with protocol translator (375010) or with relays (375013).

The main devices

ENTRANCE PANELS	10inch TOUCH DISPLAY	4.3inch DISPLAY WITH KEYPAD	SMALL ENTRANCE PANELS				
------------------------	-----------------------------	------------------------------------	------------------------------	--	--	--	--



374000



374002



374001



374003



374004



374006



374007



374005

Colour video	■	■	■	■	■	■	■	■
Finishes / Colours	Grey	Grey	Grey	Grey	Grey	Black	Black	Grey
Flush mounted installation	With accessory 375007	With accessory 375007	With accessory 375006	With accessory 375006	With accessory 375008			With accessory 375009
Capacitive button call			■	■	■	■		
Touch display	■	■						■
Keypad			■	■				
Direct call to apartment	■	■			■	■	■	■
3D Face recognition	■		■					■
Fingerprint reader	■		■					
RFID Badge reader	■	■	■	■	■	■	■	■
Protection index	IP54	IP54	IP54	IP54	IP54	IP54	IP54	IP54
Protection index against mechanical impact	IK07	IK07	IK07	IK07	IK07	IK07	IK07	IK07
Rainshield						■	With accessory 375015	
Angular installation							With accessory 375016	
Power supply	375005 375002	375005 375002	375005 375002	375005 375002	375005 375002	375005 375002	Standard PoE 375005 375002	375005 375002

Entrance panels

catalogue



Item Video entrance panels

- 374000** **Video entrance panel with 10" touch display, double face recognition camera, fingerprint reader and badge reader for access control functions.**
 From the touch display, it is possible to make calls to the apartments and the guard station and enter the access code to release the lock. Configuration of different calling modes:
 - Apartment code (Area - Building - Riser - Floor - Apartment)
 - Numeric or alphanumeric codes for residents
 - Address book with contact list
 Enter the settings menu with a specific code for maintenance and for managing the settings (e.g. backlight brightness, ring volume, speaker volume, touch volume, screensaver time). Possibility to upload customized screensavers and advertisements using the configuration software. The entrance panel can be PoE (power over Ethernet) powered, or directly powered using power supply **375005**. **Flush mounted installation using the dedicated box (A)-375007.**
- 374002** **Video entrance panel with 10" touch display and badge reader for access control functions.**
 From the touch display, it is possible to make calls to the apartments and the guard station and enter the access code to release the lock. Configuration of different calling modes:
 - Apartment code (Area - Building - Riser - Floor - Apartment)
 - Numeric or alphanumeric codes for residents
 - Address book with contact list
 Enter the settings menu with a specific code for maintenance and for managing the settings (e.g. backlight brightness, ring volume, speaker volume, touch volume, screensaver time). Possibility to upload customized screensavers and advertisements using the configuration software.
 The entrance panel can be PoE (power over Ethernet) powered, or directly powered using power supply **375005**. **Flush mounted installation using the dedicated box (A)-375007.**
- 374001** **Video entrance panel with 4.3" display, keypad with numbers and letters (A-I), double face recognition camera, fingerprint reader and badge reader for access control functions.** Using the keypad, it is possible to make calls to the apartments and the guard station and enter the access code to release the lock. Configuration of different calling modes:
 - Apartment code (Area - Building - Riser - Floor - Apartment)
 - Numeric or alphanumeric codes for residents
 Enter the settings menu with a specific code for maintenance and for managing the settings (e.g. backlight brightness, ring volume, speaker volume, button volume, screensaver time). Possibility to upload customized screensavers using the configuration software. The entrance panel can be PoE (power over Ethernet) powered, or directly powered using power supply **375005**. **Flush mounted installation using the dedicated box (B)-375006.**

Item Video entrance panels

- 374003** **Video entrance panel with 4.3" display, keypad with numbers and letters (A-I) and badge reader for access control functions.**
 Using the keypad, it is possible to make calls to the apartments and the guard station and enter the access code to release the lock. Configuration of different calling modes:
 - Apartment code (Area - Building - Riser - Floor - Apartment)
 - Resident's alphanumeric code
 Enter the settings menu with a specific code for maintenance and for managing the settings (e.g. backlight brightness, ring volume, speaker volume, touch volume, screen saver time). Possibility to upload customized screensavers and advertisements using the configuration software.
 The entrance panel can be PoE (power over Ethernet) powered, or directly powered using power supply **375005**. **Flush mounted installation using the dedicated box (B)-375006.**
- 374004** **Small video entrance panel for indoor installation with badge reader and key for indoor unit and guard station calls.** The small video entrance panel can be PoE (power over Ethernet) powered, or directly powered using power supply **375005**. **Flush mounted installation using the dedicated box (C)-375008.**
- 374005** **Small video entrance panel with 4.3" vertical touch display, face recognition and badge reader for access control functions.**
 From the touch display, it is possible to make calls to the apartments and the guard station and enter the access code to release the lock. Configuration of different calling modes:
 - Apartment code (Area - Building - Riser - Floor - Apartment)
 - Numeric or alphanumeric codes for residents
 - Address book with contact list
 Settings menu for maintenance and for managing settings (e.g. backlight brightness, ring volume, speaker volume, touch volume, screensaver time). Possibility to upload customized screensavers using the configuration software. This device can be PoE (power over Ethernet) powered, or directly powered using power supply **375005**. **Flush mounted installation using the dedicated box (D)-375009.**
- 374006** **Small video entrance panel** with RFID badge reader and physical button for calls. The small video entrance panel can be PoE (power over Ethernet) powered, or directly powered using power supply **375005**. **Wall mounted installation thanks to the support with rainshield included.**
- 374007** **Small video entrance panel** with RFID badge reader and physical button for calls. The small video entrance panel can be PoE (power over Ethernet) standard IEEE 802.3af, PoE 24V using item **375002** or directly powered using power supply **375005**. **Wall mounted installation with bracket included, to be completed if needed with rainshield accessory (375015) and angular mounting accessory (375016).**

(A) - (B) - (C) - (D) - Correspondence with the specific flush-mounted box - see accessories page.

The main devices

PREMIUM INDOOR UNITS	10inch TOUCH DISPLAY		7inch TOUCH DISPLAY	
-------------------------------------	-------------------------	--	------------------------	--



373001



373103



373002



373104

Touch screen colour video	▪	▪	▪	▪
Handsfree	▪	▪	▪	▪
Finishes / Colours	Grey	Grey	Grey	Grey
Display	LCD 10inch	LCD 10inch	LCD 7inch	LCD 7inch
Indoor camera	▪		▪	
Answering machine	▪	▪	▪	▪
Alarm management	▪	▪	▪	▪
Wi-Fi connectivity		▪		▪
Smart Home control		▪		▪
SOS function	Physical button	Physical button	Physical button	Physical button
Door lock release	▪	▪	▪	▪
Entrance panel camera activation	▪	▪	▪	▪
Intercom	▪	▪	▪	▪
Integration with Home+Security app	▪	▪	▪	▪
Audio messages	▪	▪	▪	▪
Type of installation	Wall mounted	Wall mounted	Wall mounted	Wall mounted
Power supply	375005 375002	Standard PoE 375005 375002	375005 375002	Standard PoE 375005 375002

**STANDARD
INDOOR
UNITS**

7inch
TOUCH DISPLAY



373005



373006



373007



373008

Touch screen colour video	▪	▪	▪	▪
Handsfree	▪	▪	▪	▪
Finishes / Colours	Black	Champagne Gold	Mirror	Black
Display	LCD 7inch	LCD 7inch	LCD 7inch	LCD 7inch
Indoor camera				
Answering machine	▪	▪	▪	▪
Alarm management	▪	▪	▪	▪
SOS function	(On screen button)	(On screen button)	(On screen button)	(On screen button)
Door lock release	▪	▪	▪	▪
Entrance panel camera activation	▪	▪	▪	▪
Intercom	▪	▪	▪	▪
Integration with Home + Security app	▪	▪	▪	▪
Audio messages	▪	▪	▪	▪
Type of installation	Wall mounted	Wall mounted	Wall mounted	Wall mounted
Power supply	375005 375002	375005 375002	375005 375002	Standard PoE

Premium indoor units

catalogue

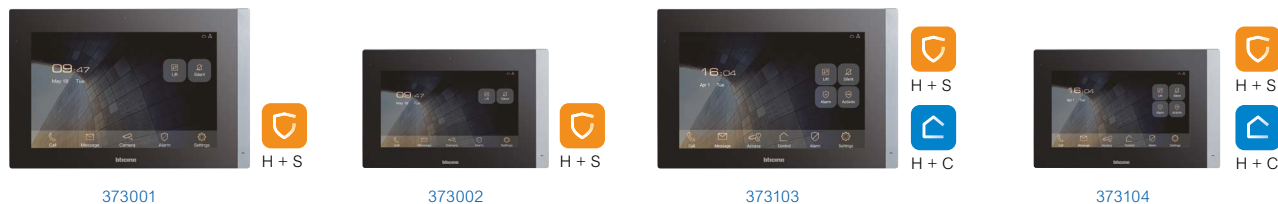

373001

373002

373103

373104

Item	Video indoor unit	Item	Video indoor unit with Smart Home integration
373001	<p>10" touch display premium indoor unit with internal camera and SOS pushbutton.</p> <p>From the touch display, it is possible to answer the call, open the lock, call the other apartments and the guard station, view call and alarm logs, leave audio messages, receive messages from the guard station, adjust the settings (e.g. brightness, screensaver, backgrounds and ringtone) and view date/time information. Alarm management can be easily integrated thanks to 8 pre-arranged dedicated contacts. The integration with the Onvif IP cameras allows to view the IP cameras of the apartment and the common areas from the indoor unit. The specific integration also allows control of the lift. It is possible to associate the video indoor unit to the Home + Security App (available for Android and iOS). The App allows to use functions such as: receiving calls, door lock release, display of the event timeline and activation of the entrance panel. With the Home + Security App, it is also possible to manage the products of the Netatmo range. This allows you to quickly and easily create a Smart security system. The indoor unit can be PoE (power over Ethernet) 24 V using item 375002, or directly powered using power supply 375005. Wall mounted using the supplied bracket.</p>	373103	<p>10" Touch display premium indoor unit Wi-Fi with Smart Home integration and SOS pushbutton.</p> <p>From the touch display, it is possible to answer the call, open the lock, call the other apartments and the guard station, view call and alarm logs, leave audio messages, receive messages from the guard station, adjust the settings (e.g. brightness, screensaver, backgrounds and ringtone) and view date/time information. You can manage Smart Home devices via the integrated Home + Control app (after installing the Gateway and/or MyHOME Server). Alarm management can be easily integrated thanks to 8 prearranged dedicated contacts. The integration with the Onvif IP cameras allow to view the IP cameras of the apartment and the common areas from the indoor unit. It is possible to control the lift thanks to a dedicated interface. It is possible to associate the video indoor unit to the Home + Security App (available for Android and iOS). The App allow to use functions such as: receiving calls, door lock release, display of the event timeline, activation of the entrance panel. With the Home + Security App, it is also possible to manage the products of the Netatmo range. This allows you to quickly and easily create a Smart security system. The indoor unit can be PoE (power over Ethernet) standard IEEE 802.3at, PoE 24V using ref 375002 or directly powered using power supply 375005. Wall mounted using the supplied bracket.</p>
373002	<p>7" touch display premium indoor unit with internal camera and SOS pushbutton.</p> <p>From the touch display, it is possible to answer the call, open the lock, call the other apartments and the guard station, view call and alarm logs, leave audio messages, receive messages from the guard station, adjust the settings (e.g. brightness, screensaver, backgrounds and ringtone) and view date/time information. Alarm management can be easily integrated thanks to 8 pre-arranged dedicated contacts. The integration with the Onvif IP cameras allows to view the IP cameras of the apartment and the common areas from the indoor unit. The specific integration also allows control of the lift. It is possible to associate the video indoor unit to the Home + Security App (available for Android and iOS). The App allows to use functions such as: receiving calls, door lock release, display of the event timeline and activation of the entrance panel. With the Home + Security App, it is also possible to manage the products of the Netatmo range. This allows you to quickly and easily create a Smart security system. The indoor unit can be PoE (power over Ethernet) 24 V using item 375002, or directly powered using power supply 375005. Wall mounted using the supplied bracket.</p>	373104	<p>7" Touch display premium indoor unit Wi-Fi with Smart Home integration and SOS pushbutton.</p> <p>From the touch display, it is possible to answer the call, open the lock, call the other apartments and the guard station, view call and alarm logs, leave audio messages, receive messages from the guard station, adjust the settings (e.g. brightness, screensaver, backgrounds and ringtone) and view date/time information. You can manage Smart Home devices via the integrated Home + Control app (after installing the Gateway and/or MyHOME Server). Alarm management can be easily integrated thanks to 8 prearranged dedicated contacts. The integration with the Onvif IP cameras allow to view the IP cameras of the apartment and the common areas from the indoor unit. It is possible to control the lift thanks to a dedicated interface. It is possible to associate the video indoor unit to the Home + Security App (available for Android and iOS). The App allow to use functions such as: receiving calls, door lock release, display of the event timeline, activation of the entrance panel. With the Home + Security App, it is also possible to manage the products of the Netatmo range. This allows you to quickly and easily create a Smart security system. The indoor unit can be PoE (power over Ethernet) standard IEEE 802.3at, PoE 24V using ref 375002 or directly powered using power supply 375005. Wall mounted using the supplied bracket.</p>

Standard indoor units

catalogue



373005



373006



373007



373008

Item	Video indoor unit
373005	<p>7" touch display standard indoor unit, black finishing.</p> <p>From the touch display, it is possible to answer the call, open the lock, call the other apartments and the guard station, view call and alarm logs, leave audio messages, receive messages from the guard station, adjust the settings (e.g. brightness and ringtone) and view date/time information. Alarm management can be easily integrated thanks to 8 pre-arranged dedicated contacts. The integration with the Onvif IP cameras allows to view the IP cameras of the apartment and the common areas from the indoor unit. The specific integration also allows control of the lift. It is possible to associate the video indoor unit to the Home + Security App (available for Android and iOS). The App allows to use functions such as: receiving calls, door lock release, display of the event timeline and activation of the entrance panel. With the Home + Security App, it is also possible to manage the products of the Netatmo range. This allows you to quickly and easily create a Smart security system. The indoor unit can be PoE (power over Ethernet) 24 V using item 375002 or directly powered using power supply 375005. Wall mounted using the supplied bracket.</p>
373006	<p>7" touch display standard indoor unit, champagne gold finishing.</p> <p>From the touch display, it is possible to answer the call, open the lock, call the other apartments and the guard station, view call and alarm logs, leave audio messages, receive messages from the guard station, adjust the settings (e.g. brightness and ringtone) and view date/time information. Alarm management can be easily integrated thanks to 8 pre-arranged dedicated contacts. The integration with the Onvif IP cameras allows to view the IP cameras of the apartment and the common areas from the indoor unit. The specific integration also allows control of the lift. It is possible to associate the video indoor unit to the Home + Security App (available for Android and iOS). The App allows to use functions such as: receiving calls, door lock release, display of the event timeline and activation of the entrance panel. With the Home + Security App, it is also possible to manage the products of the Netatmo range. This allows you to quickly and easily create a Smart security system. The indoor unit can be PoE (power over Ethernet) 24 V using item 375002 or directly powered using power supply 375005. Wall mounted using the supplied bracket.</p>

Item	Video indoor unit
373007	<p>7" touch display standard indoor unit, mirror finishing.</p> <p>From the touch display, it is possible to answer the call, open the lock, call the other apartments and the guard station, view call and alarm logs, leave audio messages, receive messages from the guard station, adjust the settings (e.g. brightness and ringtone) and view date/time information. Alarm management can be easily integrated thanks to 8 pre-arranged dedicated contacts. The integration with the Onvif IP cameras allows to view the IP cameras of the apartment and the common areas from the indoor unit. The specific integration also allows control of the lift. It is possible to associate the video indoor unit to the Home + Security App (available for Android and iOS). The App allows to use functions such as: receiving calls, door lock release, display of the event timeline and activation of the entrance panel. With the Home + Security App, it is also possible to manage the products of the Netatmo range. This allows you to quickly and easily create a Smart security system. The indoor unit can be PoE (power over Ethernet) 24 V using item 375002 or directly powered using power supply 375005. Wall mounted using the supplied bracket.</p>
373008	<p>7" PoE powered standard indoor unit, black finish</p> <p>From the touch display, it is possible to answer the call, open the lock, call the other apartments and the guard station, view call and alarm logs, leave audio messages, receive messages from the guard station, adjust the settings (e.g. brightness and ring tone), and view date/time information. Alarm management can be easily integrated thanks to 8 pre-arranged dedicated contacts. The integration with the Onvif CCTV IP cameras allows to view the IP cameras of the apartment and the common area from the indoor unit. The specific integration also allows control of the lift. It is possible to associate the video indoor unit to the Home + Security App (available for Android and iOS). The App allows to use functions such as: receiving calls, door lock release, display of the event timeline and activation of the entrance panel. With the Home + Security App, it is also possible to manage the products of the Netatmo range. This allows you to quickly and easily create a Smart security system. The indoor unit can be PoE (power over Ethernet) standard IEEE 802.3af. Wall mounted using the supplied bracket.</p>

Guard Station and accessories

catalogue



375000



375001



348200



348201



348202



348203



348204



348205



348206

Item	Guard station
375000	<p>Guard station with 10" touch display and handset. From the touch display, it is possible to: answer and transfer calls, view call logs, release the locks, monitor IP cameras installed in common areas, monitor and process alarms. From the setting menu, it is possible to adjust the guard station settings, like volume and display brightness, and carry out functionality and network tests. Quick and scheduled absence can be activated to transfer the call to another guard station or to apartments if needed. The guard station can be PoE (power over Ethernet) powered, or directly powered using power supply 375005.</p>



Item	Accessories
375001	<p>Server DES (Door Entry System) including configuration and management software must be installed in the building under the VLAN network of the IP door entry system. The configuration software IP DES PRO must be used to create, configure and update the entire installation. The software can be used to create the topology; entrance panels, guard station and indoor units are associated to the corresponding position in an easy and quick way using a scan tool. It also allows the programming of access control tools such as: RFID badges, card, fingerprint and face recognition. The software is also used to: program access control for new residents, view alarm logs, send messages to indoor units, upload advertisements and screensavers and synchronize time/date details on all devices.</p>

375003	<p>Reader for programming card and badges for building access control. Compatible with RFID badges 348200 to ..06 available in different colors. Programming and associating badges to residents requires the use of the configuration software.</p>
--------	---

375004	<p>Reader for programming fingerprints for building access control. Registering and associating the residents' fingerprints requires the use of the configuration software.</p>
--------	--

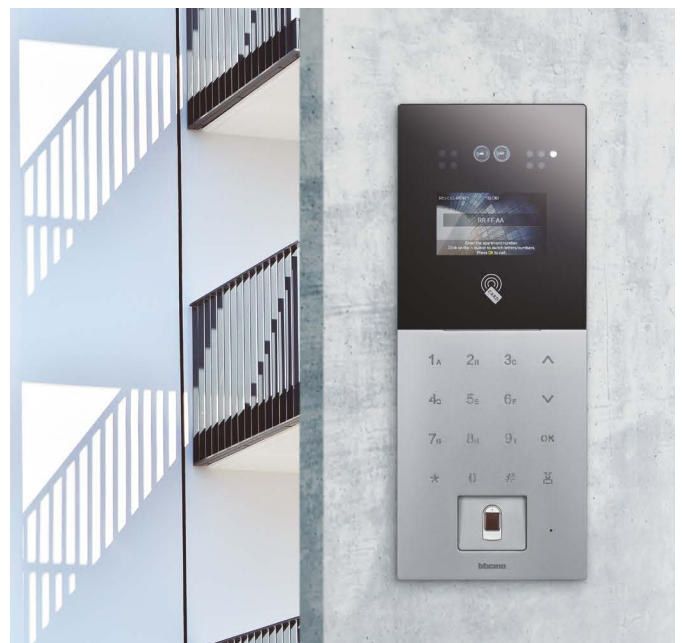

Item	Transponder badge keys	Pack
348200	● Black	10
348201	● Red	10
348202	● Green	10
348203	● Blue	10
348204	● Orange	10
348205	● Grey	10
348206	● Yellow	10

Accessories

catalogue



Item	Accessories
375002	PoE (Power over Ethernet) switch with 10 / 100 Mbps, 8 PoE ports and 1 non-POE port uplink and 24 V-100 W power supply. The PoE port is used for network communication and as power supply. DIN mounted installation (Total of 12 DIN modules).
375005	Power supply 100 W with metal box; can be operate as an auxiliary power supply. Protected against short circuits: in case of DC output short circuit, the device will switch to protected mode. Wall mounted installation.
375006	(B) Metal box for video entrance panel with 4.3" display and keypad, flush mounted installation. Compatible with Cat.No: - 374001 video entrance panel with 4.3" display and keypad, with face recognition and fingerprint - 374003 video entrance panel with 4.3" display and keypad
375007	(A) Metal box for video entrance panel with 10" touch display, flush mounted installation. Compatible with Cat.No: - 374000 video entrance panel with 10" touch display with face recognition and fingerprint - 374002 video entrance panel with 10" touch display
375008	(C) Metal box for small video entrance panel flush mounted installation. Compatible with Cat.No: 374004
375009	(D) Metal box for small video entrance panel with 4.3" vertical touch display, flush mounted installation. Compatible with Cat.No: 374005
375010	Lift control interface with protocol translator to integrate lift function in IP door entry system. The configuration is completed using a dedicate software, the interface is connected via RS 485 cable to the entrance panel and the lift.
375011	USB key to be inserted on DES Server 375001 to enable face registration and to provide access mode for face recognition in the installation. At least one of the following devices must be present in the installation: external pushbutton panel with 10" touch display with face recognition and fingerprint (374000), external pushbutton panel with keyboard, facial recognition and fingerprint (374001) or Small pushbutton panel with 4.3 "touch display (374005).
SP111	Plug-in power supply for IP server 375001. Input 100 240 Vac @ 50 60 Hz. Output 19 Vdc. Length of connection cable with IP server = 1200 mm

Item	Accessories
375012	PoE converter for BTicino IP DES devices with 24 V PoE to be installed in standard PoE + network.
375013	Lift control interface with 8 relay to integrate the IP DES with the building elevator system in order to enable the lift call after the resident answer the call and open the gate. The configuration is made directly in IP DES configuration tool included in Server DES 375001. NOTE : INSTALLATION AND CONNECTIONS MUST BE ALWAYS PERFORMED ACCORDINGLY TO THE ELEVATOR TYPE.
375014	IP Actuator in 4 DIN Module Actuator with 2 outputs to manage electromagnetic locks, timed locks, to s switch on the lights, opening gates or manage generic actuation. The configuration is done using the IP DES PRO software configuration tool. 4 DIN installation. It can be PoE (power over Ethernet) standard IEEE 802.3af, PoE 24V using item 375002.
375015	Rainshield for Small Entrance Panel 374007 Rainshield accessory for small entrance panel 374007. Surface mounting.
375016	Angular Mounting for Small Entrance Panels Accessory to mount the small entrance panels 374006 and 374007 in angular position. The support has 30° angle and can be installed on both side (on the right / left).

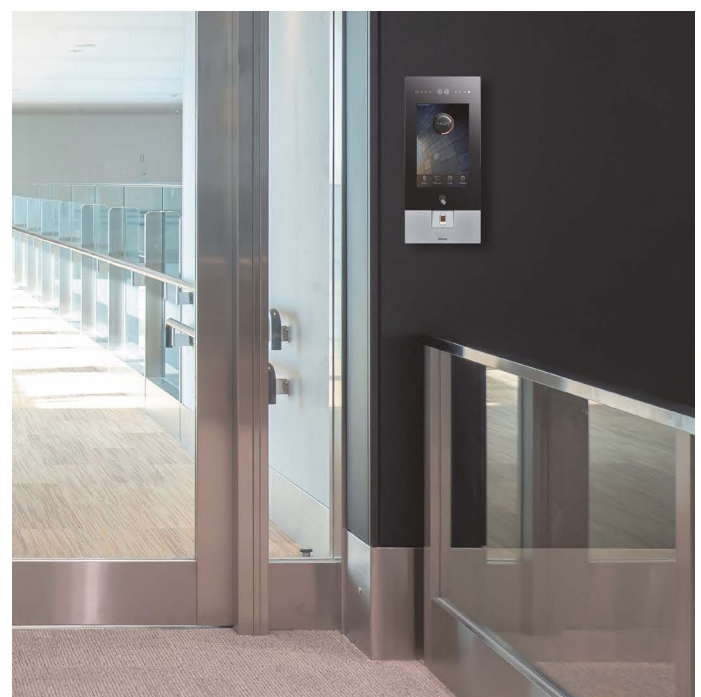

(A) - (B) - (C) - (D) - Correspondence with the related entrance panels - see entrance panels page.

Example - system architecture

- LAN Ethernet
- LAN PoE BTicino
- LAN PoE Standard

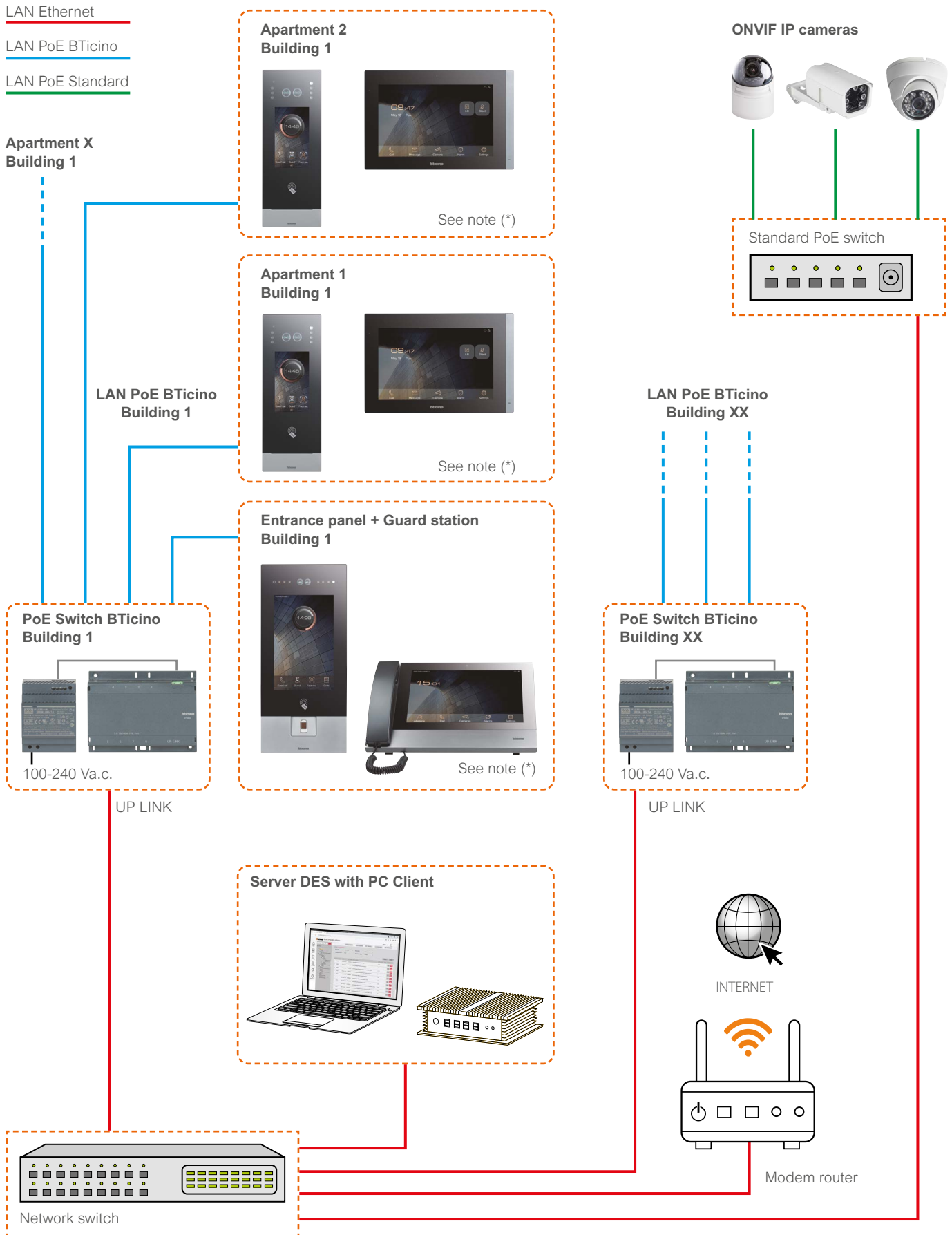

Note (*): provide a PoE LAN cable for each BTicino device.

Standard PoE compatibility

- Indoor units 373008 - 373103 - 373104 natively compatible with standard PoE (RJ45 10/100 Base T - IEEE 802.3at POE 44 V-57 V)
- For all other devices it is possible to use PoE converter accessory 375012.

LAN Ethernet

LAN PoE BTicino

LAN PoE Standard

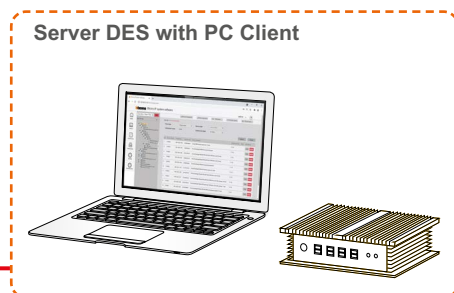
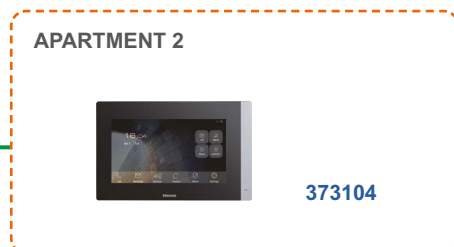
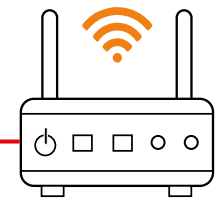
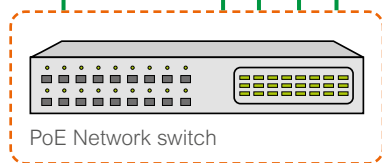
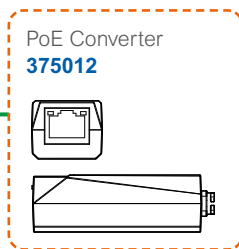
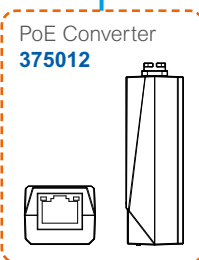

Note (*): provide a PoE LAN cable for each BTicino device.

System with standard PoE devices

- **Small entrance panel 374007** natively compatible with standard PoE (RJ45 10/100 Base T - IEEE 802.3af POE 44 V-57 V).
- **Indoor units 373008 - 373103** natively compatible with standard PoE (RJ45 10/100 Base T - IEEE 802.3at POE 44 V-57 V).
- For adding other devices it is possible to use PoE converter accessory [375012](#).

LAN Ethernet

LAN PoE Standard

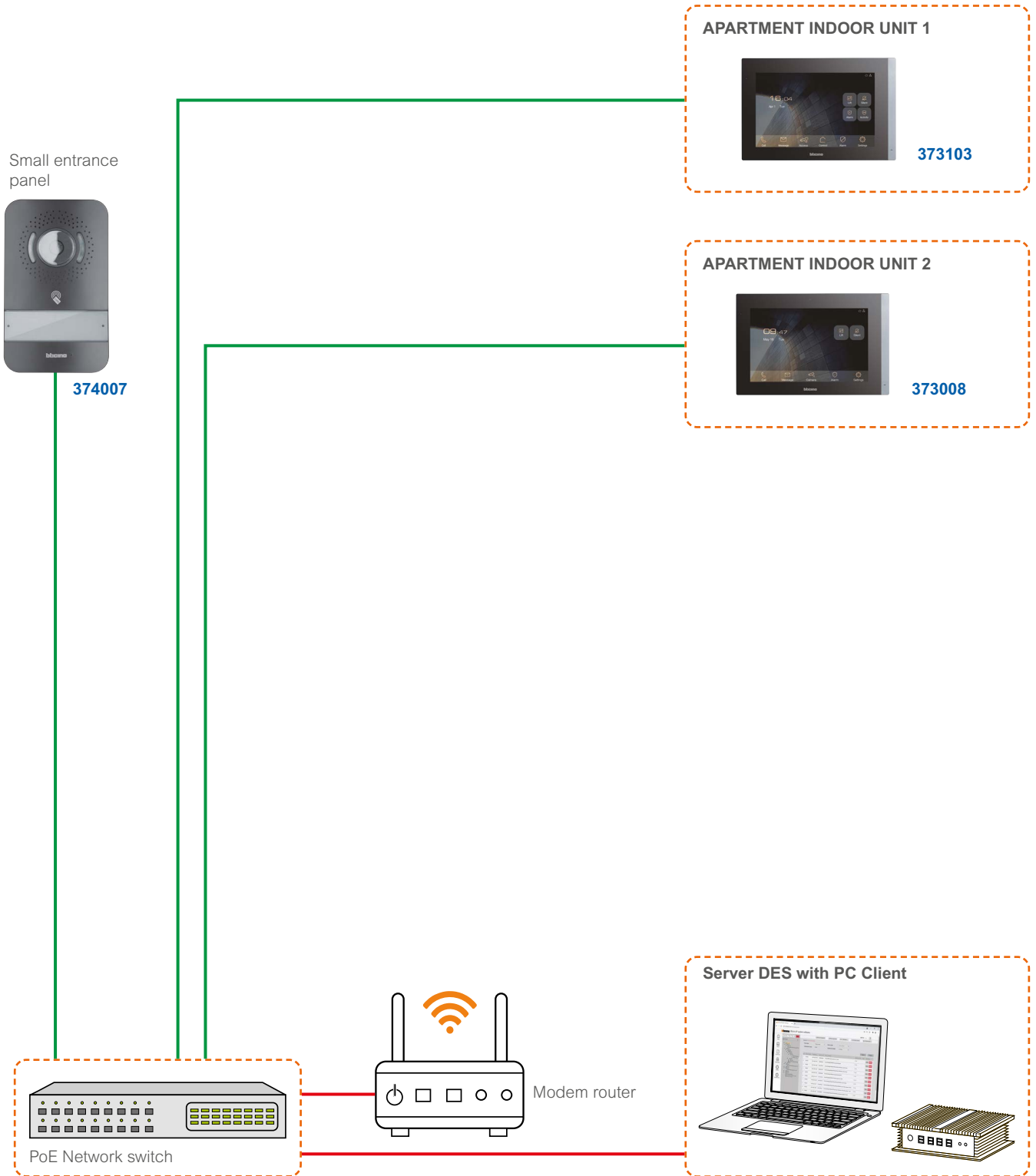

Note (*): provide a PoE LAN cable for each BTicino device.

Example - fiber optic riser connection

Fiber optic

LAN Ethernet

LAN PoE BTicino

2 x Copper cables

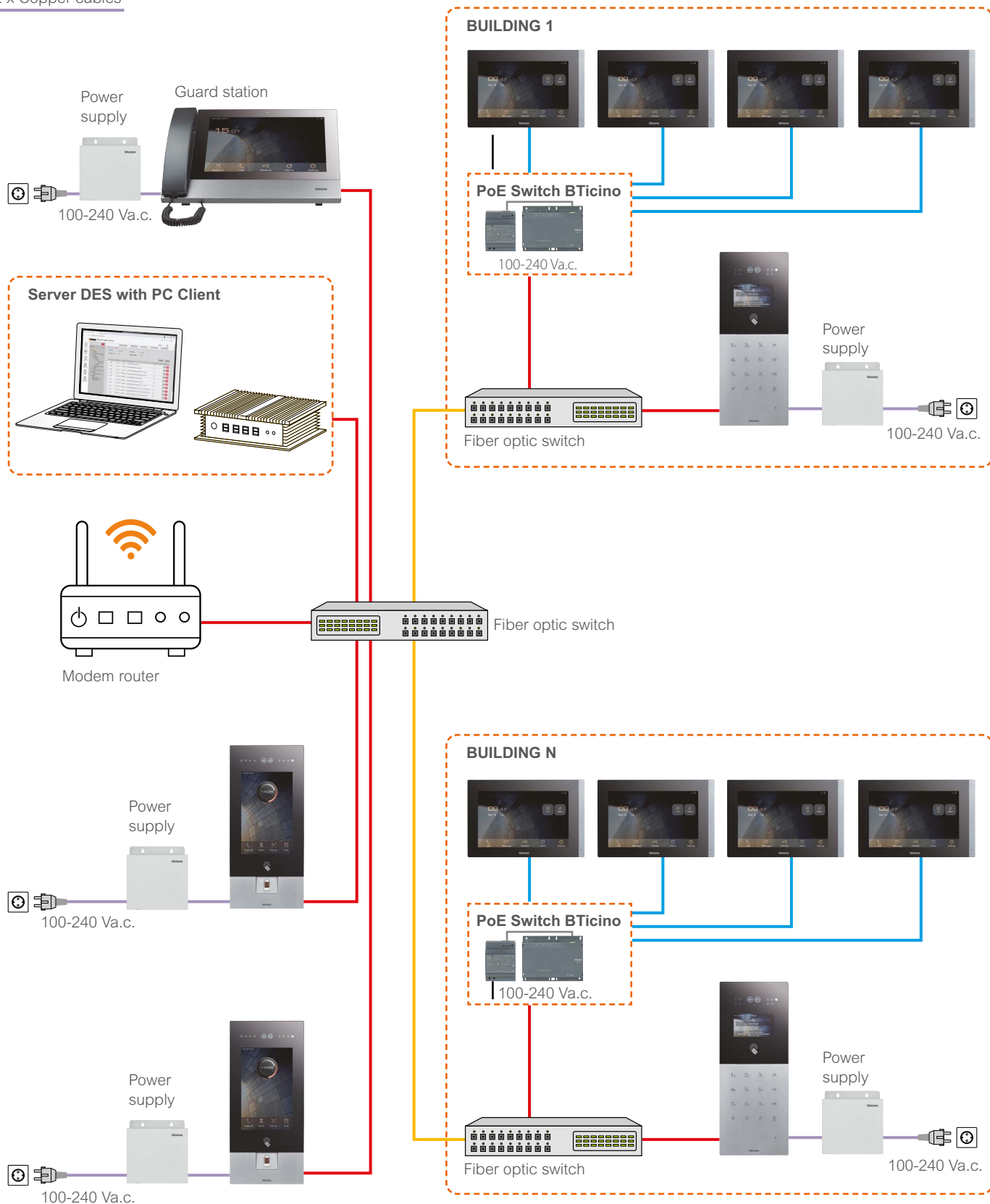

Example - alarms integration

ALARM FUNCTIONS

The guard station receives all the alarm notification messages, including the SOS alerts coming from the indoor units.

LAN Ethernet

LAN PoE BTicino

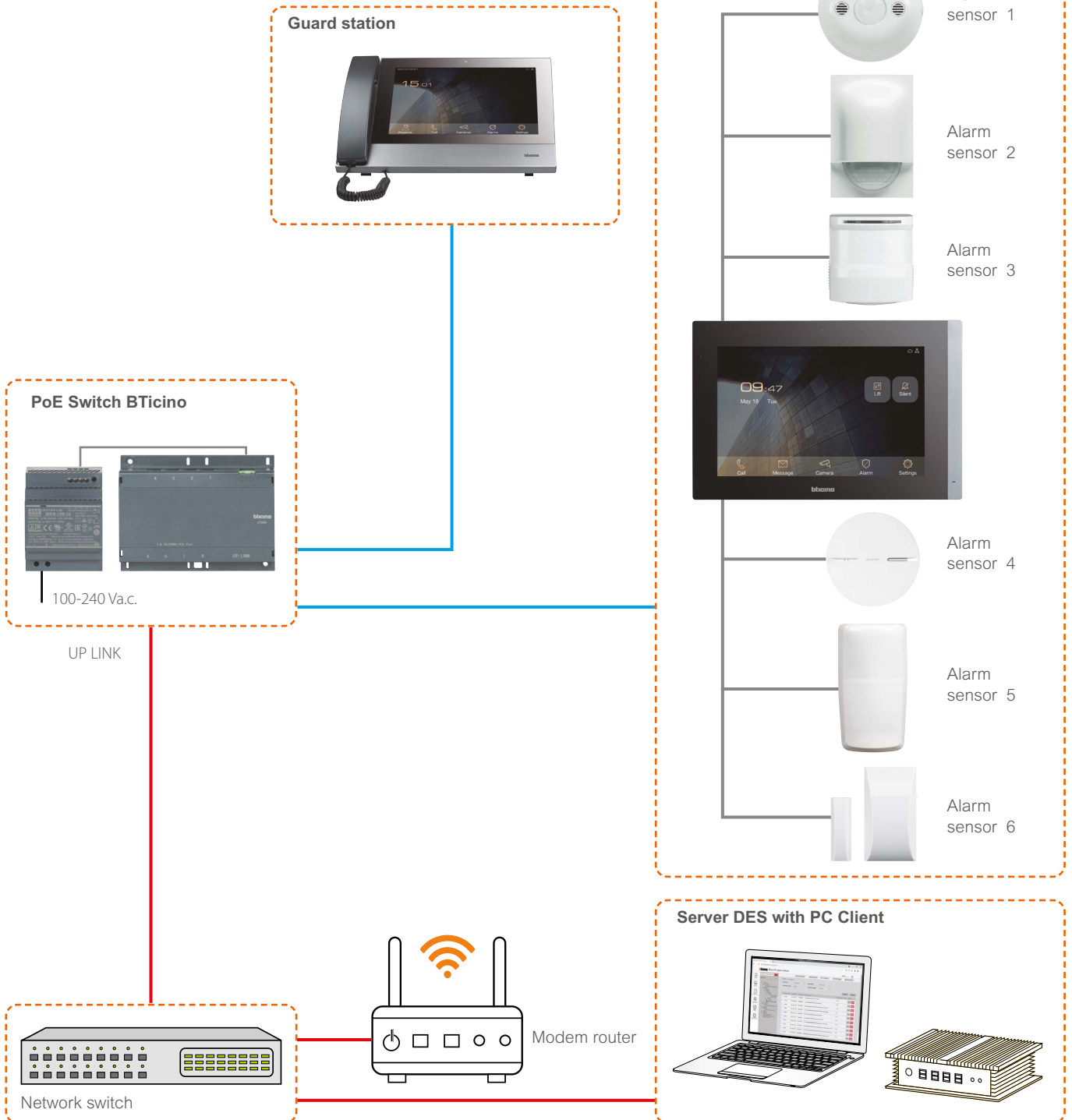

BTicino SpA
Viale Borri, 231
21100 Varese - Italy
www.bticino.com

AD-EXCM26VDEC/ENG - Edition 06/2026

Note: Certain components of the product may be subject to change over time, depending on the availability of materials, technological developments, or manufacturing requirements. These changes do not in any way affect the functionality or overall quality of the product, which will remain in accordance with the stated standards. BTicino reserves the right to update or replace individual components, always ensuring consistency with the technical specifications and the intended user experience.

bticino
A brand of  **legrand**

BTicino S.p.A. reserves at any time the right to modify the contents of this booklet and to communicate, in any form and modality, the changes brought to the same.