



Livinglight



App Home + Control

Now the system is also Smart



Livinglight ^{WITH} Netatmo

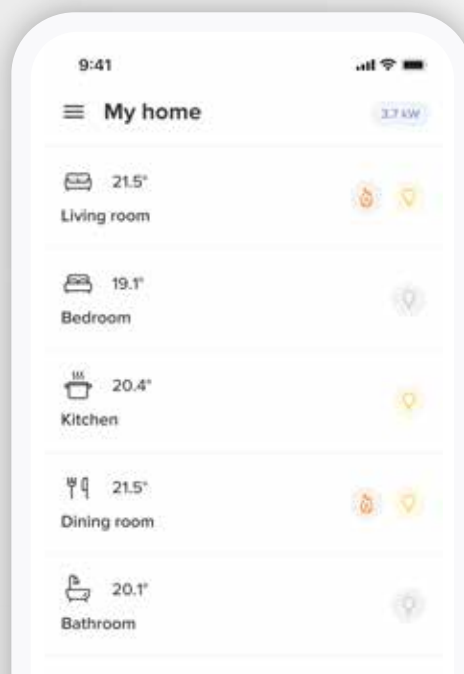

App Home + Control

Contents

<p>4-45 General features</p>	<p>LIVINGLIGHT From traditional to Smart 4</p> <p>Smart LIVINGLIGHT with NETATMO electric system 6</p> <p>Home+Control 12</p> <p>Manage the home also with the voice 14</p> <p>The ideal solution for refurbishment 16</p> <p>Turning a traditional system into a Smart system 18</p> <p>A simple range of connected wired and wireless devices 20</p> <p>New SMARTHER 2 connected thermostat 24</p> <p>LIVINGLIGHT, countless combinations 26</p> <p>LIVINGLIGHT Air 27</p> <p>LIVINGLIGHT Square Cover Plates 28</p> <p>The design of the controls 29</p> <p>New induction and USB chargers 30</p> <p>The light needed at the right time 31</p> <p>MyHOME 32</p> <p>MyHOME Voice control 34</p> <p>Hotel room solution 36</p> <p>Technology and flexibility in the office 38</p> <p>LIVINGLIGHT Installation solutions 40</p>
<p>46-124 Catalogue</p>	<p>Smart electrical system - modular version 46</p> <p>Smart electrical system - Europe version 52</p> <p>Traditional and Smart electrical system 57</p> <p>MyHOME system 89</p> <p>Installation and cover plate finishing 102</p>
<p>125-139 Technical information Dimensional data</p>	<p>Technical information 126</p> <p>Dimensional data 137</p>



LivingLight with Netatmo forms part of Eliot, the BTicino program for connected objects.



Livinglight

From traditional to Smart

AN IDEAL EVOLUTION FOR:

- Turning existing traditional systems into Smart systems with only a few wiring interventions;
- Creating new Smart systems for the control of lights, shutters and consumptions, and to prevent overload black-out;
- All this without changing your working habits.

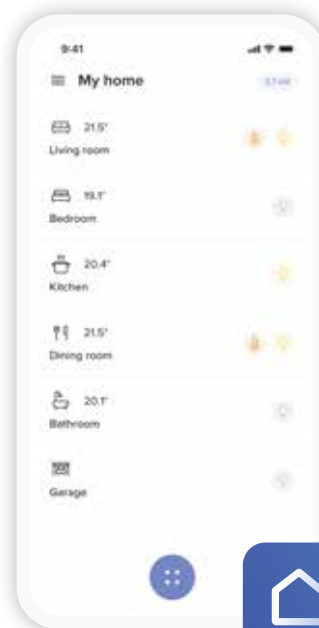

Home + Control

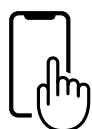

REMOTE CONTROL



CREATION OF SCENARIOS



VOICE CONTROL

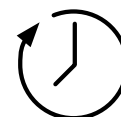

PLANNING PROGRAMMED



Livinglight

WITH
Netatmo

SMART ELECTRICAL SYSTEM

With Livinglight, you can create a connected Smart Home, freely choosing the technology depending on the needs of the customer, the complexity of the system and your installation habits.

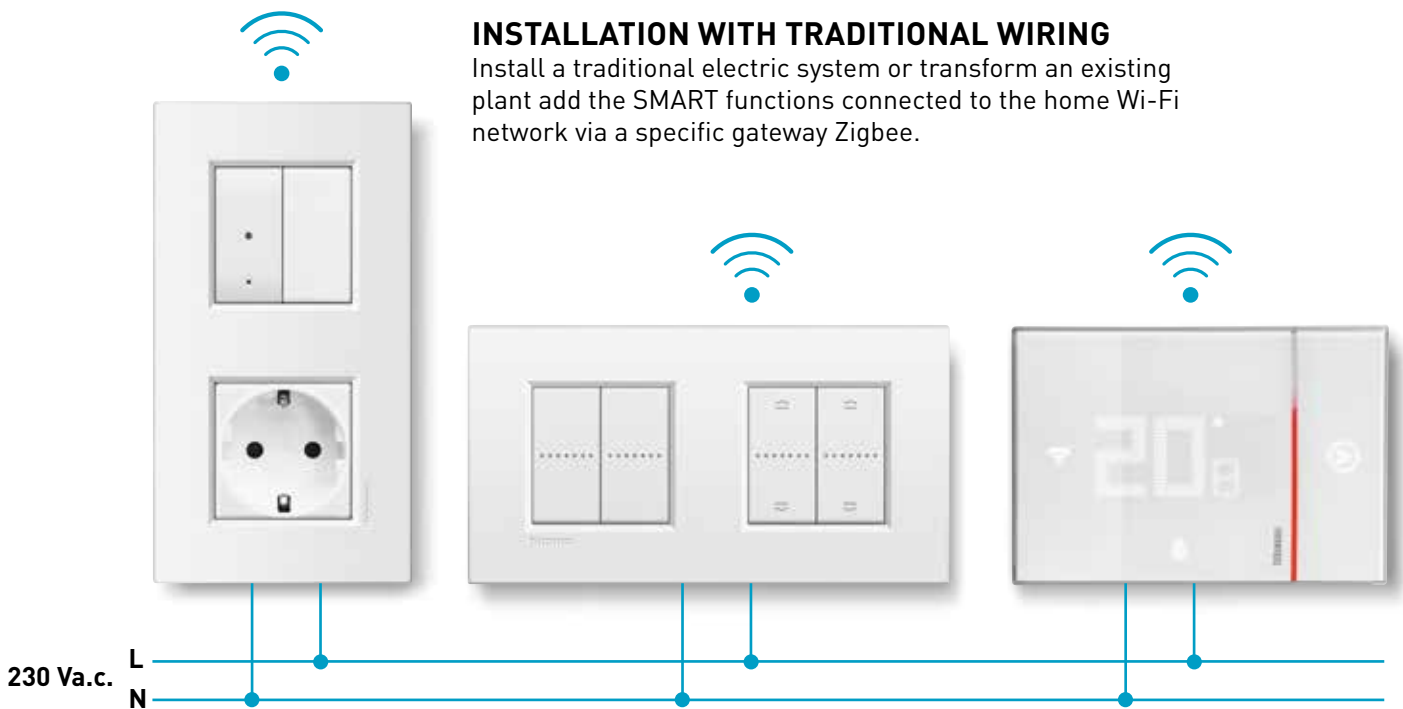

INSTALLATION WITH BUS

Does your customer have a large home and wants to build a Smart Home system with maximum integration of different systems and strong function customisation? Then choose the MyHOME home automation solution based on the BUS wiring of the devices.



SMART HOME HOME FUNCTIONS

With the Smart Home you can manage many functions of the house in a simple way.

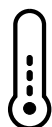

Manage the temperature according to your habits and presence at home.

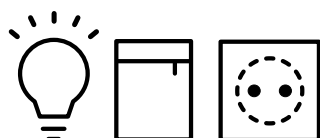

Manage lights, sockets and shutters remotely, creating convenient home/away scenarios.

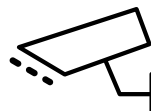

Increase home security with presence notification and alarm systems.



Manage on/off of household appliances and monitor energy consumption.

CHOOSE HOW TO CONTROL IT

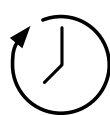
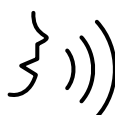
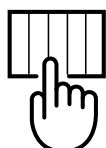

APP HOME+CONTROL: MANAGE YOUR HOME IN A SIMPLE AND INTUITIVE WAY

- Display and control the status of lights automations and loads connected to the sockets
- Adjust the temperature and create dedicated programs
- Check the home consumption
- Receive notifications about the system status
- Define the load priority for the anti-black-out prevention
- Create, customize, manage scenarios and schedules



App
HOME + CONTROL

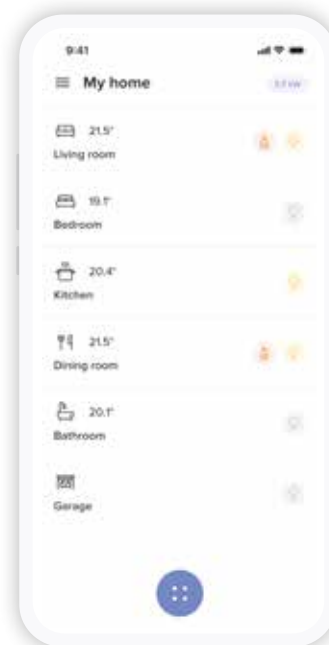

MANAGE THE FUNCTIONS ALSO WITH THE VOICE

BTicino Smart Home solutions are compatible with the Google, Amazon and Apple platforms to control the house with voice assistants.



Livinglight

WITH
Netatmo

Smart electric system

Monitoring the home is even easier.

A single Home+Control App to manage lights, shutter, energy and temperature. The function may also be easily monitored using voice controls sent through the Apple Siri, Google Home and Amazon Alexa voice assistants.



App
Home + Control



GENERAL CONTROL

With one single click, a general control will allow you to switch off all the lights and lower all the shutters when you leave your home, or to activate your favourite scenario.



CONTROL WITH SMARTPHONE

From your smartphone, you will be able to view and check the status of lights, shutters and connected power sockets from anywhere.



VOICE COMMAND

You can control your system with your voice thanks to your favourite voice assistant.

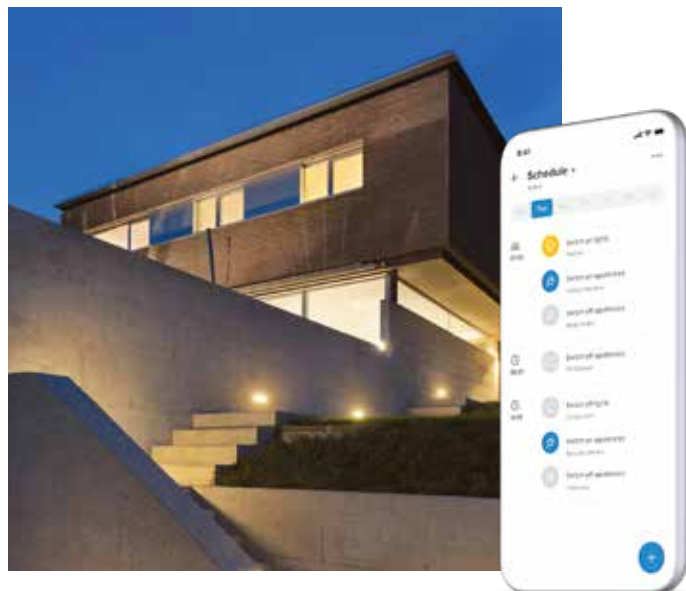

PLANNED PROGRAMMING

Program the activation of lights, shutters and loads connected to sockets based on your needs. Some examples:

- automatically switch on the garden lights at sunset and switch them off at sunrise;
- switch on some lights and activate some shutters to simulate the presence of someone in the house when on holidays.

Smart electric system

MANAGEMENT OF THE TEMPERATURE

Remotely check and manage the temperature inside your home using your smartphone and installing the connected thermostat Smarter with NETATMO.



LIGHTING AT THE DESIRED LEVEL

Adjust the light level for optimum personal comfort. You can do that from the connected Dimmer, the associated wireless controls and the Smartphone, using the Home+Control App.

LOAD CONTROL TO AVOID BLACKOUTS (*)

In overload conditions, the system automatically disconnects the least important load to avoid tripping of the meter (blackout).



ENERGY CONSUMPTION CONTROL

Use your smartphone to check the electricity consumption of your appliances (daily, monthly and yearly).



WIRELESS CONTROL

You can add wireless controls (lights, shutters and sockets), or reposition them at any time depending on your needs.



ALARM NOTIFICATIONS

You can receive warning notifications on your smartphone.

Note (*): contact BTicino for information regarding the availability of the function.

Home + Control



one single App,
many connected advantages

Home+Control is the App that makes it simple to supervise all the Livinglight Smart system functions using iOS and Android mobile devices, inside and outside the home.

The Homepage shows all the system information.



WHAT YOUR CUSTOMER CAN DO:

1. Activate and customise **8 scenarios** (4 preconfigured scenarios, coming in, going out, day, night and 4 scenarios customisable by the user);
2. **Display and check the status of lights, shutters, loads connected to sockets and the room temperature;**
3. **Use the Smarter timer thermostat** simply and intuitively;
4. **Check the total home consumptions.**
5. **Receive notifications** on the load and system status;
6. **Define the load priority** for black-out prevention*.



Note (*): contact BTicino for information regarding the availability of the function.

HOME + CONTROL CONFIGURATION IS EASY, BOTH FOR YOU AND YOUR CUSTOMER.

You simply have to download the App from the Apple or Google store, and follow the guided procedure.

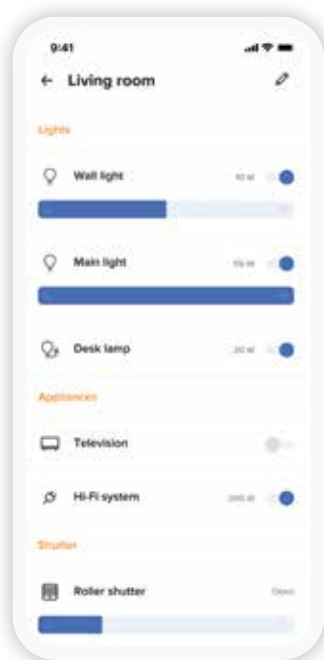

Lights, shutters
and generic loads activations



Consumption
display

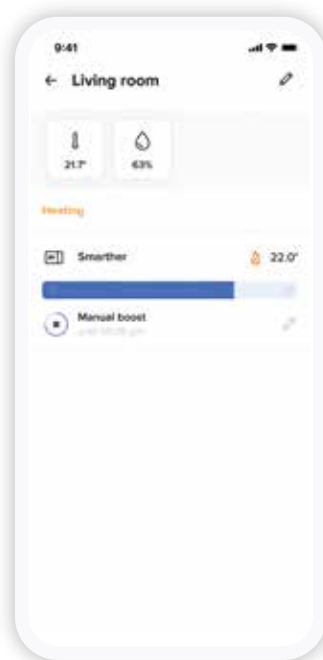

Management of the
temperature

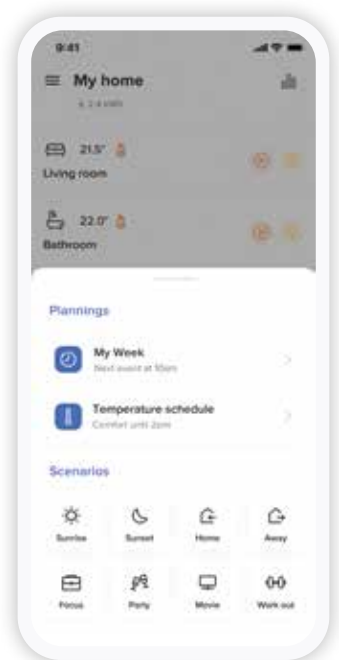

Scenario
management

Manage the home also with the voice

Use the Apple, Google and Amazon voice assistants.

Using their preferred voice assistants, your customers can control their homes hands-free: an extremely useful function also for those with mobility problems.

«Ehi Siri, close all the shutters»



Note: Home Pod, Google Home and Amazon Echo are available from Apple store, Google Store, Amazon, or from authorised retailers.

«Alexa, set the temperature to 20 degrees»



«OK Google, set the kitchen light to 100%»



HomeKit is a registered trade mark which is the property of Apple Inc. Google Home is a registered trade mark which is the property of Google LLC, Amazon Alexa is a registered trade mark which is the property of Amazon.com, Inc.



+
+
**ADDITIONAL
FUNCTIONS**



**REMOTE
CONTROL**



**CREATION OF
SCENARIOS**



**VOICE
CONTROL**



**CONSUMPTION
CONTROL**

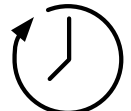

**PLANNING
PROGRAMMED**



The ideal solution for refurbishment

Your customer is refurbishing the home and has a Livinglight system?

Suggest them to upgrade to a Smart system by replacing some traditional devices with some similar connected ones. It's the ideal solution also for those who want to install a new Smart electric system without renouncing to the Livinglight design.

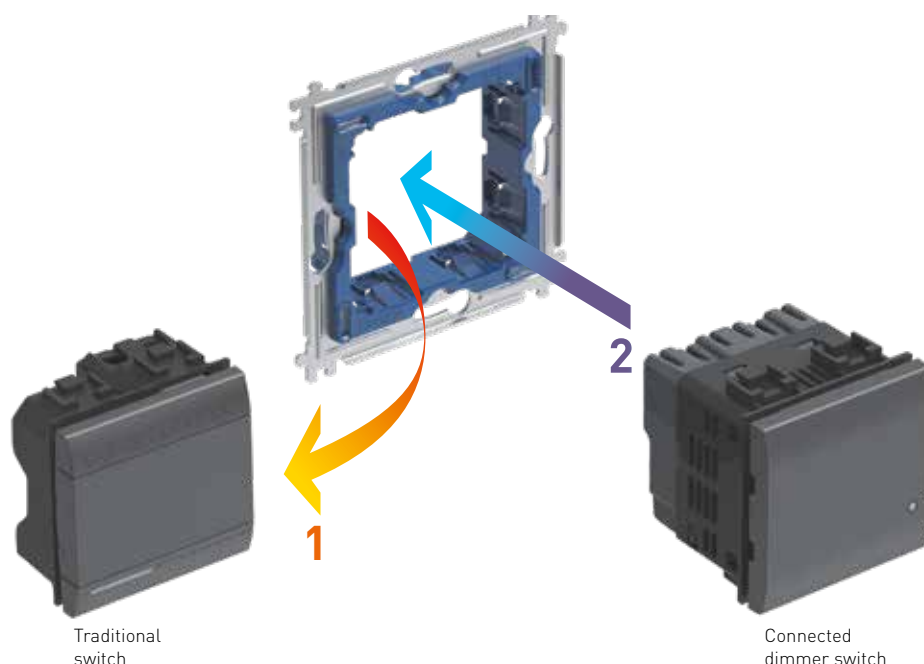

EXAMPLE OF REPLACEMENT OF A TRADITIONAL DIMMER WITH A CONNECTED ONE

Turn a traditional system into a Smart system with just a few simple steps.

1. Install the gateway in the switchboard (if item FC80GT), or flush mounted in a desired position

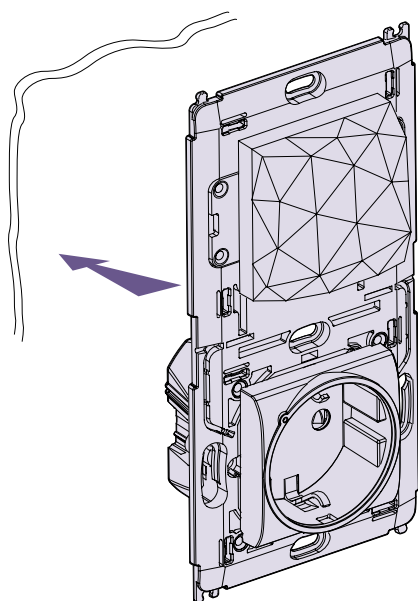

Flush mounted gateway with socket.
Ensure appropriate home Wi-Fi signal.

2. Replace current devices with the connected devices for your type of system

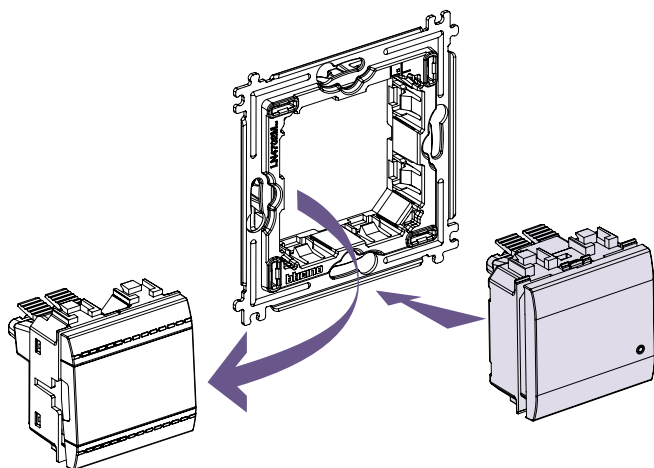

In place of a traditional device, install the connected device of the corresponding type for the managing of lights, shutters and sockets: one for each control line.

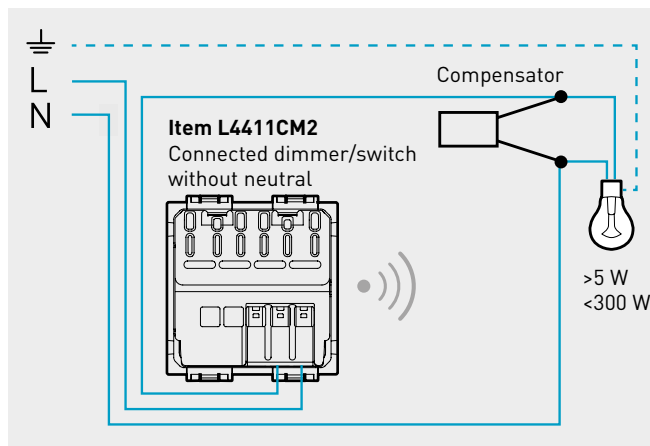

Example of connected dimmer/switch wiring

3. Add the energy meter module if desired

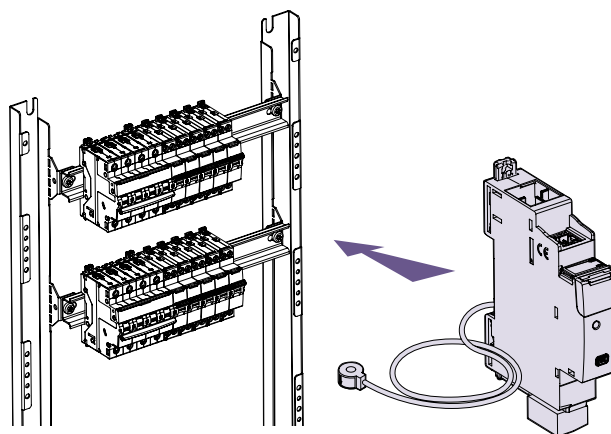

Item **F20T60**
Connected DIN meter

4. Devices can be associated to each other by simply pressing a pushbutton

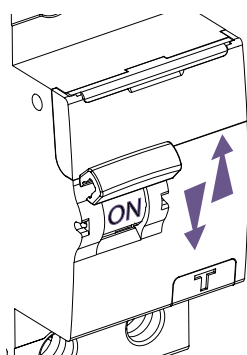

Switch the system off and on.

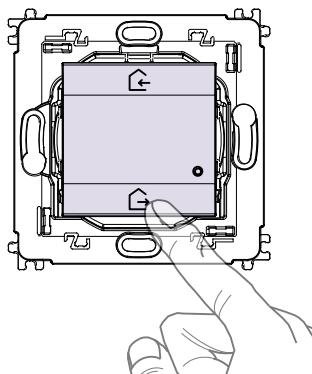

Press the Home/Away master scenario control supplied with the gateway for 5 seconds. Devices are associated to each other.

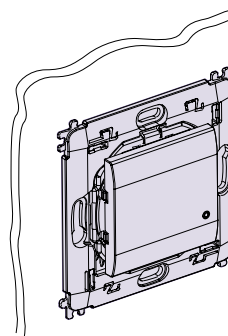

Item **L/N/NT4003CW**
Wireless wall mounted control

You can now expand the system with radio controls.

5. Download the Home+Control App from the stores and follow the guided procedure to define the objects to manage











App Home + Control

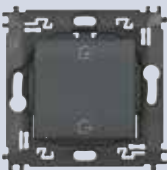

Smart electrical system

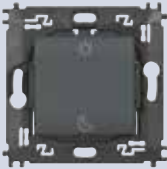
A simple, rational range of connected devices, both wired and wireless.

REMOTE CONNECTION	SCENARIOS
<p>CONNECTED DEVICES (230V A.C.)</p> <div style="display: flex; justify-content: space-around; align-items: center;"> <div style="text-align: center;">  <p>Item L/N/NT4501C Gateway with german standard socket and Home/Away wireless switch</p> </div> <div style="text-align: center;">  <p>Item L/N/NT4502C Gateway with french/belgian standard socket and Home/Away wireless switch</p> </div> <div style="text-align: center;">  <p>Item FC80GT Gateway DIN</p> </div> </div>	
<p>BATTERY WIRELESS CONTROLS</p> 	<div style="display: flex; justify-content: space-around;"> <div style="text-align: center;">  <p>Item L/N/NT4570CW Home/Away wireless switch</p> </div> <div style="text-align: center;">  <p>Item L/N/NT4575CW 4 scenarios control</p> </div> </div> <div style="display: flex; justify-content: space-around; margin-top: 20px;"> <div style="text-align: center;">  <p>Item L/N/NT4574CW Night&Day scenario control</p> </div> <div style="text-align: center;">  <p>Item 3528C Pocket remote control 4 scenarios</p> </div> </div>

LIGHTS



Item L/N/NT4411CM2
Connected
switch/dimmer



Item FC80RC
Connected
DIN relay
16 A



Item 3584C
Connected
light relay
1,3 A

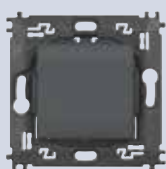

Item L/N/NT4003CW
Light control



Item 3585C
Motion sensor



Item L/N/NT4003DCW
Double light control



Item 3577C
Wireless module for
mechanical switch

SHUTTERS



Item L/N/NT4027CM2
Connected
shutter switch



Item 4027C
Connected
micromodule
for shutter



Item L/N/NT4027CW
Shutter control

ENERGY AND CONSUMPTION MANAGEMENT



Item L/N/NT4141AC
Connected german
standard socket



Item L/N/NT4142AC
Connected
french/belgian
standard socket



Item F20T60A Connected
DIN meter



Item FC80CC
Connected DIN
contactor 20 A



Item 4141PC
Mobile german standard
power outlet



Item 4142PC
Mobile french/belgian
standard power outlet

Connected
thermostat
Item XW8002
Item XW8002W
Item XM8002
Item XG8002



Note: The devices are also available in Light white and Tech gray finishes.
See catalogue for detailed descriptions, availability and full range of products.

Wireless Controls: 2 solutions to control the system in full freedom.

WALL MOUNTED INSTALLATION



IT CAN BE INSTALLED IN A FEW SECONDS

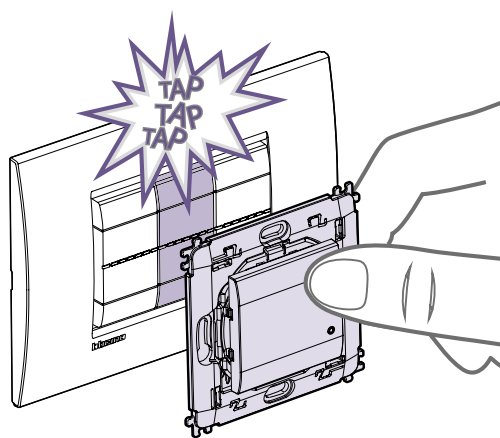

1. associate the control with a simple action

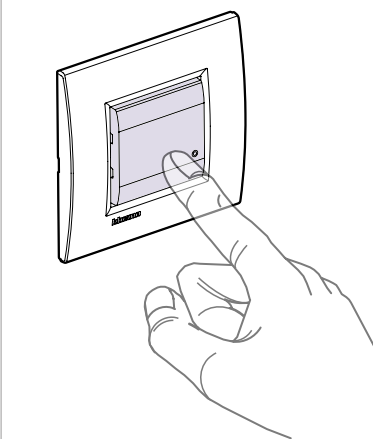
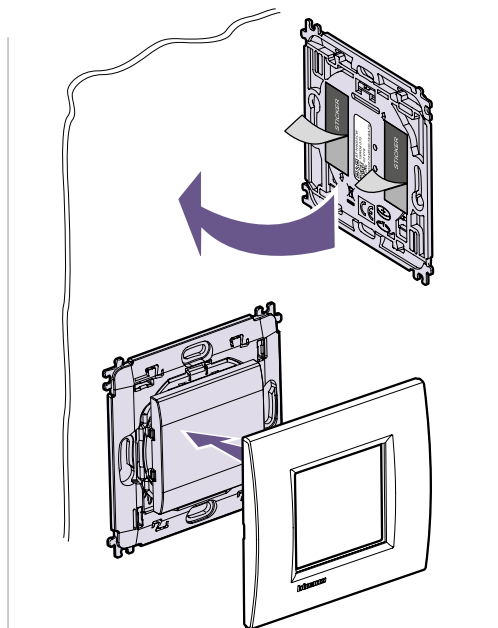

POWER SUPPLY WITH LONG-LIFE BATTERIES

The control is powered by a CR2032 battery, capable of guaranteeing operation for 8 years.

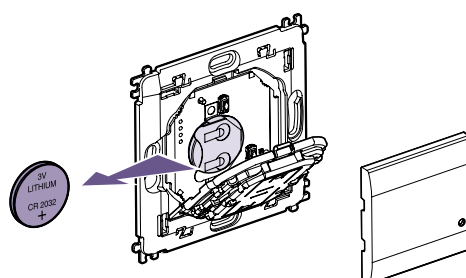

FLUSH MOUNTED INSTALLATION



Add two wireless functionalities in 2 modules, without wiring.

IT CAN BE INSTALLED IN A FEW SECONDS

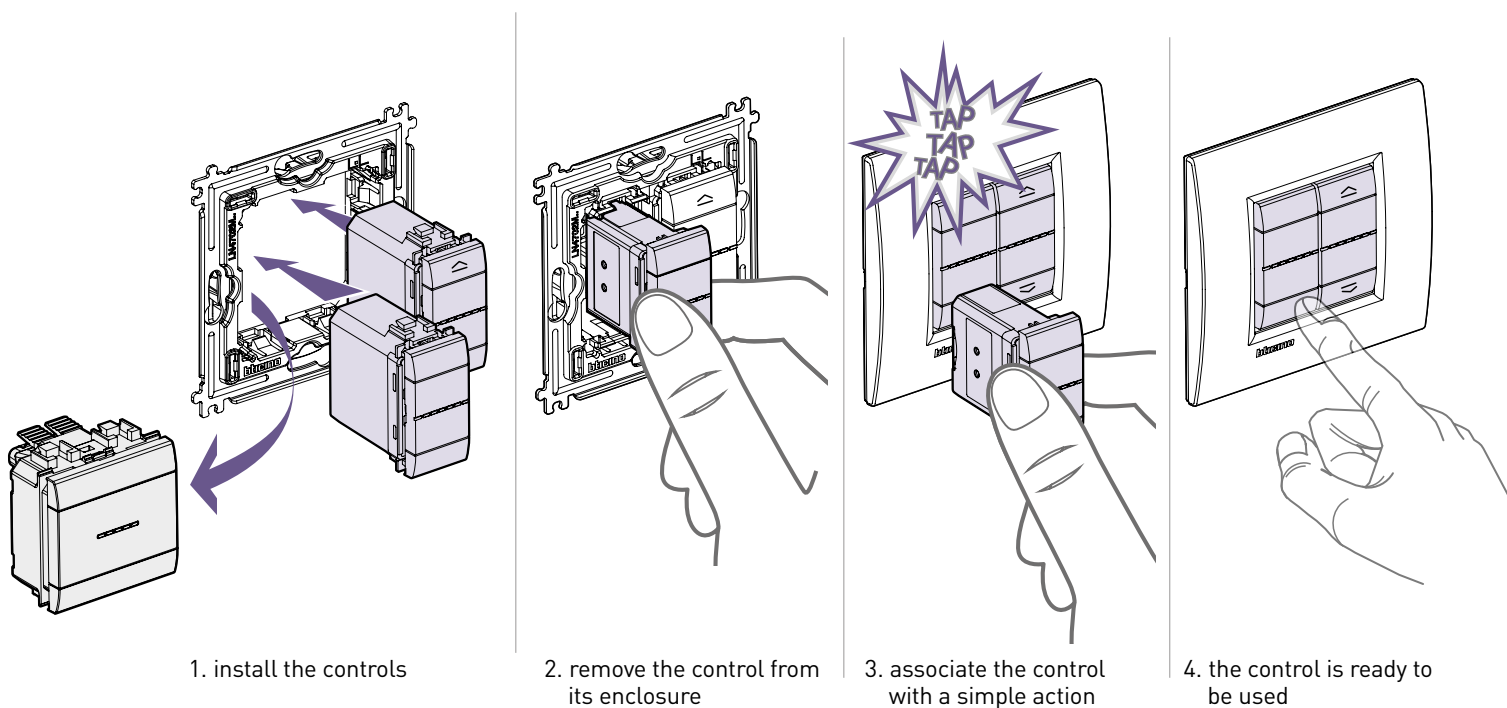

POWER SUPPLY WITH LONG-LIFE BATTERIES

The control is powered by a CR2032 battery, capable of guaranteeing operation for 8 years. The replacement does not require any tools.

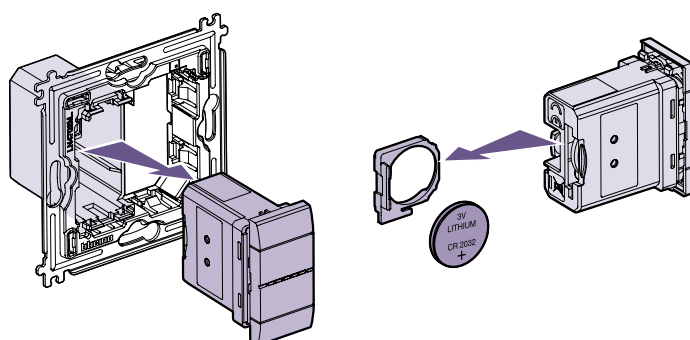



The connected thermostat

Smarter

WITH

Netatmo

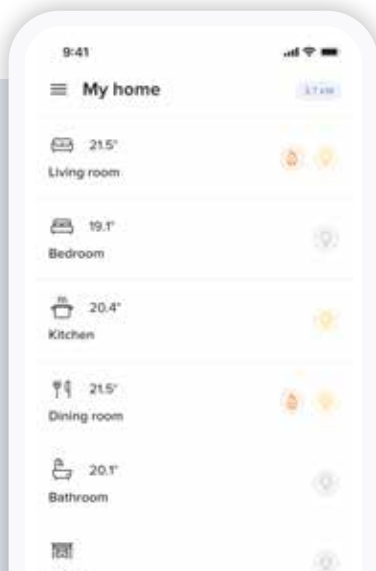

WITH THE APP IT'S ALL EASIER

- Remotely manage the thermostat simply and intuitively
- Create and modify the weekly programs
- Manage the thermostat from several smartphones and different users
- Control several thermostats in the same home or different homes
- Manage the thermostat updates
- Combine the voice command with your favorite voice assistant (Amazon Alexa, Apple Home Kit or Google Home)



What can you do with the BTicino connected thermostat?



SETTING THE PROGRAMS

Using the Home + Control App, it is possible to set preset programs based on your habits



AWAY

If you need to be away from home for a few days you can, via the APP, act remotely to adjust the thermostat (e.g. in antifrost mode) independent of the automatic programming.



BOOST

The Boost function can be used to activate the heating or cooling system for a limited time (30, 60 or 90 minutes), irrespective of the set program and the ambient temperature.



MONITORING OF CONSUMPTIONS

Using the Home + Control App, it is possible to easily manage and monitor consumptions.



MAXIMUM COMFORT IN EVERY ZONE

Using the same App, it is possible to manage several thermostats in the same home or in different homes, as well as set the desired temperature in every room for maximum comfort, thanks to the compatibility with Netatmo smart radiator valves.



The connected thermostat is simple and intuitive



Display the temperature and set it as desired



Display the set room temperature and humidity



Activate the Boost function



LOCAL DEVICE CONTROL



VOICE CONTROL



GEOLOCATION



Air



Square

A Single Range.
Three finishes of the key covers.
Two designs of cover plate.
Countless combinations.

Livinglight

COVER PLATES **Air***

Thin like no other

4.5 mm thinness.

Material: metal.

Curved lines which blend with the wall.

Livinglight satin key:

white, tech and anthracite.





KRISTALL

Square

COVER PLATES

**The classic renews itself
for a timeless design**

9.5 mm thinness

Material: metal, wood, techno polymer

Livinglight satin key: white, tech and anthracite



NEUTRAL



NATURALIA



METALS



WOODS



DEEP



SILK

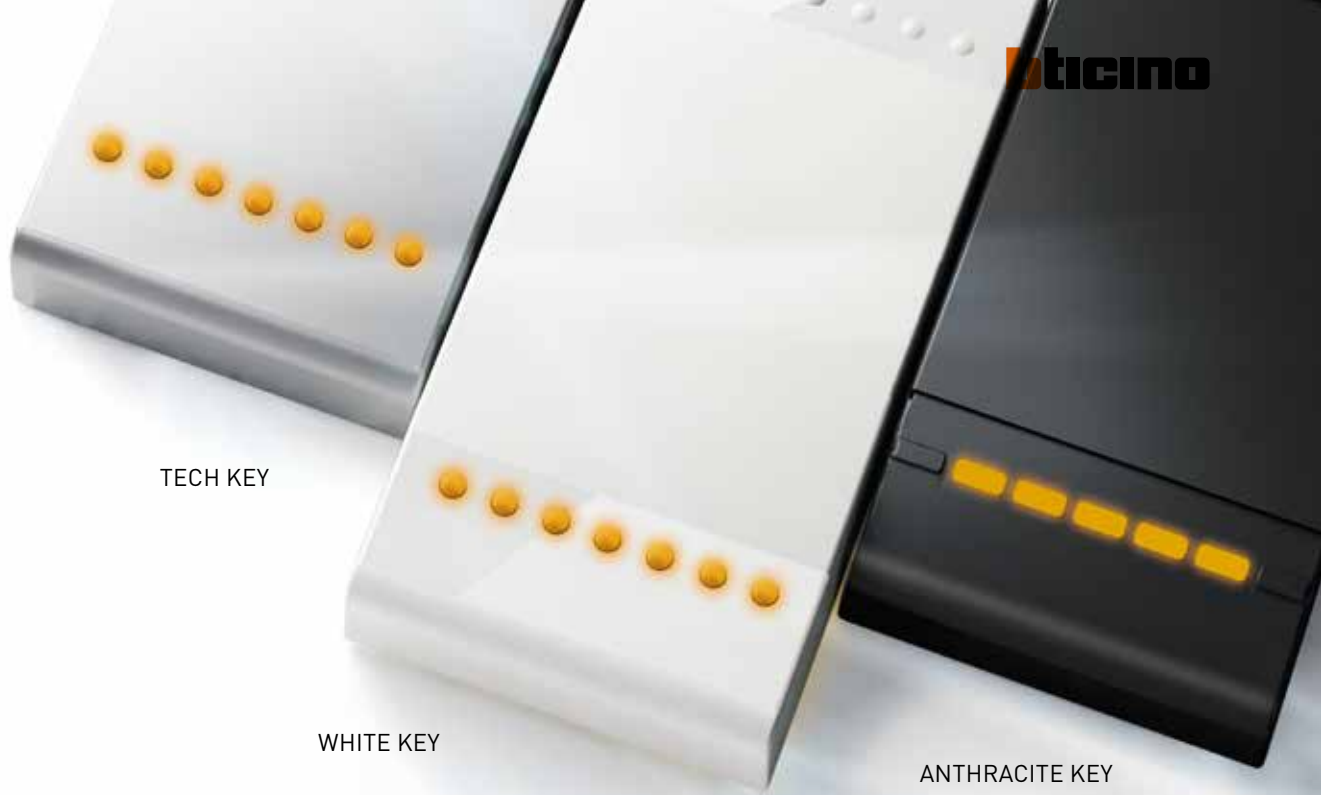

TECH KEY

WHITE KEY

ANTHRACITE KEY

The design of the controls

FEATURES

- Satin finish.
- LED backlight.
- Ergonomic and noise reduction.
- Axial controls with REDUCED depth.
- Axial Smart controls.



AXIAL SMART CONTROLS

All controls in the LivingLight with Netatmo range are available only in the axial variant and blue LED lighting.

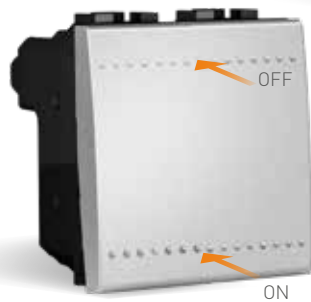

ROCKER CONTROLS



AXIAL CONTROLS

The axial controls are ideal for best taking advantage of the planarity of the new AIR cover plate.

New Type-C USB chargers

Faster charging and maximum flexibility for all uses.

HIGHER RECHARGING SPEED

Do you need to recharge several phones, or do you wish to reduce charging times? Up to 30 W in the 2-module versions.

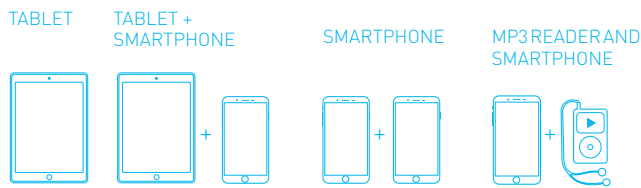

LOOKING AT THE FUTURE

Also available with the new C Type connection compatible with fast charging standards Quick Charge 3.0 and Power Delivery that is becoming more and more in use with the new tablets and smartphones.

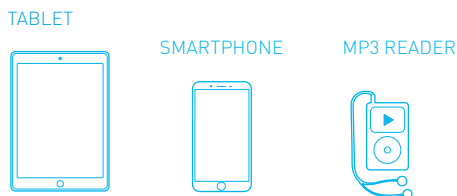
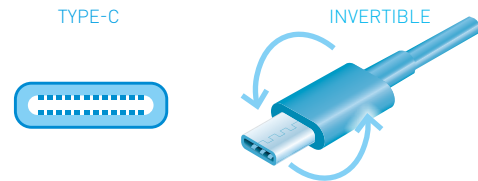

FLEXIBILITY OF USE

From the private home to the office, from the hotel to common areas BTicino USB chargers satisfy modern charging needs for every device.

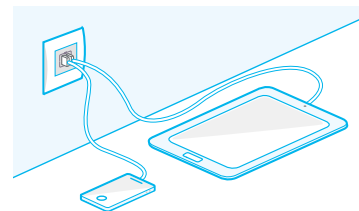

SUITABLE

For all rooms thanks to their small size. Recommended in the bedroom or kitchen. For the quick charge of smartphones and tablets. Allows you to free up sockets.



Single output Type C 30 W



Double output type A+C and single output type C 15 W

The light needed at the right time

The LED lighting devices contribute to the comfort and security of the home, helping to create comfortable surroundings.



SWIVEL 360° LAMP

Can be turned by 360 degrees. Particularly suitable for lighting work surfaces (e.g. hob, writing desk, etc.). Like a normal lamp, it can be controlled using standard controls.



DIRECTIONAL LAMP

Ideal for places where people walk such as staircases and corridors. It guarantees correct lighting at night



DIMMER READING LAMP

Flexible stem. Possibility to direct the lamp light beam. Adjustment of the LED brightness.



1 MODULE SAFETY LAMP

Minimum space. Activation: in case of black-out It guarantees ample lighting for 2 hours.



NEW REMOVABLE TORCH

Push&pull extraction system. High light intensity. Activation in case of black-out.

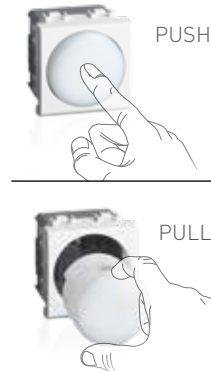

MyHOME

Install a BUS SCS home automation system, configure it with the HOME+PROJECT app and manage it with the HOME+CONTROL app.



Voice control



Control

BUS

BUS SCS SYSTEM

MyHOME is the high technology BTicino home automation system for the more advanced electric systems in terms of comfort, safety, energy savings, audio/video communication and local or remote control.

The heart of the system can be the server MYHOMESERVER1 or the new Classe 300EOS with Netatmo, a connected video door entry that also act as a server for the integration of all the system functions that can be managed through the specific HOME + CONTROL App.

APP HOME + CONTROL

Through HOME + CONTROL it is possible to:

- Display and control the status of lights automations and loads connected to the sockets;
- Adjust the temperature and create dedicated programs;
- Check the home consumption;
- Receive notifications about the system status;
- Define the load priority for the anti-black-out prevention;
- Create, customize, manage scenarios, schedules and automations.

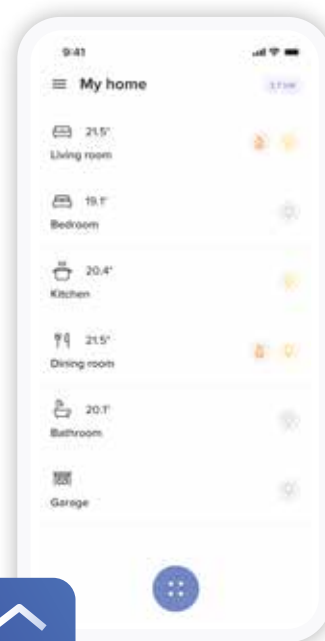

App HOME + CONTROL

EVERYTHING UNDER CONTROL

Thanks to MyHOME, end users can manage their homes in full freedom: using manual controls, Touch Screen devices, the home automation menu of the Classe 300EOS with Netatmo internal unit, Smartphones with the HOME + CONTROL App and through the Voice Control Alexa built-in and also with the Amazon and Google vocal assistants.

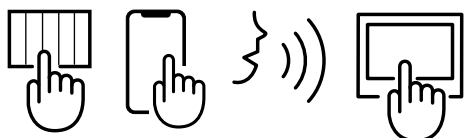

Display thermostat

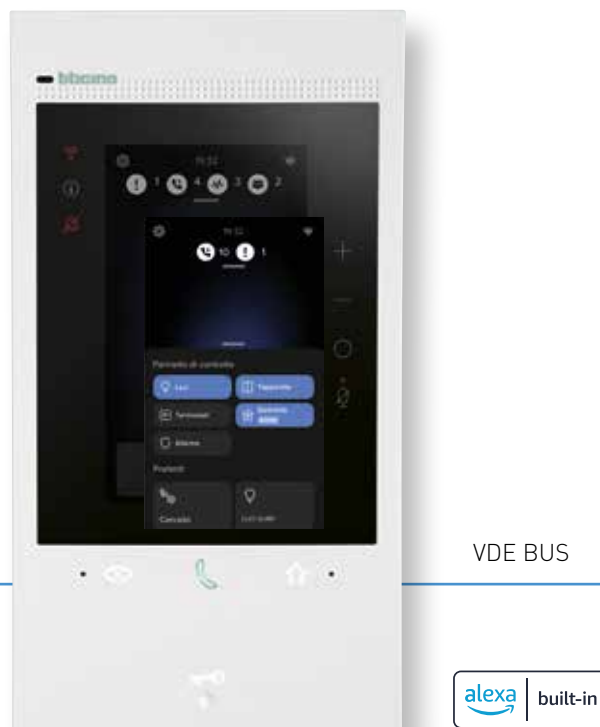

Classe 300EOS with Netatmo (*)

Third-party products and devices

Indoor and outdoor Netatmo cameras

APP HOME + PROJECT

The installer App for easy system configuration and design, available in two versions:

- Web App, dedicated for the design phase of the installation and available at <https://homeproject.legrand.com>;
- Mobile App, for on-site system configuration using your iOS and Android Smartphone.

Simple configuration, in just 3 steps:

1. Design the system at the office or directly on site: create the project with the list of rooms and objects. Archive the created projects and use the copy/paste function to replicate the structure of one in installation over other projects.
2. Configure the system on site: connect to the system through the Wi-Fi network generated by the web server and associate commands with actuators to define their functions.
3. Hand the system over to your Customer: all your Customers will manage the functions with the HOME + CONTROL App.



App HOME + PROJECT

NOTE (*) Install Classe 300EOS with Netatmo as Gateway in case of new installations in which the video door entry system is planned. In case of new installations without the video door entry function or when this function is provided but not with Classe 300EOS with Netatmo, the standard MyHOMEserver1 must be used.

VOICE CONTROLS

Control the MyHOME functions with your voice

■ With BTicino devices

CLASSE 300E0S WITH NETATMO: THE FIRST VIDEO INTERNAL UNIT WITH BUILT-IN ALEXA

Enjoy the full Alexa experience interacting with all its functions, such as: Custom routines - Smart Home - To set the clock alarms - Memos and video door entry functions. Also compatible with HOMEKIT.



VOICE CONTROL WITH BUILT-IN AMAZON ALEXA VOICE ASSISTANT

Innovative device without cover plate with built-in Amazon Alexa voice assistant for flush mounted installation. Ideal for installing in each room of the home a voice control for the management of MyHOME.



■ Or with Google and Amazon voice assistants

Thanks to the integration of MyHOME with the Google Home and Amazon Alexa voice assistants you can now control the lights and controlled sockets and, using the scenarios, the shutters, burglar alarm, ideal temperature and the music played by the system using your voice as well.

An important functionality which improves the comfort and usability MyHOME, especially by old people or long-stay patients who cannot interact with the manual controls.

As well as asking for information on the news, weather, times etc. you will be able to interact with the MyHOME system by using voice controls of the following type:

- "Ok Google, switch off all the lights"
- "Alexa, raise the living room shutters"
- "Alexa, welcome me home".



"Alexa, welcome me home"

"Alexa, what will the weather be like tomorrow?"



**YOU ASK,
ALEXA ANSWERS.**

Use your voice to activate the home automation functions of your home: lights, shutters, scenarios, or ask for any other information.

Note: with the "Welcome me home" scenario, it is possible to activate lights and shutters and disable the burglar alarm.

"Alexa, set the alarm for 7:30"

"Alexa, switch off the lights"

"Alexa, activate the relaxation scenario"



Note: with the "Relax" scenario, it is possible to activate lights and shutters, set a comfort temperature and listen to the preferred music through integrated third-party sound systems.



MANAGEMENT OF THE ROOMS AND THE COMMON AREAS

Using the management software it is possible to supervise and control in real time the status of the rooms, and interact with them.



Solutions for Hotel

The MyHOME technology offers specific solutions capable of meeting the needs of customers as far as: available services, comfort, simplicity of interaction with products and functions. A complete offer for a state of the art electric system also inside the hotel room.

PREMIUM OFFER



OUTSIDE THE DOOR INDICATOR + KEY CARD READER
DND (do not disturb)
MUR (make up the room)



LED LAMP
with "do not disturb - make up room" notification diffuser; bell and badge reader



"DO NOT DISTURB - MAKE UP ROOM" notification pushbutton



BADGE HOLDER for room power connection (power on)

THE CORRECT ATMOSPHERE, WITH JUST ONE MOVEMENT



DIMMER READING LAMP



DIGITAL THERMOSTAT MYHOME



MYHOME 8-KEY CONTROL (CUSTOMISABLE)

CONNECTION, ENTERTAINMENT AND MULTIMEDIA FEATURES



HDMI AND USB CONNECTORS for electronic devices such as dvd players, digital cameras and mp3 readers

THE FUNCTION IS IMMEDIATELY RECOGNISABLE



PUSHBUTTONS for blind opening regulation, bed head and bedside cabinet light level adjustment

DIGITAL CONTROL OF THE TEMPERATURE

PREMIUM OFFER



DIGITAL TEMPERATURE PROBE with display and touch controls

Technology and flexibility in the office



All the network at hand's reach:
from electric distribution to
data and audio/video signal
management structured
cabling systems.

MAXIMUM INTEGRATION

LIVINGLIGHT can be installed in all the Interlink
solutions: columns, work stations, protruding towers
and pop-up underfloor boxes.

SINGLE-FACE
COLUMN



MEETING ALL CONNECTION REQUIREMENTS

Full aesthetic coordination of LIVINGLIGHT with the different systems.

- BTNET, structured cabling system,
- Audio/video signals and data distribution.



AUDIO AND VIDEO CONNECTORS



NEW RJ45 TOOLLESS CONNECTORS

POP-UP UNDERFLOOR BOXES

ALUMINIUM

WHITE

BLACK

STEEL

BRASS



UNDERFLOOR BOX



PROTRUDING TOWER



WORKSTATION

FLUSH-MOUNTED IN MASONRY WALLS

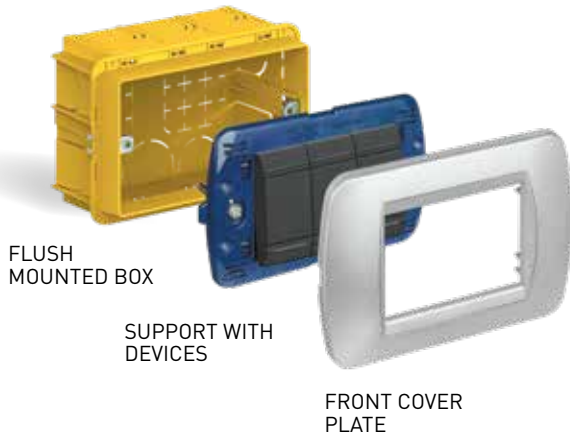

FLUSH-MOUNTED IN PLASTERBOARD WALLS

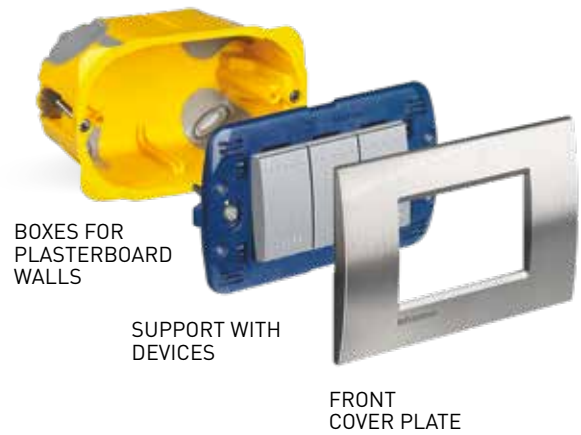

Livinglight installation solutions

WALL MOUNTED

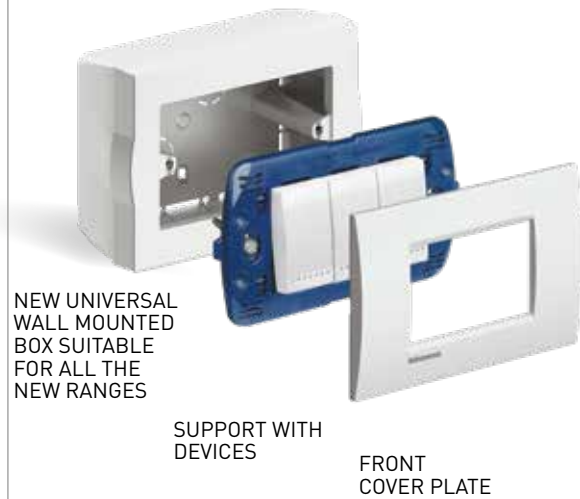

IN IP40 - IP44 - IP55 PROTECTION HOUSINGS

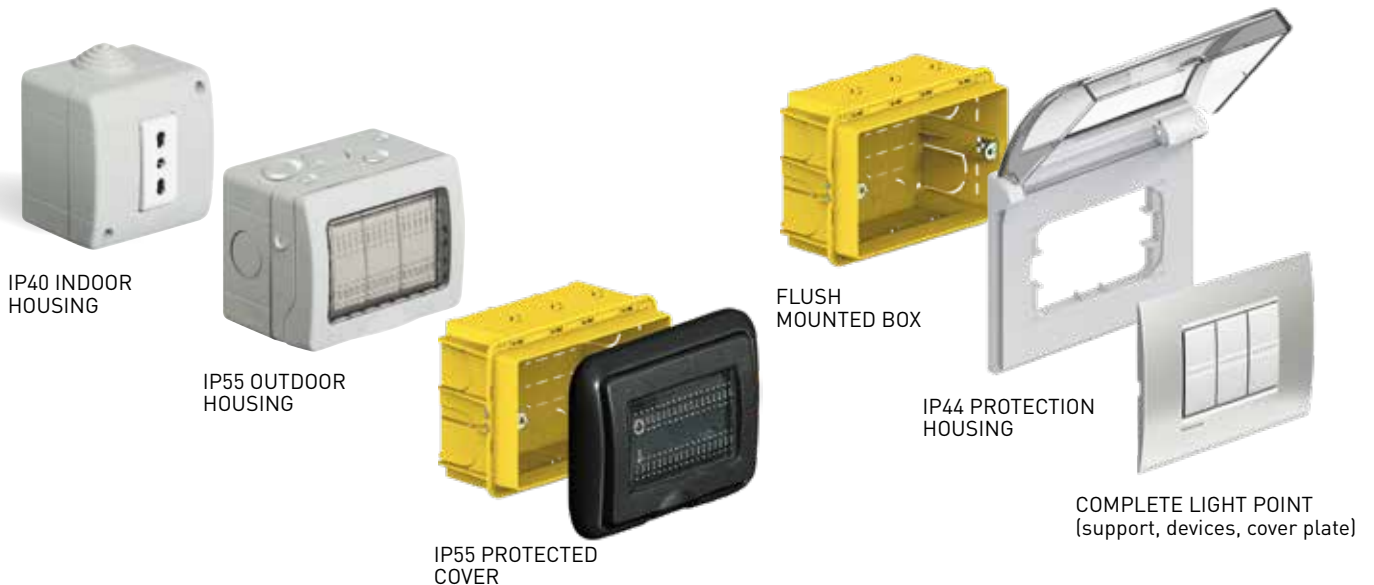

ON RAILS



BOX

SUPPORT WITH DEVICES

FRONT COVER PLATE



BOX

SUPPORT WITH DEVICES

FRONT COVER PLATE

OTHER INSTALLATION SOLUTIONS



WORKSTATION TRUNKING



PROTRUDING DOUBLE-FACE FLOOR TOWER



INTERLINK WALL MOUNTED CONTROL UNIT



EQUIPPED INTERLINK TRUNKING



TABLE-TOP DEVICE HOLDERS



SINGLE-FACE AND DOUBLE-FACE COLUMNS

SQUARE INSTALLATION: 2 MODULE AREA SYSTEM

Standard flush mounted boxes

Livinglight

can be installed using normal flush mounted boxes and 2 module supports.

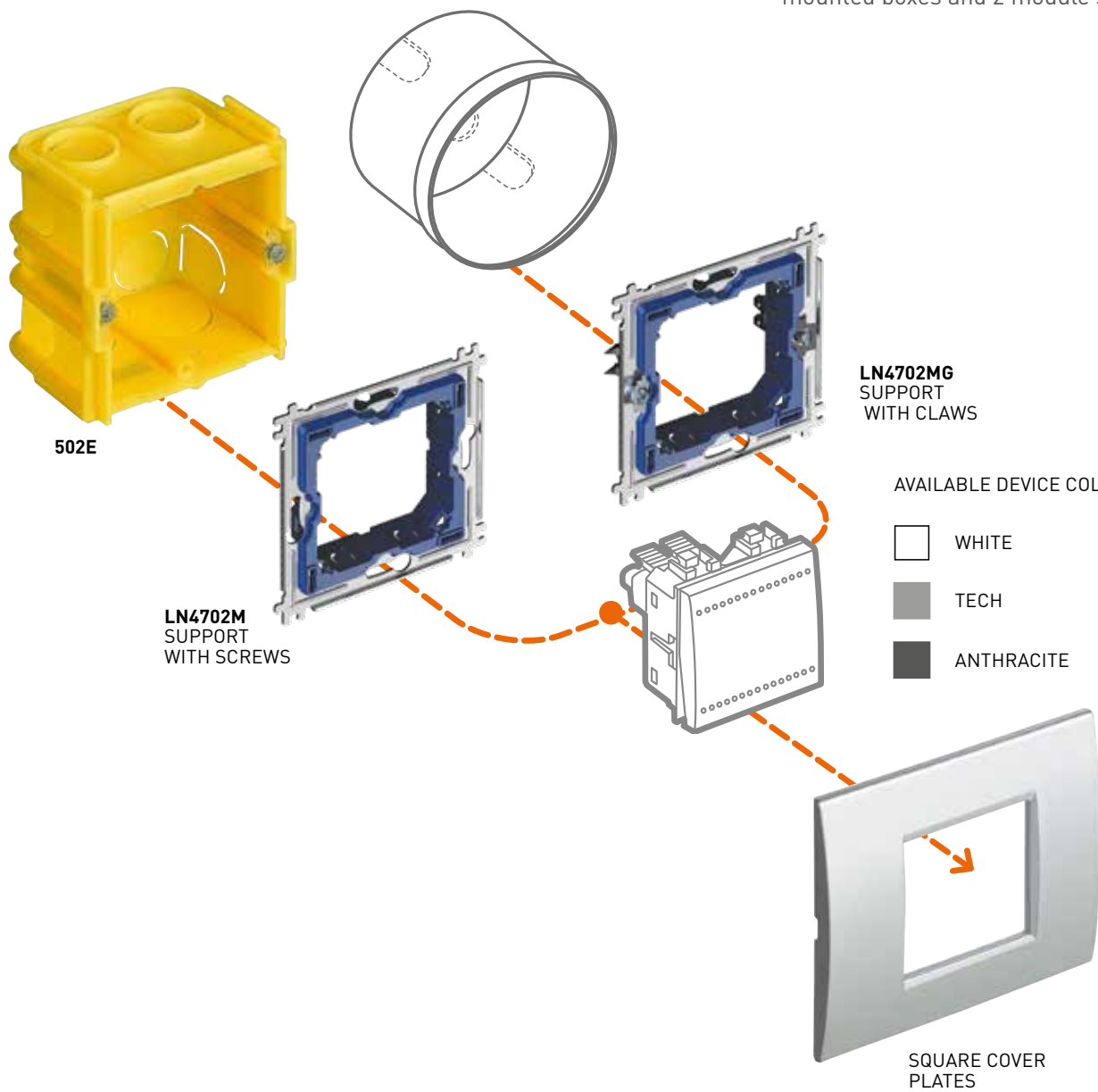

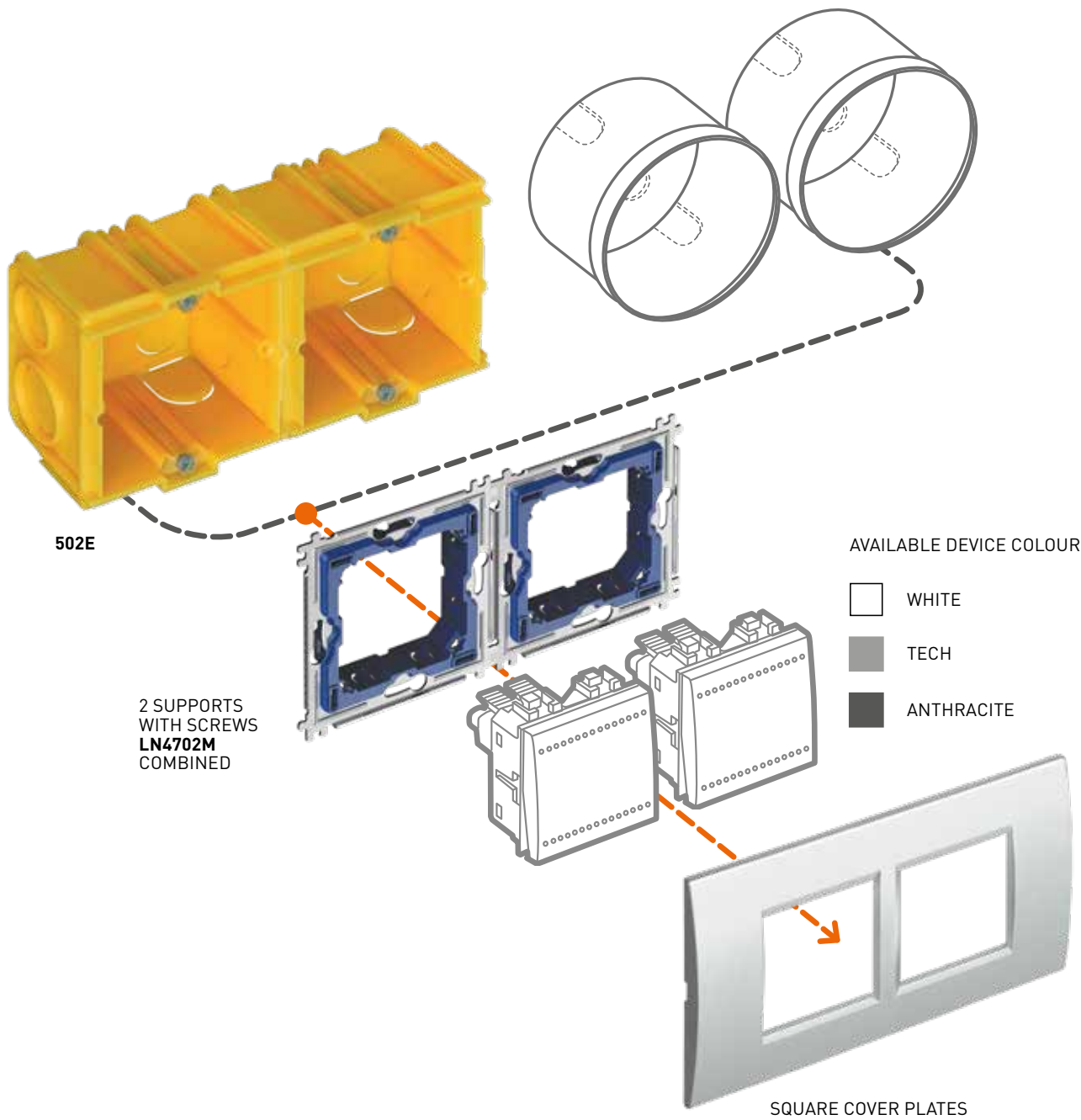

AIR INSTALLATION: 2 MODULE AREA SYSTEM

502E
BOX WITH SCREWS
FOR MASONRY
WALLS



PB502N
PLASTERBOARD
BOX



LN4702E
SPECIFIC SUPPORT FOR AIR
2 MODULE AREA INSTALLATION



AVAILABLE DEVICE COLOURS

- WHITE
- TECH
- ANTHRACITE

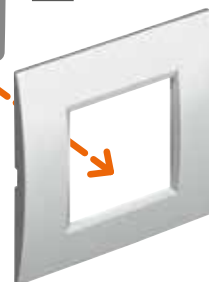
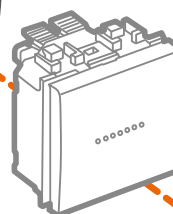

2 x **PB502**
PLASTERBOARD
BOXES

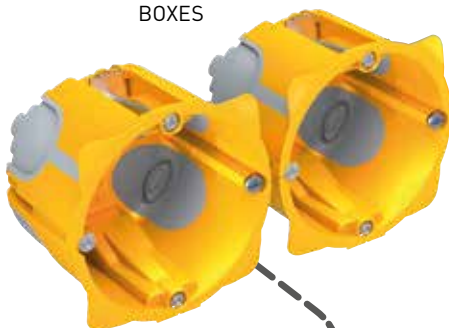

2 x **502E**
DIRECTLY COUPLED TO
EACH OTHER

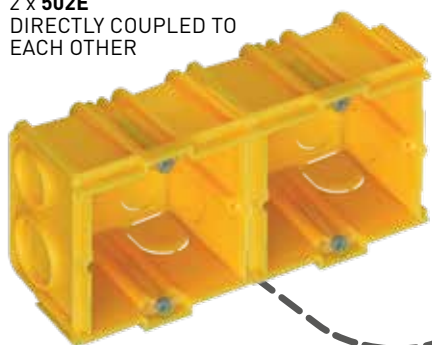

LNE4802...
AIR COVER PLATE
FOR 2 MODULE AREA
INSTALLATION

2 x **LN4702E**
DIRECTLY COUPLED TO
EACH OTHER

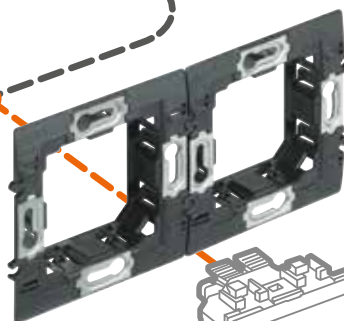

AVAILABLE
DEVICE COLOURS

- WHITE
- TECH
- ANTHRACITE

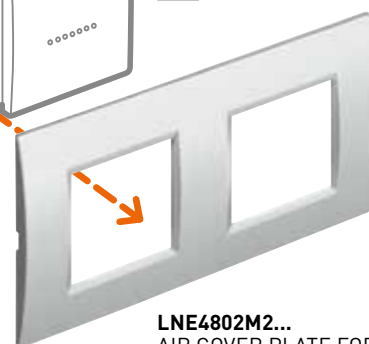
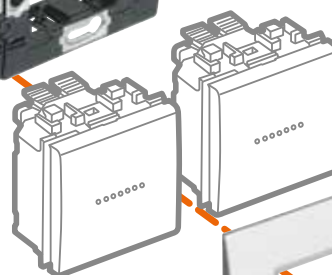

NOTE: HORIZONTAL OR
VERTICAL INSTALLATION

LNE4802M2...
AIR COVER PLATE FOR
2 MODULE AREA INSTALLATION

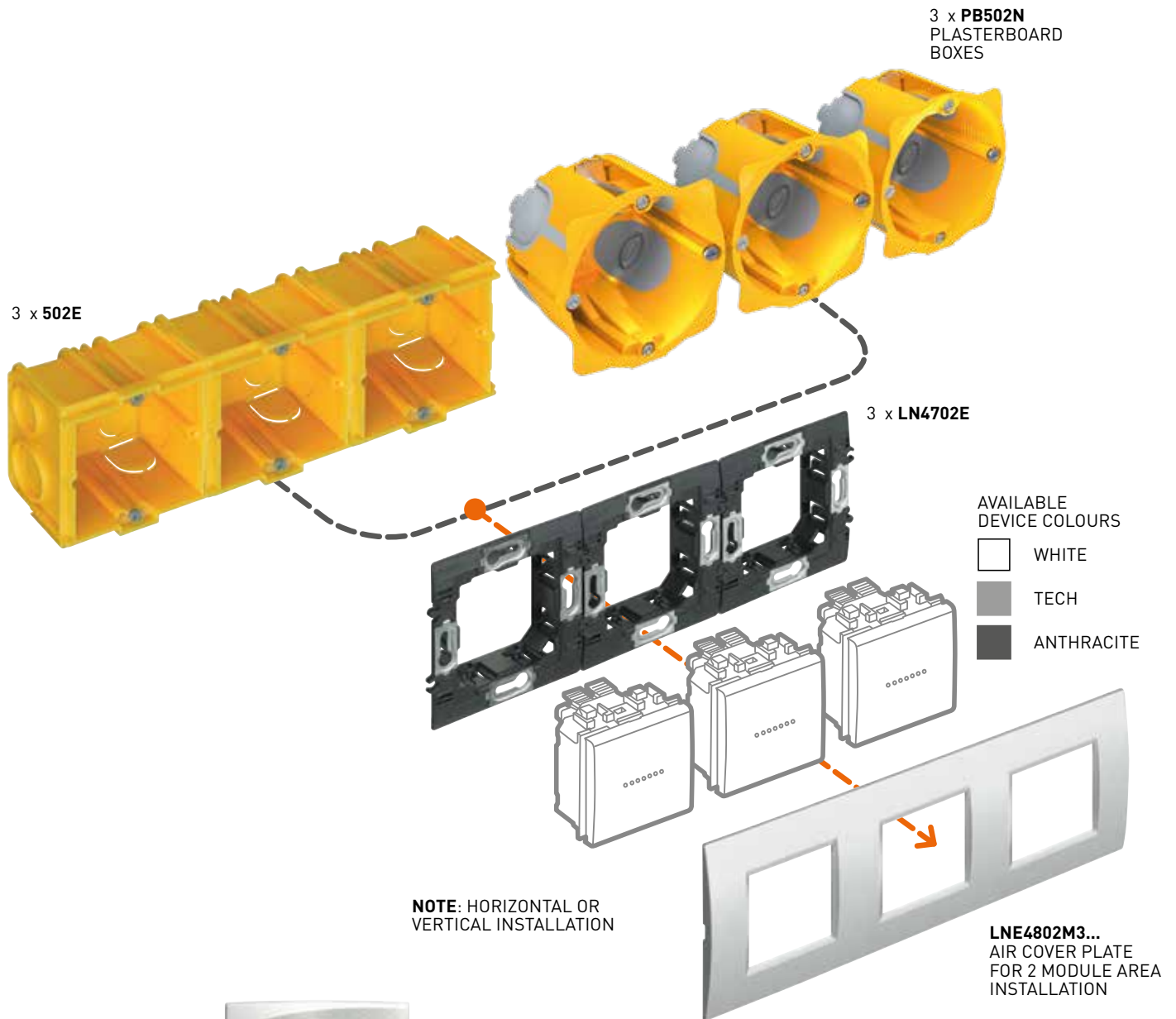

Livinglight AIR features reduced protrusion from the wall of the device/cover plate.

- 2 module installation: on BTicino boxes 502E and PB502N. Complete the installation with specific supports and cover plates.

Suggestions:

- new systems: considering the back position of the mechanisms inside the boxes, for masonry walls the use of box extensions is recommended, for better comfort and wiring





SMART ELECTRICAL SYSTEM

The offer advantages

A refined combination of shapes, colors, materials and surfaces to satisfy every type of aesthetic taste: from minimal to sophisticated.

FROM TRADITIONAL TO CONNECTED IN A FEW STEPS

Does your customer want a Smart system?

From today with LivingLight with Netatmo it is possible without redoing the wiring, with the only replacement of a few traditional devices with those connected.

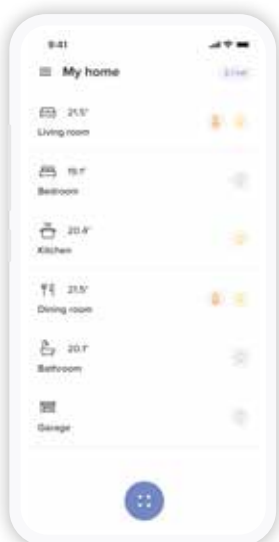







CATALOGUE

SMART ELECTRICAL SYSTEM - MODULAR VERSION

Controls for light and shutter







Item	CONNECTED DEVICES FOR LIGHT
<input type="checkbox"/> N4003C <input checked="" type="checkbox"/> NT4003C <input checked="" type="checkbox"/> L4003C	 <p>connected 2-ways switch. It allows to control lights locally or remotely. The connected 2ways switch has the same installation and usability of a traditional 2ways switch and it is compatible with all loads with max pover 250 W. It is equipped with a blue LED light used always on for localization modality or on, when the light is on for the load status modality. It can be associated with "wireless light switches". Caution: Must be connected to the neutral. Power supply 110-230 Va.c. - 1 module</p>
<input type="checkbox"/> N4411C <input checked="" type="checkbox"/> NT4411C <input checked="" type="checkbox"/> L4411C	 <p>dimmer/switch. It allows to control lights locally or remotely, with the dimmer functionality that can be activated from APP Home+Control. It has the same installation and usability of a traditional switch and it is compatible with all loads (LED, halogen) with max power 150 W at 230 V (or 75 W at 110 V). It is equipped with a blue LED light used for localization modality or load status modality, configurable by APP. It can be connected to one or more traditional push-button or associated with "wireless light switches". Caution: Must be connected to the neutral. Power supply 110-230 Va.c. - 1 module</p>
<input type="radio"/> 3584C	 <p>connected lighting micromodule. It allows to control lights locally or remotely. It is compatible with all loads with max pover 300 W. It can be connected to one or more traditional push-button or associated with "wireless light switches". It is installed as a traditional rele in the box (behind the button) or in derivation boxes. Caution: Must be connected to the neutral. Power supply 110-230 Va.c.</p>
<input type="radio"/> FC80RC	 <p>DIN switchboard light device for loads with absorption In= 16 A. Equipped with a meter measuring the current absorbed by the load and contacts for control with up to 10 pushbuttons. Power supply 110-230 Va.c. - 1 DIN module.</p>

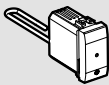

Item	CONNECTED DEVICES FOR SHUTTERS
<input type="checkbox"/> N4027C <input checked="" type="checkbox"/> NT4027C <input checked="" type="checkbox"/> L4027C	 <p>connected rolling shutter switch - It allows the control of a shutter locally or remotely. Compatible with all standard rolling shutter motors (with a mechanical or electromechanical stop and max power 500 VA) controlled by a wired shutter switch (switching of the same motor power supply). Not compatible with motors for radio-controlled or pulse-controlled roller shutters. It can be associated with one or more wireless commands. Caution: Must be connected to the neutral. Power supply 110-230 Va.c. - 1 module</p>
<input type="checkbox"/> N4027CIL <input checked="" type="checkbox"/> NT4027CIL <input checked="" type="checkbox"/> L4027CIL	 <p>As above - interlocked modality</p>
<input type="radio"/> 4027C	 <p>connected micromodule for shutters. Associated to one or more shutter wireless controls, it controls a shutter locally or remotely. Compatible with all standard shutter motors (with mechanical or electronic limit switch and maximum power 500 VA), controlled by a wired shutter changeover switch (changeover with the same power supply as the motor). Not compatible with radio controlled or pulse controlled shutter motors. It can be installed in the existing shutter box with no need of masonry works. Power supply 110-230 Va.c.</p>

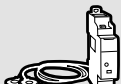
Controls for energy management and light



Item	CONNECTED DEVICES FOR ENERGY MANAGEMENT
<input type="checkbox"/> N4531C <input checked="" type="checkbox"/> NT4531C <input checked="" type="checkbox"/> L4531C	 <p>connected socket module - wiring to a power outlet, allows to remotely control appliances and check the consumption (instantaneous, daily, monthly). It is also possible to receive notifications in case of anomalous consumption. The connected socket module is compatible with any device electric and large appliances up to 16 A 3680 W max. (protected against overloads). It is equipped with a LED light lit in blue when it is on. This option can be enabled or disabled in the "Home+Control" app. It can be associated with "wireless light switches". Power supply 110-230 Va.c. - 1 module</p>
○ FC80CC	 <p>connected contactor for single-phase and/or three-phase loads with maximum absorption $I_n = 20$ A. With meter for the measurement of the current absorbed by the load. Power supply 110-230 Va.c. - 1 DIN module</p>
○ F20T60A	 <p>Smart DIN meter. It allows to measure the electrical energy consumption of the entire single-phase system of the house (instantaneous, daily, monthly) and of the single electrical power lines. It allows the reception of notifications in case of reaching the maximum power foreseen by the contract to avoid annoying black-outs. A toroid is supplied to measure the input current. Power supply 100-240 Va.c. - 1 DIN module. (Only for single-phase systems).</p>
○ F40T125A	 <p>DIN Smart meter as the item F20T60A but designed for measurement in three-phase systems</p>
○ FC80AC	 <p>Smart device for controlling and measuring the consumption of equipment fitted with dry contacts. Rating 12V/30Vdc or 230Vac 2A max. Ideal for controlling and measuring heating appliances, wallboxes and electric vehicle charging stations, ventilation systems, irrigation systems and any other device with a control dry contact. Not suitable for shutter automation. A toroid is supplied, for the measurement of the current absorbed by the load, max 80A. Function management through the Home + Control App, compatible with load management module FC80GCS. 1 DIN module. 100-240V a.c. power supply 50/60 Hz. Requires a Zigbee gateway.</p>

Item	CONNECTED DEVICES FOR ENERGY MANAGEMENT
FC80GCS	 <p>connected DIN load management module for the monitoring of the consumptions of the whole electric system, the powering or disconnection of the loads, and the setting of scenarios with priority or non-priority loads. When the maximum intended power is reached, the non-priority loads are temporarily disconnected to avoid black-outs. A toroid for the current reading is provided. Power supply 110-230 Va.c. - 1 DIN module</p>

CONNECTED PLUG&PLAY SOCKET	
Directly connected to an existing socket, it allows remote control of all the connected electrical appliances. It also monitors the instantaneous, daily and monthly consumption. Compatible with all the devices with power up to 16 A 3680 W (with overload protection). It can be associated to wireless light controls. Power supply 110-230 V Va.c.	
○ 4141PC	 <p>Shuko standard socket</p>
○ 4142PC	 <p>French / Belgian standard socket</p>

WIRELESS CONTROLS FOR LIGHT	
○ 3585C	 <p>it controls one or more devices connected for light control. Infrared detection with angle of 140°. Distance of the adjustable sensor from 2 to 8 m. Switch off delay with 1 to 30 min adjustable delay time and 1 to 1000 lux brightness threshold. Test possible with a 5 sec. delay. Recommended assembly height: 2.5 m. Optimum distance between 2 detectors: 6 m. For indoor and outdoor use (IP44). Supplied with 2 1.5V AA batteries for power supply.</p>

SMART ELECTRICAL SYSTEM - MODULAR VERSION

Wireless controls for light, shutter and scenario



Item	WIRELESS CONTROLS FOR LIGHT	
○ LN4003CWI (*)		wireless light switch. It allows the ON / OFF and dimming control of one or more connected devices for the lighting control. It can be installed in any flush-mounted box without any wiring. The battery can be replaced without removing it from the supporting frame. Integrated LED for low battery indication. Powered by battery 3V type CR2032 (supplied) with an autonomy of 8 years - 1 module
□ N4003CW ■ NT4003CW ■ L4003CW		wireless controls for light, as above. Surface installation with repositionable stickers (supplied) or onto a flush mounting box. - 2 modules.
□ N4003DCW ■ NT4003DCW ■ L4003DCW		wireless light switch. It is equipped with two buttons to control two different connected devices for lights. Each single button can be associated with one or more devices. Surface installation with repositionable stickers (supplied) or onto a flush mounting box. Integrated LED for low battery indication. Powered by battery 3V type CR2032 (supplied) with an autonomy of 8 years - 2 modules
○ 3577C		Wireless module for mechanical switch. It allows to change a traditional two-way switch or a pushbutton into a wireless light control for one connected device for light control (ON/OFF). The small size allows the installation in the flush mounted box. CR2032 type 3V power battery with 8 year expected life supplied (as standard)

WIRELESS CONTROLS FOR SHUTTER		
○ LN4027CWI (*)		rolling shutter wireless switch - It allows the control of one or more connected rolling shutter switches. It can be installed in any flush-mounted box without any wiring. The battery can be replaced without removing it from the supporting frame. Integrated LED for low battery indication. Powered by battery 3V type CR2032 (supplied) with an autonomy of 8 years - 1 module
□ N4027CW ■ NT4027CW ■ L4027CW		rolling shutter wireless switch - It allows the control of one or more connected rolling shutter switches. Surface installation with repositionable stickers (supplied) or onto a flush mounting box. Integrated LED for low battery indication. Powered by battery 3V type CR2032 (supplied) with an autonomy of 8 years - 2 modules

WIRELESS 4 SCENARIOS CONTROL		
□ N4575CW ■ NT4575CW ■ L4575CW		it's equipped with 4 buttons for activating of scenarios 1,2,3 and 4. Scenarios can be customized by the Home+ Control app. Surface installation with repositionable stickers (supplied) or onto a flush mounting box. Integrated LED for low battery indication. Powered by battery 3V type CR2032 (supplied) with an autonomy of 8 years - 2 modules.

WIRELESS HOME/AWAY SCENARIO CONTROLS		
○ LN4570CWI (*)		Home / Away wireless switch. It is equipped with 2 buttons for activating Home / Away scenarios Scenarios can be customized by the Home + Control app. It can be installed in any flush-mounted box without any wiring. The battery can be replaced without removing it from the supporting frame. Integrated LED for low battery indication. Powered by battery 3V type CR2032 (supplied) with an autonomy of 8 years - 1 module
□ N4570CW ■ NT4570CW ■ L4570CW		Home / Away wireless switch. It is equipped with 2 buttons for activating Home / Away scenarios Scenarios can be customized by the Home + Control app. Surface installation with repositionable stickers (supplied) or onto a flush mounting box. Integrated LED for low battery indication. Powered by battery 3V type CR2032 (supplied) with an autonomy of 8 years - 2 modules

WIRELESS WAKE UP/SLEEP SCENARIO CONTROLS		
○ LN4574CWI (*)		It is equipped with 2 buttons for activating Wake Up / Sleep scenarios. Scenarios can be customized by the Home + Control app. It can be installed in any flush-mounted box without any wiring. The battery can be replaced without removing it from the supporting frame. Integrated LED for low battery indication. Powered by battery 3V type CR2032 (supplied) with an autonomy of 8 years - 1 module
□ N4574CW ■ NT4574CW ■ L4574CW		It is equipped with 2 buttons for activating Wake Up / Sleep scenarios. Scenarios can be customized by the Home + Control app. Surface installation with repositionable stickers (supplied) or onto a flush mounting box. Integrated LED for low battery indication. Powered by battery 3V type CR2032 (supplied) with an autonomy of 8 years - 2 modules

(*) Mechanism provided with front covers in white, tech and anthracite color finishes

Note: for the use of connected devices, the gateway must be installed in the system.

Wireless controls for scenario and gateway

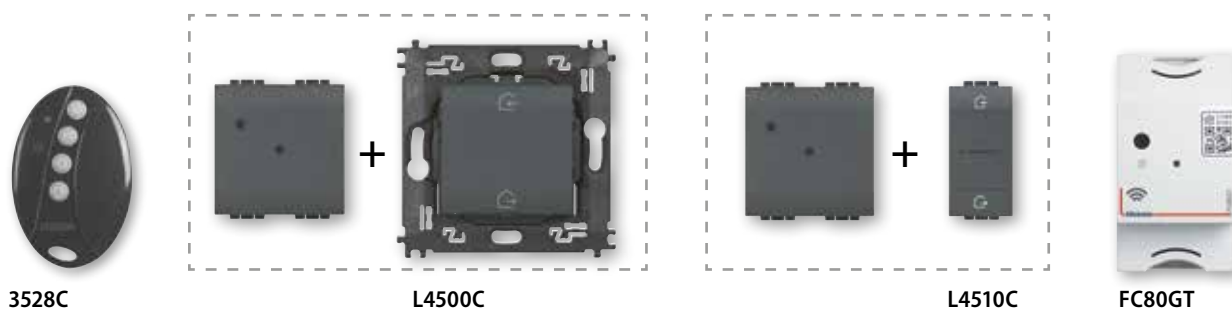

Item **POCKET REMOTE CONTROL 4 SCENARIOS**

3528C 

It allows to add a wireless remote control in your system. Is equipped with 4 keys for the activation of the 1,2,3 and 4 scenarios. The scenarios can be activated and customized by the Home + Control app. Integrated LED for low battery indication. Powered by battery 3V type CR2032 (supplied) with an autonomy of 8 years.

Item **GATEWAY DIN**

FC80GT 

The device enables to create a connected installation in the home and can be used to control lighting, roller shutters and electrical equipment plugged into connected sockets: - using your smartphone and the Home + Control app - using voice assistants - from the general control at the entrance to your home. Power supply 110-230 Va.c. - 2 modules.

GATEWAY

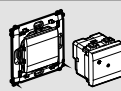
N4500C 

NT4500C

L4500C

Gateway. This pack enables to create a connected installation in the home. It can be used to control lighting, roller shutters and electrical equipment plugged into connected sockets:

- using your smartphone and the Home + Control app
- using voice assistants
- from the general control at the entrance to your home

Supplied with the Home/Away wireless master switch required for the association procedure of all connected devices. Power supply 110-230 Va.c. - 2 modules

N4510C 

NT4510C



L4510C



Gateway as above. Supplied with the flush-mounted Home/Away wireless master switch 1 module required for the association procedure of all connected devices. Power supply 110-230 Va.c. - 2 modules

SMART ELECTRICAL SYSTEM - EUROPE VERSION

Wired controls for light and shutter









Item	CONNECTED DEVICES FOR LIGHT
<input type="checkbox"/> N4411CM2 <input checked="" type="checkbox"/> NT4411CM2 <input checked="" type="checkbox"/> L4411CM2	 <p>dimmer/switch without neutral. It allows to control lights locally or remotely, with the dimmer functionality that can be activated from APP Home+Control.</p> <p>It has the same installation and usability of a traditional switch and it is compatible with all loads (LED, halogen) with power 5-300 W at 230 V. It is equipped with a blue LED light used for localization modality or load status modality, configurable by APP. It can be connected associated with "wireless light switches".</p> <p>It doesn't require connection to the neutral, it comes with an active compensator.</p> <p>Power supply 110-230 Va.c. - 2 modules</p>
<input type="checkbox"/> N4412CM2 <input checked="" type="checkbox"/> NT4412CM2 <input checked="" type="checkbox"/> L4412CM2	<p>dimmer/switch as above but with neutral.</p>
○ 3584C	 <p>connected lighting micromodule. It allows to control lights locally or remotely.</p> <p>It is compatible with all loads with max power 300 W. It can be connected to one or more traditional push-button or associated with "wireless light switches". It is installed as a traditional rele in the box (behind the button) or in derivation boxes.</p> <p>Caution: Must be connected to the neutral.</p> <p>Power supply 110-230 Va.c.</p>
○ FC80RC	 <p>DIN switchboard light device for loads with absorption $I_n = 16$ A. Equipped with a meter measuring the current absorbed by the load and contacts for control with up to 10 pushbuttons.</p> <p>Power supply 110-230 Va.c. - 1 DIN module.</p>



Item	CONNECTED DEVICES FOR SHUTTERS
<input type="checkbox"/> N4027CM2 <input checked="" type="checkbox"/> NT4027CM2 <input checked="" type="checkbox"/> L4027CM2	 <p>connected rolling shutter switch - It allows the control of a shutter locally or remotely.</p> <p>Compatible with all standard rolling shutter motors (with a mechanical or electromechanical stop and max power 500 VA) controlled by a wired shutter switch (switching of the same motor power supply). Not compatible with motors for radio-controlled or pulse-controlled roller shutters. It can be associated with one or more wireless commands.</p> <p>Caution: Must be connected to the neutral.</p> <p>Power supply 110-230 Va.c. - 2 modules</p>
○ 4027C	 <p>connected micromodule for shutters.</p> <p>Associated to one or more shutter wireless controls, it controls a shutter locally or remotely. Compatible with all standard shutter motors (with mechanical or electronic limit switch and maximum power 500 VA), controlled by a wired shutter changeover switch (changeover with the same power supply as the motor).</p> <p>Not compatible with radio controlled or pulse controlled shutter motors.</p> <p>It can be installed in the existing shutter box with no need of masonry works.</p> <p>Power supply 110-230 Va.c.</p>

Wired controls for energy management and light



Item	CONNECTED MODULE FOR ENERGY MANAGEMENT	
○ FC80CC		connected contactor for single-phase and/or three-phase loads with maximum absorption $I_n = 20$ A. With meter for the measurement of the current absorbed by the load. Power supply 110-230 Va.c. - 1 DIN module
○ F20T60A		Smart DIN meter. It allows to measure the electrical energy consumption of the entire single-phase system of the house (instantaneous, daily, monthly) and of the single electrical power lines. It allows the reception of notifications in case of reaching the maximum power foreseen by the contract to avoid annoying black-outs. A toroid is supplied to measure the input current. Power supply 100-240 Va.c. - 1 DIN module. (Only for single-phase systems).
○ F40T125A		DIN Smart meter as the item F20T60A but designed for measurement in three-phase systems
○ FC80GCS		connected DIN load management module for the monitoring of the consumptions of the whole electric system, the powering or disconnection of the loads, and the setting of scenarios with priority or non-priority loads. When the maximum intended power is reached, the non-priority loads are temporarily disconnected to avoid black-outs. A toroid for the current reading is provided Power supply 110-230 Va.c. - 1 DIN module

Item	CONNECTED PLUG&PLAY SOCKETS	
○ 4141PC		Shuko standard socket
○ 4142PC		French / Belgian standard socket

CONNECTED SOCKETS		
<input type="checkbox"/> N4141AC <input checked="" type="checkbox"/> NT4141AC <input checked="" type="checkbox"/> L4141AC		2P+E 16 A 250 Va.c. German standard connected socket. It allows remote control of electric devices and also to monitor their consumption (instantaneous, daily, monthly). It is also possible to receive notifications that can be configured. Compatible with all the electric devices with power up to 16 A 3680W (with overload protection). Integrated with a 2-module support, it can be installed instead of an existing socket in a 40 mm deep box. Screw fixing and connection using automatic clamps. It has a blue LED that lights up when the socket is ON and that can be configured by means of the Home + Control APP. It can be associated to one or more wireless light controls. Power supply 110-230 Va.c.
<input type="checkbox"/> N4142AC <input checked="" type="checkbox"/> NT4142AC <input checked="" type="checkbox"/> L4142AC		As above French/belgian standard socket

WIRELESS CONTROLS FOR LIGHT		
○ 3585C		it controls one or more devices connected for light control. Infrared detection with angle of 140°. Distance of the adjustable sensor from 2 to 8 m. Switch off delay with 1 to 30 min adjustable delay time and 1 to 1000 lux brightness threshold. Test possible with a 5 sec. delay. Recommended assembly height: 2.5 m. Optimum distance between 2 detectors: 6 m. For indoor and outdoor use (IP44). Supplied with 2 1.5V AA batteries for power supply.

SMART ELECTRICAL SYSTEM - EUROPE VERSION

Wireless controls for light, shutter and scenario



Item

N4003CW
 NT4003CW
 L4003CW

WIRELESS CONTROLS FOR LIGHT

wireless light switch. It allows the ON / OFF and dimming control of one or more connected devices for the lighting control. It can be installed in any flush-mounted box without any wiring. The battery can be replaced without removing it from the supporting frame. Integrated LED for low battery indication. Powered by battery 3V type CR2032 (supplied) with an autonomy of 8 years. Surface installation with repositionable stickers (supplied) or onto a flush mounting box. - 2 modules.

N4003DCW
 NT4003DCW
 L4003DCW

wireless light switch. It is equipped with two buttons to control two different connected devices for lights. Each single button can be associated with one or more devices. Surface installation with repositionable stickers (supplied) or onto a flush mounting box. Integrated LED for low battery indication. Powered by battery 3V type CR2032 (supplied) with an autonomy of 8 years - 2 modules

N4027CW
 NT4027CW
 L4027CW

WIRELESS CONTROLS FOR SHUTTER

rolling shutter wireless switch - It allows the control of one or more connected rolling shutter switches. Surface installation with repositionable stickers (supplied) or onto a flush mounting box. Integrated LED for low battery indication. Powered by battery 3V type CR2032 (supplied) with an autonomy of 8 years - 2 modules

N4575CW
 NT4575CW
 L4575CW

WIRELESS 4 SCENARIOS CONTROL

it's equipped with 4 buttons for activating of scenarios 1,2,3 and 4.Scenarios can be customized by the Home+ Control app. Surface installation withrepositionable stickers (supplied) or onto a flushmounting box.Integrated LED for low battery indication.Powered by battery 3V type CR2032 (supplied)with an autonomy of 8 years - 2 modules.

Item

N4570CW
 NT4570CW
 L4570CW

WIRELESS HOME/AWAY SCENARIO CONTROLS

Home / Away wireless switch. It is equipped with 2 buttons for activating Home / Away scenarios Scenarios can be customized by the Home + Control app. Surface installation with repositionable stickers (supplied) or onto a flush mounting box. Integrated LED for low battery indication. Powered by battery 3V type CR2032 (supplied) with an autonomy of 8 years - 2 modules

N4574CW
 NT4574CW
 L4574CW

WIRELESS WAKE UP/SLEEP SCENARIO CONTROLS

It is equipped with 2 buttons for activating Wake Up / Sleep scenarios. Scenarios can be customized by the Home + Control app. Surface installation with repositionable stickers (supplied) or onto a flush mounting box. Integrated LED for low battery indication. Powered by battery 3V type CR2032 (supplied) with an autonomy of 8 years - 2 modules

3528C

POCKET REMOTE CONTROL 4 SCENARIOS

It allows to add a wireless remote control in your system. Is equipped with 4 keys for the activation of the 1,2,3 and 4 scenarios. The scenarios can be activated and customized by the Home + Control app. Integrated LED for low battery indication. Powered by battery 3V type CR2032 (supplied) with an autonomy of 8 years.

(*) Mechanism provided with front covers in white, tech and and anthracite color finishes

Note: for the use of connected devices, the gateway must be installed in the system.

Gateway



Item

- N4501C
- NT4501C
- L4501C

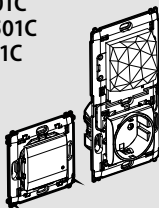

GATEWAY WITH SOCKET (GERMAN STANDARD)

German standard socket.

The gateway creates a connected installation in your home. It can be used to control lights, shutters, and electric appliances plugged into connected sockets:

- using the smartphone and the Home + Control app
- using the voice assistants
- from the general control at the home entrance.

It integrates a 2P+E 16 A 250 Va.c. German standard connected socket for the remote control of electric devices and to monitor their consumption (instantaneous, daily, monthly). Compatible with all the electric devices with power up to 16 A 3680W (with overload protection). It can be installed instead of an existing socket in a 40 mm deep box. Screw fixing and connection using automatic clamps

It has a blue LED that lights up when the socket is ON and that can be configured by means of the Home + Control APP. It can be associated to one or more wireless light controls. It is also supplied with wireless master IN&OUT scenario control, required for the association of all connected devices.

Power supply 110-230 Va.c.

Item

- N4502C
- NT4502C
- L4502C

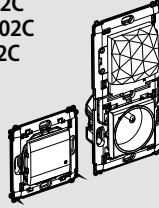

GATEWAY WITH SOCKET (F/B STANDARD)

French/belgian standard socket.

The gateway creates a connected installation in your home. It can be used to control lights, shutters, and electric appliances plugged into connected sockets:

- using the smartphone and the Home + Control app
- using the voice assistants
- from the general control at the home entrance.

It integrates a 2P+E 16 A 250 Va.c. French/belgian standard connected socket for the remote control of electric devices and to monitor their consumption (instantaneous, daily, monthly). Compatible with all the electric devices with power up to 16 A 3680W (with overload protection). It can be installed instead of an existing socket in a 40 mm deep box. Screw fixing and connection using automatic clamps

It has a blue LED that lights up when the socket is ON and that can be configured by means of the Home + Control APP. It can be associated to one or more wireless light controls. It is also supplied with wireless master IN&OUT scenario control, required for the association of all connected devices.

Power supply 110-230 Va.c.

GATEWAY DIN

- FC80GT



The device enables to create a connected installation in the home and can be used to control lighting, roller shutters and electrical equipment plugged into connected sockets:

- using your smartphone and the Home + Control app
- using voice assistants
- from the general control at the entrance to your home.

Power supply 110-230 Va.c. - 2 modules.

Smarter ^{WITH} Netatmo SMART ELECTRICAL SYSTEM

Thermostat



XW8002
XW8002W



XM8002



XG8002

Item

CONNECTED THERMOSTAT

- XW8002
- XG8002
- XM8002



The Smarter with Netatmo connected thermostat, together with the dedicated HOME+CONTROL APP, is a device which allows you to adjust and monitor the temperature in the rooms precisely and accurately; all the programming and most of the functions are performed simply and intuitively using the APP. Thanks to its Wi-Fi connection, Smarter with Netatmo can be programmed and controlled remotely; it can also display the temperature and humidity measured in the room. The temperature level can be set locally for manual operation and the Boost mode can be activated. The Boost forces the switching on of the system for a limited time (30, 60 or 90 minutes) independent of the measured and programmed temperature.

It's also possible to set a different temperature in each room of the house for the maximum comfort, thanks to its compatibility with Netatmo's smart radiator valves.

Smarter with Netatmo can also be controlled with Google, Amazon Alexa and Apple Home Kit voice assistants.

Features:

- 110 ÷ 230 Va.c., 50/60 Hz power supply;
- 2 W max absorption;
- maximum cable section 1 x 1.5mm²;
- temperature measurement 5 ÷ 40°C;
- temperature set-point 5 ÷ 40°C,
- increase of 0.5°C;
- 1-contact output in switching free of potential 5(2)A.

Types of installation:

- flush mounted, on boxes item 503E or 500 (for item 500 use the wall dowels)
- plasterboard, on boxes 2 module e 3 module

It is available in three colours: white (XW8002), sand (XM8002) and black (XG8002).

- XW8002W



features: as ..8002.

Installation: on the wall, using screws and dowels suitable for the installation surface (brickwork, plasterboard, tiles etc.). It is only available in white.

DIMENSIONAL DATA

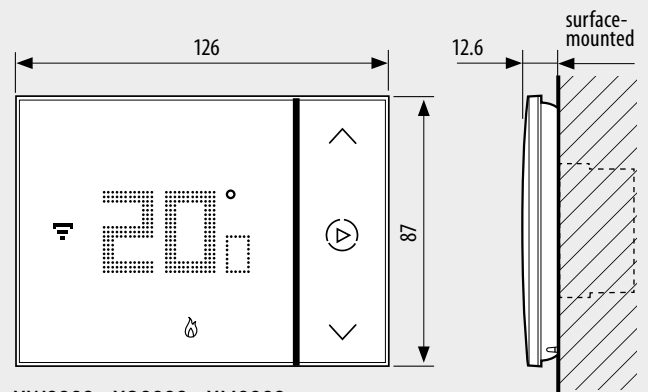

XW8002 - XG8002 - XM8002

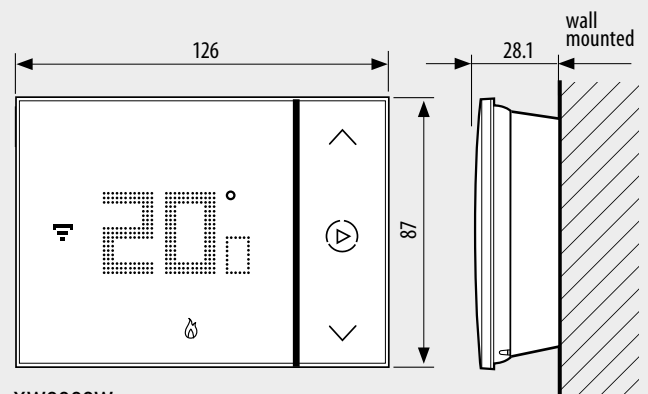

XW8002W

App HOME + CONTROL for
management of connected devices



DESIGN
AWARD
2017

Smarter, the connected thermostat, has been awarded this prestigious international recognition confirming BTicino's capacity in combining technology and design.



TRADITIONAL ELECTRICAL SYSTEM AND SMART ELECTRICAL SYSTEM

A refined combination of shapes, colors, materials and surfaces to satisfy every type of aesthetic taste: from minimal to sophisticated.



Livinglight

TRADITIONAL ELECTRICAL SYSTEM

Basic control devices

ROCKER CONTROLS



N4001N N4001M2N

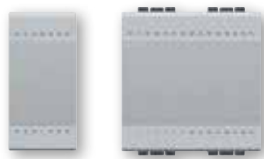

NT4001N NT4001M2N



L4001N L4001M2N L4001/0

Description	DEVICES WITH AUTOMATIC TERMINAL		DEVICES WITH SCREW & PLATE TERMINAL		
	1 module	2 modules	1 module	2 modules	
	Item	Item	Item	Item	
1 WAY SWITCH 1P 10AX 250 Va.c.	<input type="checkbox"/>	N4001A	N4001M2A	N4001N	N4001M2N
	<input type="checkbox"/>	NT4001A	NT4001M2A	NT4001N	NT4001M2N
	<input type="checkbox"/>	L4001A	L4001M2A	L4001N	L4001M2N
	<input type="checkbox"/>	LN4001A	-	L4001/0	-
2 WAY SWITCH 1P 10AX 250 VA.C.	<input type="checkbox"/>	N4003A	N4003M2A	N4003N	N4003M2N
	<input type="checkbox"/>	NT4003A	NT4003M2A	NT4003N	NT4003M2N
	<input type="checkbox"/>	L4003A	L4003M2A	L4003N	L4003M2N
	<input type="checkbox"/>	LN4003A	-	L4003/0	-
4 WAY SWITCH 1P 10AX 250 VA.C.	<input type="checkbox"/>	-	-	N4004N	N4004M2N
	<input type="checkbox"/>	-	-	NT4004N	NT4004M2N
	<input type="checkbox"/>	-	-	L4004N	L4004M2N
	<input type="checkbox"/>	-	-	LN4004	-
PUSHBUTTON 1P (NO) 10 A 250 Va.c.	<input type="checkbox"/>	N4005A	N4005M2A	N4005N	N4005M2N
	<input type="checkbox"/>	NT4005A	NT4005M2A	NT4005N	NT4005M2N
	<input type="checkbox"/>	L4005A	L4005M2A	L4005N	L4005M2N
	<input type="checkbox"/>	LN4005A	-	L4005/0	-

Note: neutral controls are supplied without key covers. They must be finished using the key covers listed in the following pages. The key covers of other controls may be replaced by those listed in the following pages.

AXIAL CONTROLS



N4051N N4051M2N



NT4051N NT4051M2N



L4051AN L4051M2AN

Description	DEVICES WITH AUTOMATIC TERMINAL		SCREW & PLATE TERMINAL		
	1 module	2 modules	1 module	2 modules	
	Item	Item	Item	Item	
1 WAY SWITCH 1P 10 AX 250 Va.c.	<input type="checkbox"/>	N4051AN	N4051M2AN	N4051N	N4051M2N
	<input type="checkbox"/>	NT4051AN	NT4051M2AN	NT4051N	NT4051M2N
	<input type="checkbox"/>	L4051AN	L4051M2AN	L4051N	L4051M2N
2 WAY 25 SWITCH 1P 10 AX 250 Va.c.	<input type="checkbox"/>	N4053AN	N4053M2AN	N4053N	N4053M2N
	<input type="checkbox"/>	NT4053AN	NT4053M2AN	NT4053N	NT4053M2N
	<input type="checkbox"/>	L4053AN	L4053M2AN	L4053N	L4053M2N
4 WAY SWITCH * 1P 10AX 250 VA.C.	<input type="checkbox"/>	-	-	N4054	N4054M2
	<input type="checkbox"/>	-	-	NT4054	NT4054M2
	<input type="checkbox"/>	-	-	L4054	L4054M2
PUSHBUTTON ** 1P (NO) 10 A 250 Va.c.	<input type="checkbox"/>	N4055AN	N4055M2AN	N4055N	N4055M2N
	<input type="checkbox"/>	NT4055AN	NT4055M2AN	NT4055N	NT4055M2N
	<input type="checkbox"/>	L4055AN	L4055M2AN	L4055N	L4055M2N

Note: The key covers of axial controls may be replaced by those listed in the following pages.

* axial intermediate switch are fitted with screw and plate terminals

** **Note:** for installation in the standard 3 module arrangement with AIR plate, in combination with the MH BASIC interface, the use of box extensions is recommended, as it will make wiring easier.

Livinglight ^{WITH} Netatmo

SMART ELECTRICAL SYSTEM

Connected control devices



L4003C



3577C

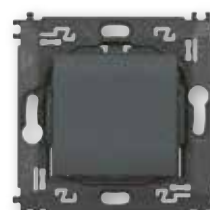

L4003CW

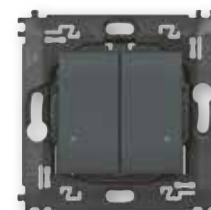

L4003DCW

Item	CONNECTED 2-WAY SWITCHES	
<input type="checkbox"/> N4003C <input type="checkbox"/> NT4003C <input type="checkbox"/> L4003C		<p>connected 2-ways switch. It allows to control lights locally or remotely. The connected 2-ways switch has the same installation and usability of a traditional 2ways switch and it is compatible with all loads with max power 250 W. It is equipped with a blue LED light used always on for localization modality or on, when the light is on for the load status modality. It can be associated with "wireless light switches".</p> <p>Caution: Must be connected to the neutral. Power supply 110-230 Va.c. - 1 module</p>

Articolo	WIRELESS CONTROLS FOR LIGHT	
○ LN4003CWI (*)		<p>wireless light switch. It allows the ON / OFF and dimming control of one or more connected devices for the lighting control. It can be installed in any flush-mounted box without any wiring. The battery can be replaced without removing it from the supporting frame. Integrated LED for low battery indication. Powered by battery 3V type CR2032 (supplied) with an autonomy of 8 years - 1 module</p>
<input type="checkbox"/> N4003CW <input type="checkbox"/> NT4003CW <input type="checkbox"/> L4003CW		<p>wireless controls for light, as above. Surface installation with repositionable stickers (supplied) or onto a flush mounting box. - 2 modules.</p>
<input type="checkbox"/> N4003DCW <input type="checkbox"/> NT4003DCW <input type="checkbox"/> L4003DCW		<p>wireless light switch. It is equipped with two buttons to control two different connected devices for lights. Each single button can be associated with one or more devices. Surface installation with repositionable stickers (supplied) or onto a flush mounting box. Integrated LED for low battery indication. Powered by battery 3V type CR2032 (supplied) with an autonomy of 8 years - 2 modules</p>
○ 3585C		<p>It controls one or more devices connected for light control. Infrared detection with angle of 140°. Distance of the adjustable sensor from 2 to 8 m. Switch off delay with 1 to 30 min adjustable delay time and 1 to 1000 lux brightness threshold. Test possible with a 5 sec. delay. Recommended assembly height: 2.5 m. Optimum distance between 2 detectors: 6 m. For indoor and outdoor use (IP44). Supplied with 2 1.5V AA batteries for power supply.</p>
○ 3577C		<p>Wireless module for mechanical switch. It allows to change a traditional two-way switch or a pushbutton into a wireless light control for one connected device for light control (ON/OFF). The small size allows, the installation in the flush mounted box. CR2032 type 3V power battery with 8 year expected life supplied (as standard).</p>

Note: for the use of the connected devices, the gateway, item ...4500C, ...4510C or FG80GT must be installed as part of the system.

If the gateway is connected to the internet through the Wi-Fi network, it will be possible to manage the system from the home using the specific **HOME + CONTROL** App



HOME + CONTROL



(*) Mechanism provided with front covers in white, tech and and anthracite color finishes

Livinglight

TRADITIONAL ELECTRICAL SYSTEM

Key covers for rocker controls

1 FUNCTION KEY COVERS



NEUTRAL LIGHTABLE KEY COVERS

		1 module	2 modules	3 modules
Description		Item	Item	Item
NEUTRAL KEY COVER WITH LIGHTABLE DIFFUSER	<input type="checkbox"/>	N4915N	N4915M2N	N4915M3N
	<input type="checkbox"/>	NT4915N	NT4915M2N	NT4915M3N
	<input type="checkbox"/>	L4915N	L4915M2N	L4915M3N
HIGH BRIGHTNESS COVER	<input type="checkbox"/>	N4915LN	N4915M2LN	N4915M3LN

Note: these key covers are suitable for installation on neutral control devices (supplied without key cover)



KEY COVERS WITH DIFFUSER AND LIGHTABLE SYMBOL

		1 module	2 modules
Description		Item	Item
KEY COVER WITH LIGHT SYMBOL	<input type="checkbox"/>	N4915AN	N4915M2AN
	<input type="checkbox"/>	NT4915AN	NT4915M2AN
	<input type="checkbox"/>	L4915AN	L4915M2AN
KEY COVER WITH STAIRCASE LIGHT SYMBOL	<input type="checkbox"/>	N4915BN	N4915M2BN
	<input type="checkbox"/>	NT4915BN	NT4915M2BN
	<input type="checkbox"/>	L4915BN	L4915M2BN
KEY COVER WITH BELL SYMBOL	<input type="checkbox"/>	N4915DN	N4915M2DN
	<input type="checkbox"/>	NT4915DN	NT4915M2DN
	<input type="checkbox"/>	L4915DN	L4915M2DN
KEY COVER WITH KEY SYMBOL	<input type="checkbox"/>	N4915FN	N4915M2FN
	<input type="checkbox"/>	NT4915FN	NT4915M2FN
	<input type="checkbox"/>	L4915FN	L4915M2FN
KEY COVER WITH DIMMER SYMBOL	<input type="checkbox"/>		N4915M2ADN
	<input type="checkbox"/>		NT4915M2ADN
	<input type="checkbox"/>		L4915M2ADN
KEY COVER WITH "DO NOT DISTURB" SYMBOL	<input type="checkbox"/>	N4915DD	N4915M2DD
	<input type="checkbox"/>	NT4915DD	NT4915M2DD
	<input type="checkbox"/>	L4915DD	L4915M2DD
KEY COVER WITH "REARRANGE THE ROOM" SYMBOL	<input type="checkbox"/>	N4915MR	
	<input type="checkbox"/>	NT4915MR	
	<input type="checkbox"/>	L4915MR	
KEY COVER WITH FAN SYMBOL	<input type="checkbox"/>	N4915RN	
	<input type="checkbox"/>	NT4915RN	
	<input type="checkbox"/>	L4915RN	
KEY COVER WITH HEATING SYMBOL	<input type="checkbox"/>	N4915PN	
	<input type="checkbox"/>	NT4915PN	
	<input type="checkbox"/>	L4915PN	
KEY COVER WITH BOILER SYMBOL	<input type="checkbox"/>	N4915SN	
	<input type="checkbox"/>	NT4915SN	
	<input type="checkbox"/>	L4915SN	



Note: these key covers are suitable for installation on neutral control devices (supplied without key cover), or as replacement for the original key covers supplied.

Note: for customisable key covers, using the diffusers supplied separately, see the MyHOME key cover section. Refer to 1 function customisable key covers.

Key covers for axial controls

NEUTRAL KEY COVERS LIGHTABLE			
		1 module	2 modules (*)
Description		Item	Item
NEUTRAL KEY COVER WITH LIGHTABLE DIFFUSER	<input type="checkbox"/>	N4916	N4916M2
	<input type="checkbox"/>	NT4916	NT4916M2
	<input type="checkbox"/>	L4916	L4916M2



NT4916

(*) Suitable only with new axial switches

KEY COVERS WITH DIFFUSER AND LIGHTABLE SYMBOL			
		1 module	2 modules (*)
Description		Item	Item
KEY COVER WITH LIGHT SYMBOL	<input type="checkbox"/>	N4916A	N4916M2A
	<input type="checkbox"/>	NT4916A	NT4916M2A
	<input type="checkbox"/>	L4916A	L4916M2A
KEY COVER WITH STAIRCASE LIGHT SYMBOL	<input type="checkbox"/>	N4916B	N4916M2B
	<input type="checkbox"/>	NT4916B	NT4916M2B
	<input type="checkbox"/>	L4916B	L4916M2B
KEY COVER WITH BELL SYMBOL	<input type="checkbox"/>	N4916D	N4916M2D
	<input type="checkbox"/>	NT4916D	NT4916M2D
	<input type="checkbox"/>	L4916D	L4916M2D
KEY COVER WITH KEY SYMBOL	<input type="checkbox"/>	N4916F	N4916M2F
	<input type="checkbox"/>	NT4916F	NT4916M2F
	<input type="checkbox"/>	L4916F	L4916M2F



NT4916A



NT4916B



NT4916D



NT4916F

Note: these key cover may be used to replace the original ones supplied with the product

(*) Suitable only with new axial switches

KEY COVERS THAT CAN BE CUSTOMISED USING THE DIFFUSER KITS			
		1 module	2 modules (*)
Description		Item	Item
KEY COVERS THAT CAN BE CUSTOMISED USING THE DIFFUSERS	<input type="checkbox"/>	N4916T	N4916M2T
	<input type="checkbox"/>	NT4916T	NT4916M2T
	<input type="checkbox"/>	L4916T	L4916M2T



NT4916T



NT4916M2T

Note: these key cover may be used to replace the original ones supplied with the product

(*) Suitable only with new axial switches

DIFFUSER KIT		
Description DIFFUSERS	Item	
KIT COMPOSITION AS SHOWN ON THE SIDE (5 EACH TYPE)	<input type="checkbox"/>	N4916KIT
	<input type="checkbox"/>	NT4916KIT
	<input type="checkbox"/>	L4916KIT

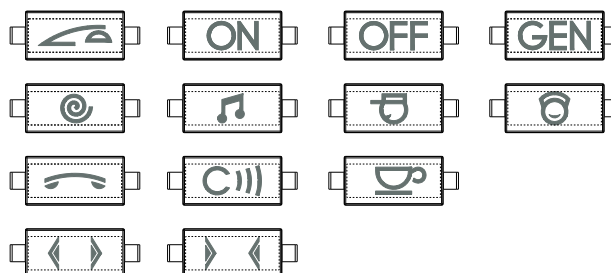

Livinglight TRADITIONAL ELECTRICAL SYSTEM

Relays



N4330/230



N4T330/230



L4330/230

Dimmers



N4402N



NT4406



NT4408N
NT4410N
NT4411N



L4581

Item		MONOSTABLE RELAYS
□ N4330/230 ■ NT4330/230 ■ L4330/230		monostable relay with NO/NC contact 250 Va.c. 10 A (resistive) 4 A (inductive) cosφ 0.5 coil power supply 230 Va.c.
□ N4330/12 ■ NT4330/12 ■ L4330/12		as above – coil power supply 12 Va.c.
□ N4330/24 ■ NT4330/24 ■ L4330/24		as above – coil power supply 24 Va.c.

Item		KNOB DIMMER
□ N4402N* ■ NT4402N* ■ L4402N*		knob dimmer with built-in two way switch - resistive 60-500 W - TRIAC/IGBT technology - built-in fuse - 1 module
□ N4406* ■ NT4406* ■ L4406*		resistive knob dimmer 100-500 W - 1 module
□ N4581 ■ NT4581 ■ L4581		resistive knob dimmer 400/800 W - 1 modules

*NOTE: when installing dimmers with AIR plates, for optimum look result and planarity of the light point, the use of the new pushbutton dimmers is recommended (E.g. L/N/NT4411N). Alternatively, if installing the L/N/NT4002N and L/N/NT4406, the use of the box extension is recommended, as it will make wiring easier.

Item		TOUCH DIMMER
□ N4408N ■ NT4408N ■ L4408N		resistive/inductive touch dimmer 300/600 W with electronic protection - 2 modules
□ N4410N ■ NT4410N ■ L4410N		touch dimmer output 0 - 10 V with electronic protection - 2 modules
□ N4582N ■ NT4582N ■ L4582N		resistive/capacitive touch dimmer 400/700 W - 2 modules
□ N4411N ■ NT4411N ■ L4411N		UNIVERSAL PUSHBUTTON DIMMER universal dimmer (resistive - inductive, capacitive, fluorescent compact and dimmer LEDs) - 150/200/400 W with electronic protection - 2 modules

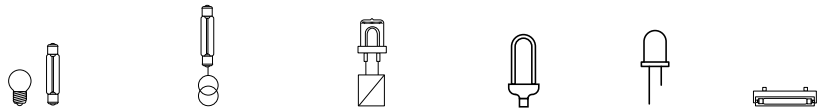

Loads

Item	Type	range	supply std	Incandescents and halogens	Halogens with ferromagnetic transformer	Halogens with electronic transformer	Dimmerable compact fluorescents	Dimmerable LED lamps	Fluorescents with electronic 0-10 V ballast
N4402N NT4402N L4402N	Resistive	230 Va.c. 50 Hz	230 Va.c.	60 - 500 W					
N4406 NT4406 L4406	Resistive	230 Va.c. 50 - 60 Hz	230 Va.c.	100 - 500 W					
N4408N NT4408N L4408N	Resistive Inductive	100 - 240 Va.c. 50 - 60 Hz	240 Va.c. 100 Va.c.	20 - 600 W 20 - 300 W	20 - 600 VA 20 - 300 VA				
N4410N NT4410N L4410N	0 - 10 V	100 - 240 Va.c. 50 - 60 Hz	240 Va.c. 100 Va.c.						20 - 600 VA 20 - 300 VA
N4411N NT4411N L4411N	Universal	100÷240 Va.c. 50÷60 Hz	240 Va.c. 100 Va.c.	3 ÷ 400 W 3 ÷ 200 W	3 ÷ 400 VA 3 ÷ 200 VA	3 ÷ 400 VA 3 ÷ 200 VA	3 - 150 VA 3 - 75 VA	3 - 150 VA 3 - 75 VA	
N4581 NT4581 L4581	Resistive	110 - 230 Va.c. 50 - 60 Hz	230 Va.c. 127 Va.c.	50 - 800 W 50 - 400 W					
N4582N NT4582N L4582N	Resistive Capacitive	110 - 230 Va.c. 50 - 60 Hz	127 Va.c. 230 Va.c.	50 - 400 W 50 - 700 W	50 - 400 W 50 - 700 W		50 - 300 W 50 - 300 W		100 - 300 W 100 - 500 W

Livinglight ^{WITH} Netatmo

SMART ELECTRICAL SYSTEM

Connected relays



Item	CONNECTED RELAYS	
○ 3584C		<p>Connected lighting micromodule. It allows to control lights locally or remotely. It is compatible with all loads with max power 300 W. It can be connected to one or more traditional push-button or associated with "wireless light switches". It is installed as a traditional relay in the box (behind the button) or in derivation boxes. Caution: Must be connected to the neutral. Power supply 110-230 Va.c.</p>
○ FC80RC		<p>DIN switchboard light device for loads with absorption In= 16 A. Equipped with a meter measuring the current absorbed by the load and contacts for control with up to 10 pushbuttons. Power supply 110-230 Va.c. - 1 DIN module.</p>

WIRELESS CONTROLS FOR LIGHT		
○ LN4003CWI (*)		<p>wireless light switch. It allows the ON / OFF and dimming control of one or more connected devices for the lighting control. It can be installed in any flush-mounted box without any wiring. The battery can be replaced without removing it from the supporting frame. Integrated LED for low battery indication. Powered by battery 3V type CR2032 (supplied) with an autonomy of 8 years - 1 module</p>
□ N4003CW ■ NT4003CW ■ L4003CW		<p>wireless controls for light, as above. Surface installation with repositionable stickers (supplied) or onto a flush mounting box. - 2 modules.</p>
□ N4003DCW ■ NT4003DCW ■ L4003DCW		<p>wireless light switch. It is equipped with two buttons to control two different connected devices for lights. Each single button can be associated with one or more devices. Surface installation with repositionable stickers (supplied) or onto a flush mounting box. Integrated LED for low battery indication. Powered by battery 3V type CR2032 (supplied) with an autonomy of 8 years - 2 modules</p>
○ 3577C		<p>wireless module for mechanical switch. It allows to change a traditional two-way switch or a pushbutton into a wireless light control for one connected device for light control (ON/OFF). The small size allows, the installation in the flush mounted box. CR2032 type 3V power battery with 8 year expected life supplied (as standard).</p>

Connected dimmers

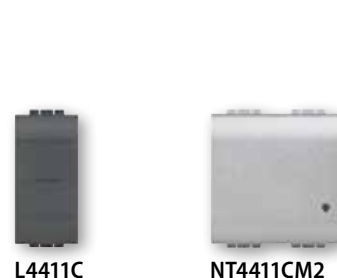

Item	CONNECTED DIMMER	
□ N4411C ■ NT4411C ■ L4411C		<p>Dimmer/switch. It allows to control lights locally or remotely, with the dimmer functionality that can be activated from APP Home+Control. It has the same installation and usability of a traditional switch and it is compatible with all loads (LED, halogen) with max power 150 W at 230 V (or 75 W at 110 V). It is equipped with a blue LED light used for localization modality or load status modality, configurable by APP. It can be connected to one or more traditional push-button or associated with "wireless light switches". Caution: Must be connected to the neutral. Power supply 110-230 Va.c. - 1 module</p>
□ N4411CM2 ■ NT4411CM2 ■ L4411CM2		<p>Dimmer/switch without neutral. It allows to control lights locally or remotely, with the dimmer functionality that can be activated from APP Home+Control. It has the same installation and usability of a traditional switch and it is compatible with all loads (LED, halogen) with power 5-300 W at 230 V. It is equipped with a blue LED light used for localization modality or load status modality, configurable by APP. It can be connected associated with "wireless light switches". It doesn't require connection to the neutral, it comes with an active compensator. Power supply 110-230 Va.c. - 2 modules</p>

Note: for the use of the connected devices, the gateway, item ...4500C, ...4510C or FG80GT must be installed as part of the system.

If the gateway is connected to the internet through the Wi-Fi network, it will be possible to manage the system from the home using the specific **HOME + CONTROL** App

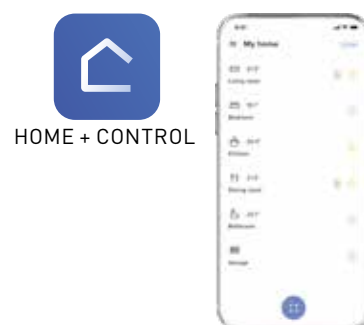

Livinglight

TRADITIONAL ELECTRICAL SYSTEM

IR and Green switches



N4433N



N4434N

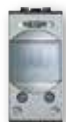

NT4431N



L4432

Item		PASSIVE IR SWITCHES
<input type="checkbox"/> N4431N <input type="checkbox"/> NT4431N <input type="checkbox"/> L4431N		Zero crossing technology Green Switch, multiloading neutral connection. Switch with presence sensor by means of the combination of passive infrared rays and ultrasounds and brightness. Manual switching on of the light by front pushbutton and automatic switching off as a function of the brightness level and presence. Timing to delay switching off and brightness sensor threshold settable by means of mono/bidirectional remote control (BMS04003 and BMS04001). Power supply 230 Vac - relay output from 2.1 to 8.5 A max - 2 modules
<input type="checkbox"/> N4432 <input type="checkbox"/> NT4432 <input type="checkbox"/> L4432		as above - switch off delay time circuit, with delay adjustment from 30 seconds to 10 minutes - it can also be activated using the external pushbutton - relay output 6 A resistive/2 A inductive - with 0-A-I selector - power supply 230 Va.c.- 2 modules
<input type="checkbox"/> N4432/127 <input type="checkbox"/> NT4432/127 <input type="checkbox"/> L4432/127		as above - 110/127 Va.c.

		GREEN SWITCH AND IR SENSOR
<input type="checkbox"/> N4433N <input type="checkbox"/> NT4433N <input type="checkbox"/> L4433N		Green Switch: switch with movement sensor, through a combination of passive infrared rays and ultrasounds , and brightness sensor. Manual switching on of the light using the front pushbutton, and automatic switching off based on brightness levels and movement. Switch off delay and brightness sensor threshold adjustable using the one/two-way (BMS04003 and BMS04001) remote control, 230 Va.c. power supply. - 2.5 A relay output - 2 modules
<input type="checkbox"/> N4434N <input type="checkbox"/> NT4434N <input type="checkbox"/> L4434N		Green Switch: switch with passive infrared rays presence sensor, and brightness sensor. Manual switching on of the light using the front pushbutton, and automatic switching off based on brightness level and presence. Switch off delay and brightness sensor threshold adjustable using the potentiometer and the one/two-way (BMS04003 and BMS04001) commissioning tools. Power supply 230 Vac and 1.7 A max relay output - 2 modules.

NOTE: for more information on remote controls BMS04003 and BMS04001 refer to the Lighting Management Catalogue.

GREEN SWITCH - FEATURES

	N4433N NT4433N L4433N	N4434N NT4434N L4434N
	100-240 V~	
	50/60 Hz	
	2 x 2.5 mm ²	
NEUTRAL CONNECTION	YES	NO
	(-5) - (+45) °C	
	300 lux	
	15 minutes	
	2000 W - 230 V~ 1000 W - 110 V~	40÷400 W - 230 V~ 20÷200 W - 110 V~
	1000 VA - 230 V~ - 4,3 A 500 VA - 110 V	40÷400 VA - 230 V~ 20÷200 VA - 110 V~
	10 x (2x36 W) - 230 V~ 5 x (2x36 W) - 110 V~	
	500 VA - 230 V~ 250 VA - 110 V~	
	1000 VA - 230 V~ 500 VA - 110 V~	
	500 VA - 230 V~ 250 VA - 110 V~	

Livinglight ^{WITH} Netatmo

SMART ELECTRICAL SYSTEM

Connected IR switches



3585C

Item	MOTION SENSOR WIRELESS
<p>○ 3585C</p> 	<p>It controls one or more devices connected for light control. Infrared detection with angle of 140°. Distance of the adjustable sensor from 2 to 8 m. Switch off delay with 1 to 30 min adjustable delay time and 1 to 1000 lux brightness threshold. Test possible with a 5 sec. delay. Recommended assembly height: 2.5 m. Optimum distance between 2 detectors: 6 m. For indoor and outdoor use (IP44). Supplied with 2 1.5V AA batteries for power supply.</p>

Note: for the use of the connected devices, the gateway, item ...**4500C**, ...**4510C** or **FG80GT** must be installed as part of the system.

If the gateway is connected to the internet through the Wi-Fi network, it will be possible to manage the system from the home using the specific **HOME + CONTROL** App



HOME + CONTROL



Livinglight

TRADITIONAL ELECTRICAL SYSTEM

Basic control devices



N4003ES



NT4003ES



L4003ES

Item

- N4003ES
- NT4003ES
- L4003ES



TWO-WAY ENERGY SAVING SWITCH

Two-way Energy Saving switch with presence detector. It works as a traditional 2 way switch (manual ON, manual OFF) but it will automatically turn off the light if it doesn't detect any presence for 10 minutes.

IR detection range, 8 meters, 160° - it is suitable with all type of loads that can be mixed on the same line:

- 12-150W: halogen or resistive loads
- 2-150VA: lamps with electronic or ferromagnetic ballast
- 8-30W (or 650 mA): LEDs or CFLs

Particularly suitable for places where a light can stay switched on for a long time such as garage and cellar, children's room, etc.

No neutral wiring, 127-230V, 2 modules.

TWO WAY ENERGY SAVING SWITCH WIRING DIAGRAM



Two-way energy saving switch

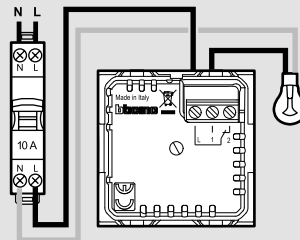

Two-way switch + Two-way energy saving switch

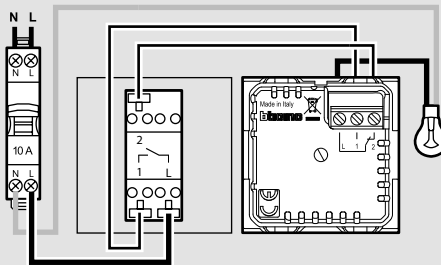

The IR sensor is activated when the light is switched on from one of the two switches. The two-way energy saving can be installed both near or far from the load and it opens the circuit after 10 minutes with no movement detection.

2 Two-way energy saving switches

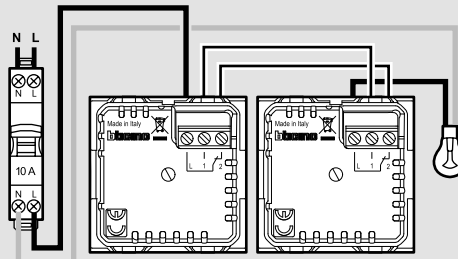

The IR sensor of the two switches are both activated when the light is switched on. The light will switch off when one of the two switches stays 10 minutes with no movement detection.

Other control devices



N4002N N4012 N4011



NT4027 NT4391 NT4016

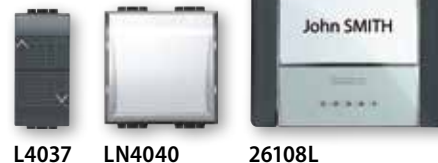

L4037 LN4040 26108L



NT4022 NT4033



L4038R L4038V

Item	16 AX 250 Va.c. SWITCHES
<input type="checkbox"/> N4002N <input type="checkbox"/> NT4002N <input type="checkbox"/> L4002N	2 P switch
<input type="checkbox"/> N4012 <input type="checkbox"/> NT4012 <input type="checkbox"/> L4012	2P key switch - the key can be removed both in the ON and in the OFF position – keys are different from each other
<input type="checkbox"/> N4012C* <input type="checkbox"/> NT4012C* <input type="checkbox"/> L4012C*	2P key switch - as above - keys are the same for all devices

*NOTE: item available to order. Contact your supplier for availability

Item	32 A DOUBLE-POLE SWITCH
<input type="checkbox"/> N4011 <input type="checkbox"/> NT4011 <input type="checkbox"/> L4011	32 A - 250 Va.c. 2 P switch

Item	16 AX 250 Va.c. TWO-WAY SWITCH
<input type="checkbox"/> N4022 <input type="checkbox"/> NT4022 <input type="checkbox"/> L4022	1 P key two-way switch - the key can be removed both in the ON and in the OFF position – keys are different from each other
<input type="checkbox"/> N4022C* <input type="checkbox"/> NT4022C* <input type="checkbox"/> L4022C*	1 P key two-way switch - as above - keys are the same for all devices

*NOTE: item available to order. Contact your supplier for availability

Item	JACK CONNECTOR
<input type="checkbox"/> N4391 <input type="checkbox"/> NT4391 <input type="checkbox"/> L4391	jack connector with 2 closing contacts 48 V 10 A (for plug item 2124N)
<input type="checkbox"/> 2124N	plug/jack for item L/N/NT4391

Item	ROTARY SWITCH
<input type="checkbox"/> N4016 <input type="checkbox"/> NT4016 <input type="checkbox"/> L4016	selector – 1 way rotary switch – 4 positions for controlling air conditioners, fans control, etc. - 3 A 250 Va.c.

Item	10 A 250 Va.c. PUSHBUTTONS
<input type="checkbox"/> N4034N <input type="checkbox"/> NT4034N <input type="checkbox"/> L4034N	1 P (NC) opening pushbutton preset for interchangeable key covers
<input type="checkbox"/> N4033 <input type="checkbox"/> NT4033 <input type="checkbox"/> L4033	1 P (NO) cord pushbutton
<input type="checkbox"/> N4038R <input type="checkbox"/> NT4038R <input type="checkbox"/> L4038R	1 P (NO) pushbutton + lampholder for LEDs item LN4742V12T - LN4742V127T - LN4742V230T - red diffuser
<input type="checkbox"/> N4038V <input type="checkbox"/> NT4038V <input type="checkbox"/> L4038V	as above - green diffuser
<input type="checkbox"/> N4044N <input type="checkbox"/> NT4044N <input type="checkbox"/> L4044N	2 P (NO) pushbutton with independent contacts for traditional hospital systems
<input type="checkbox"/> LN4040	1 P (NO) pushbutton + lightable nameplate with LEDs item LN4742V12T - LN4742V127T - LN4742V230T
<input type="checkbox"/> N4042N <input type="checkbox"/> NT4042N <input type="checkbox"/> L4042N	1 P (NO) pushbutton marked with lightable bell symbol
<input type="checkbox"/> N4042M2N <input type="checkbox"/> NT4042M2N <input type="checkbox"/> L4042M2N	1 P (NO) pushbutton marked with lightable bell symbol - 2 mod.
<input type="checkbox"/> N4043N <input type="checkbox"/> NT4043N <input type="checkbox"/> L4043N	1 P (NO) pushbutton marked with lightable lamp symbol
<input type="checkbox"/> N4043M2N <input type="checkbox"/> NT4043M2N <input type="checkbox"/> L4043M2N	1 P (NO) pushbutton marked with lightable lamp symbol - 2 mod.
<input type="checkbox"/> 26108N <input type="checkbox"/> 26108T <input type="checkbox"/> 26108L	IP55 nameplate pushbutton - backlit with LED technology (included) - suitable for installation on 503E and 502E flush mounted boxes

Item	KEY COVERS
<input type="checkbox"/> N4916DP <input type="checkbox"/> NT4916DP <input type="checkbox"/> L4916DP	neutral key cover for items N/NT/L4036, N/NT/L4038R, N/NT/L4038V - 10 pcs pack
<input type="checkbox"/> N4916DPA <input type="checkbox"/> NT4916DPA <input type="checkbox"/> L4916DPA	key cover with arrow symbol for items N/NT/L4027, N/NT/L4037 - 10 pcs pack

Livinglight

TRADITIONAL ELECTRICAL SYSTEM

Control for shutters



L4037N



NT4027N



NT4027VMCN

Item

16 A 250 Va.c. CHANGEOVER SWITCH

- N4027N
- NT4027N
- L4027N



1 P 1-0-2 double-key changeover switch

- N4027VMCN
- NT4027VMCN
- L4027VMCN



as above - fan symbol

10 A 250 Va.c. PUSHBUTTONS

- N4036N
- NT4036N
- L4036N



1 P (NO) + 1 P (NO) double pushbutton

- N4037N
- NT4037N
- L4037N



1 P (NO) + 1 P (NO) interlocked double pushbutton

Livinglight ^{WITH} Netatmo

SMART ELECTRICAL SYSTEM

Connected control for shutters

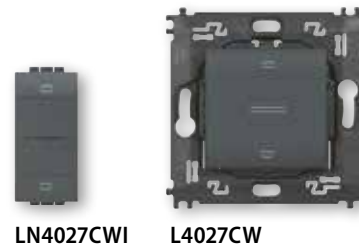
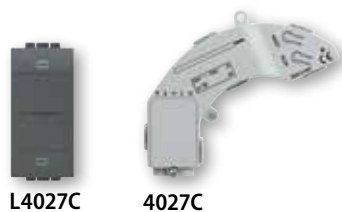

Item	CONNECTED DEVICES FOR SHUTTERS	
<input type="checkbox"/> N4027C <input type="checkbox"/> NT4027C <input type="checkbox"/> L4027C		connected rolling shutter switch - It allows the control of a shutter locally or remotely. Compatible with all standard rolling shutter motors (with a mechanical or electromechanical stop and max power 500 VA) controlled by a wired shutter switch (switching of the same motor power supply). Not compatible with motors for radio-controlled or pulse-controlled roller shutters. It can be associated with one or more wireless commands. Caution: Must be connected to the neutral. Power supply 110-230 Va.c. - 1 module
<input type="checkbox"/> N4027CIL <input type="checkbox"/> NT4027CIL <input type="checkbox"/> L4027CIL		as above - interlocked modality
<input type="checkbox"/> N4027CM2 <input type="checkbox"/> NT4027CM2 <input type="checkbox"/> L4027CM2		connected rolling shutter switch - It allows the control of a shutter locally or remotely. Compatible with all standard shutter motors (with mechanical or electronic limit switch and maximum power 500 VA), controlled by a wired shutter changeover switch (changeover with the same power supply as the motor). Not compatible with radio controlled or pulse controlled shutter motors. It can be associated to one or more wireless controls. Power supply 100-240 Va.c. - 2 modules
<input type="radio"/> 4027C		connected micromodule for shutters. Associated to one or more shutter wireless controls, it controls a shutter locally or remotely. Compatible with all standard shutter motors (with mechanical or electronic limit switch and maximum power 500 VA), controlled by a wired shutter changeover switch (changeover with the same power supply as the motor). Not compatible with radio controlled or pulse controlled shutter motors. It can be installed in the existing shutter box with no need of masonry works. Power supply 110-230 Va.c.

Item	WIRELESS CONTROLS FOR SHUTTER	
<input type="radio"/> LN4027CWI (*)		rolling shutter wireless switch - It allows the control of one or more connected rolling shutter switches. It can be installed in any flush-mounted box without any wiring. The battery can be replaced without removing it from the supporting frame. Integrated LED for low battery indication. Powered by battery 3V type CR2032 (supplied) with an autonomy of 8 years - 1 module
<input type="checkbox"/> N4027CW <input type="checkbox"/> NT4027CW <input type="checkbox"/> L4027CW		rolling shutter wireless switch - It allows the control of one or more connected rolling shutter switches. Surface installation with repositionable stickers (supplied) or onto a flush mounting box. Integrated LED for low battery indication. Powered by battery 3V type CR2032 (supplied) with an autonomy of 8 years - 2 modules

(*) Mechanism provided with front covers in white, tech and and anthracite color finishes

Note: for the use of the connected devices, the gateway, item ...4500C, ...4510C or FG80GT must be installed as part of the system.

If the gateway is connected to the internet through the Wi-Fi network, it will be possible to manage the system from the home using the specific **HOME + CONTROL** App

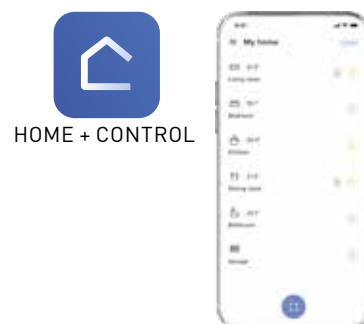

Livinglight

TRADITIONAL ELECTRICAL SYSTEM

Temperature control



N4441



N4451



NT4442

Item		ELECTRONIC THERMOSTATS
<input type="checkbox"/> N4441 <input type="checkbox"/> NT4441 <input type="checkbox"/> L4441		electronic room thermostat - relay output with 1 switching contact 2 A 250 Va.c. - power supply 230 Va.c.
<input type="checkbox"/> N4441FH <input type="checkbox"/> L4441FH <input type="checkbox"/> NT4441FH		as above, with floor probe
<input type="checkbox"/> N4442 <input type="checkbox"/> NT4442 <input type="checkbox"/> L4442		electronic room thermostat with a built-in "summer/winter" changeover switch - relay output with a C-NO 2 A 250 Va.c. contact - power supply 230 Va.c.
<input type="checkbox"/> N4442/127 <input type="checkbox"/> NT4442/127 <input type="checkbox"/> L4442/127		as above - power supply 127V a.c. .

Item		TIMER THERMOSTATS
<input type="checkbox"/> N4451 <input type="checkbox"/> NT4451 <input type="checkbox"/> L4451		flush mounted daily/weekly timer thermostat for heating and cooling systems. Three selectable temperatures during the 24 h period - Auto, Manual, Holiday, Antifreeze Operation. Backlighted display - power supply with battery: 2 x 1.5 V - remote activation using the remote control - possibility of connecting an external probe - output: contact in exchange 5(3) A
ACCESSORIES FOR TIMER THERMOSTATS		
○ F462		GSM Telephone actuator - 4 DIN modules
○ 3457		external probe for L/N/NT4451

Smarter ^{WITH} Netatmo SMART ELECTRICAL SYSTEM

Thermostat



XW8002
XW8002W



XM8002



XG8002

Item **CONNECTED THERMOSTAT**

- XW8002
- XG8002
- XM8002



The Smarter with Netatmo connected thermostat, together with the dedicated HOME+CONTROL APP, is a device which allows you to adjust and monitor the temperature in the rooms precisely and accurately; all the programming and most of the functions are performed simply and intuitively using the APP. Thanks to its Wi-Fi connection, Smarter with Netatmo can be programmed and controlled remotely; it can also display the temperature and humidity measured in the room. The temperature level can be set locally for manual operation and the Boost mode can be activated. The Boost forces the switching on of the system for a limited time (30, 60 or 90 minutes) independent of the measured and programmed temperature.

It's also possible to set a different temperature in each room of the house for the maximum comfort, thanks to its compatibility with Netatmo's smart radiator valves.

Smarter with Netatmo can also be controlled with Google, Amazon Alexa and Apple Home Kit voice assistants.

Features:

- 110 ÷ 230 Va.c., 50/60 Hz power supply;
- 2 W max absorption;
- maximum cable section 1 x 1.5mm²;
- temperature measurement 5 ÷ 40°C;
- temperature set-point 5 ÷ 40°C,
- increase of 0.5°C;
- 1-contact output in switching free of potential 5(2)A.

Types of installation:

- flush mounted, on boxes item 503E or 500 (for item 500 use the wall dowels)
- plasterboard, on boxes 2 module e 3 module

It is available in three colours: white (XW8002), sand (XM8002) and black (XG8002).

- XW8002W features: as .8002.



Installation: on the wall, using screws and dowels suitable for the installation surface (brickwork, plasterboard, tiles etc.). It is only available in white.

DIMENSIONAL DATA

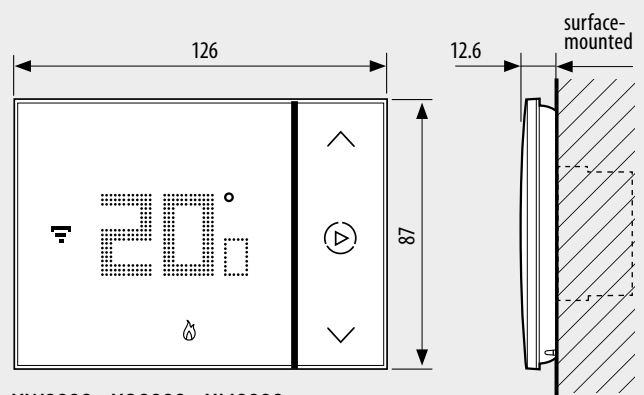

XW8002 - XG8002 - XM8002

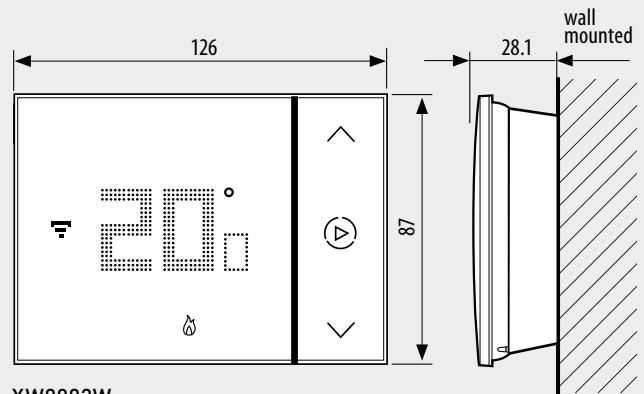

XW8002W



App HOME + CONTROL for management of connected devices



Smarter, the connected thermostat, has been awarded this prestigious international recognition confirming BTicino's capacity in combining technology and design.

Livinglight

TRADITIONAL ELECTRICAL SYSTEM

Socket outlets - Italian standard



Item	ITALIAN STANDARD	
<input type="checkbox"/> N4113 <input type="checkbox"/> NT4113 <input type="checkbox"/> L4113		2 P+E 10 A 250 Va.c. socket - centre distance 19 mm - shielded tulip contacts Ø 4 mm
<input type="checkbox"/> N4180 <input type="checkbox"/> NT4180 <input type="checkbox"/> L4180		2 P+E 16 A 250 Va.c. socket - centre distance 19 mm and 26 mm - shielded tulip contacts - for plugs 2 P and 2 P+E 10 and 16 A Italian standard
<input type="checkbox"/> N4115 <input type="checkbox"/> NT4115 <input type="checkbox"/> L4115		2 P+E 10 A 250 Va.c. safety socket - irreversible for plug item 2200NA or 2200NN
<input type="checkbox"/> 2200NA <input type="checkbox"/> 2200NN		safety plug for N/NT/L4115 socket - colour ivory (NA) or black (NN)

DUPLIX AND TRIPLEX ITALIAN STANDARD		
<input type="checkbox"/> N4180/2 <input type="checkbox"/> NT4180/2 <input type="checkbox"/> L4180/2		duplex socket - two 2 P+E 10 A and 16 A 250 Va.c. parallel sockets - centre distance 19 mm and 26 mm - 2 additional P (phase-neutral) available for shunting - for plugs 2 P and 2 P+E 10 and 16 A Italian standard
<input type="checkbox"/> N4180/3 <input type="checkbox"/> NT4180/3 <input type="checkbox"/> L4180/3		triplex socket - 3 parallel sockets - features as above.

GERMAN AND ITALIAN STANDARDS		
<input type="checkbox"/> N4140 <input type="checkbox"/> NT4140 <input type="checkbox"/> L4140		2 P+E 16 A socket with side contacts and central earthing contact for German standard plugs and 10 A plugs with aligned pins - P30 type - centre distance 19 mm - shielded tulip contacts
<input type="checkbox"/> N4140/16 <input type="checkbox"/> NT4140/16 <input type="checkbox"/> L4140/16		2 P+E 16 A 250 Va.c. socket - centre distance 19 mm and 26 mm in 2-centre configuration - protected tulip contacts; earth side contacts for German standard plugs; suitable for: 2 P and 2 P+E 10/16 A Italian standard plugs, 2 P+E 16 A German standard plugs

Item	FOR SPECIAL USERS	
<input type="checkbox"/> L4180R		2 P+E 16 A 250 Va.c. socket - centre distance 19 mm and 26 mm - shielded tulip contacts - for 2 P and 2 P+E 10 and 16 A Italian standard plugs - colour red
<input type="checkbox"/> L4180V*		as above - colour green
<input type="checkbox"/> L4140/16R		2 P+E 16 A 250 Va.c. socket - centre distance 19 mm and 26 mm in 2-centre configuration - protected tulip contacts; earth side contacts for German standard plugs; suitable for: 2 P and 2 P+E 10/16 A Italian standard plugs, 2 P+E 16 A German standard plugs - colour red
<input type="checkbox"/> L4140X16V*		as above - colour green
<input type="checkbox"/> L4140R		2 P+E 16 A socket with side contacts and central earthing contact for German standard plugs and 10 A plugs with aligned pins - P30 type - centre distance 19 mm - shielded tulip contacts - colour red

* available to order

GERMAN AND ITALIAN STANDARD FLAT SOCKET		
<input type="checkbox"/> N4140/16F <input type="checkbox"/> NT4140/16F <input type="checkbox"/> L4140/16F		When the plug is inserted the socket surface slides inside the casing; it returns to its initial position when the plug is taken out. Socket 2 P+E 16 A 250 Va.c. - 19 and 26 mm centre distance in 2-centre configuration - protected tulip contacts; side earth contact for German standard plugs; suitable for: Italian standard plugs 2P and 2 P+E 10/16 A, and 16A, German standard plugs 2P+E 16 A.

SMART ELECTRICAL SYSTEM

Connected devices for energy management

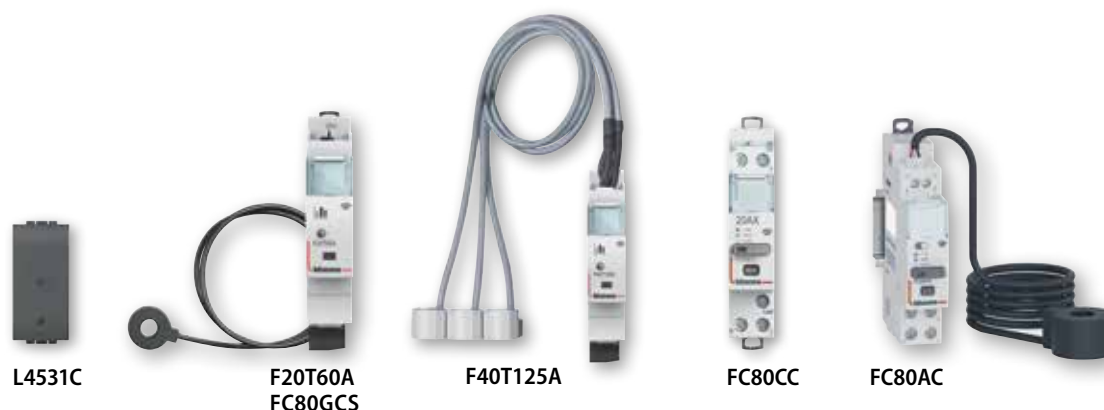

Item	CONNECTED DEVICES FOR ENERGY MANAGEMENT	
<input type="checkbox"/> N4531C <input checked="" type="checkbox"/> NT4531C <input checked="" type="checkbox"/> L4531C		connected socket module - wiring to a power outlet, allows to remotely control appliances and check the consumption (instantaneous, daily, monthly). It is also possible to receive notifications in case of anomalous consumption. The connected socket module is compatible with any device electric and large appliances up to 16 A 3680 W max. (protected against overloads). It is equipped with a LED light lit in blue when it is on. This option can be enabled or disabled in the "Home+Control" app. It can be associated with "wireless light switches". Power supply 110-230 Va.c. - 1 module
○ FC80CC		connected contactor for single-phase and/or three-phase loads with maximum absorption $I_n = 20$ A. With meter for the measurement of the current absorbed by the load. Power supply 110-230 Va.c. - 1 DIN module
○ FC80AC		Smart device for controlling and measuring the consumption of equipment fitted with dry contacts. Rating 12V/30Vdc or 230Vac 2A max. Ideal for controlling and measuring heating appliances, wallboxes and electric vehicle charging stations, ventilation systems, irrigation systems and any other device with a control dry contact. Not suitable for shutter automation. A toroid is supplied, for the measurement of the current absorbed by the load, max 80A. Function management through the Home + Control App, compatible with load management module FC80GCS. 1 DIN module. 100-240V a.c. power supply 50/60 Hz. Requires a Zigbee gateway.
○ F20T60A		Smart DIN meter. It allows to measure the electrical energy consumption of the entire single-phase system of the house (instantaneous, daily, monthly) and of the single electrical power lines. It allows the reception of notifications in case of reaching the maximum power foreseen by the contract to avoid annoying black-outs. A toroid is supplied to measure the input current. Power supply 100-240 Va.c. - 1 DIN module. (Only for single-phase systems).
○ F40T125A		DIN Smart meter like F20T60A but designed for measurement in three-phase systems
Item	CONNECTED DEVICES FOR ENERGY MANAGEMENT	
○ FC80GCS		connected DIN load management module for the monitoring of the consumptions of the whole electric system, the powering or disconnection of the loads, and the setting of scenarios with priority or non-priority loads. When the maximum intended power is reached, the non-priority loads are temporarily disconnected to avoid black-outs. A toroid for the current reading is provided. Power supply 110-230 Va.c. - 1 DIN module

Livinglight ^{WITH} Netatmo SMART ELECTRICAL SYSTEM

Connected sockets

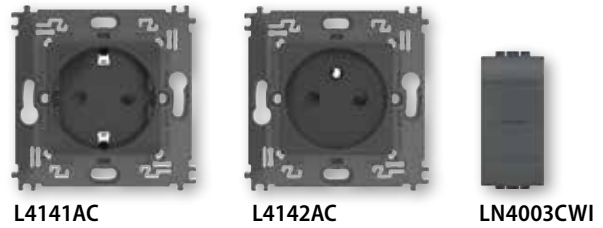

Item		CONNECTED PLUG&PLAY SOCKETS
		Directly connected to an existing socket, it allows remote control of all the connected electrical appliances. It also monitors the instantaneous, daily and monthly consumption. Compatible with all the devices with power up to 16 A 3680 W (with overload protection). It can be associated to wireless light controls. Power supply 110-230 V Va.c.
○ 4141PC		Shuko standard socket
○ 4142PC		French / Belgian standard socket

Item		CONNECTED SOCKETS
<input type="checkbox"/> N4141AC <input type="checkbox"/> NT4141AC <input checked="" type="checkbox"/> L4141AC		2P+E 16 A 250 Va.c. German standard connected socket. It allows remote control of electric devices and also to monitor their consumption (instantaneous, daily, monthly). It is also possible to receive notifications that can be configured. Compatible with all the electric devices with power up to 16 A 3680W (with overload protection). Integrated with a 2-module support, it can be installed instead of an existing socket in a 40 mm deep box. Screw fixing and connection using automatic clamps. It has a blue LED that lights up when the socket is ON and that can be configured by means of the Home + Control APP. It can be associated to one or more wireless light controls. Power supply 110-230 Va.c.
<input type="checkbox"/> N4142AC <input type="checkbox"/> NT4142AC <input checked="" type="checkbox"/> L4142AC		As above French/belgian standard socket

Note: for the use of the connected devices, the gateway, item **...4500C**, **...4510C** or **FG80GT** must be installed as part of the system.

If the gateway is connected to the internet through the Wi-Fi network, it will be possible to manage the system from the home using the specific **HOME + CONTROL** App

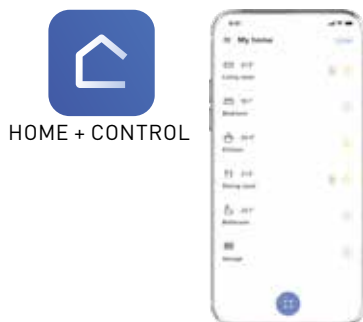

Item		WIRELESS CONTROLS FOR LIGHT AND SOCKETS
○ LN4003CWI (*)		wireless light switch. It allows the ON / OFF and dimming control of one or more connected devices for the lighting control. It can be installed in any flush-mounted box without any wiring. The battery can be replaced without removing it from the supporting frame. Integrated LED for low battery indication. Powered by battery 3V type CR2032 (supplied) with an autonomy of 8 years - 1 module
<input type="checkbox"/> N4003CW <input type="checkbox"/> NT4003CW <input checked="" type="checkbox"/> L4003CW		wireless controls for light, as above. Surface installation with repositionable stickers (supplied) or onto a flush mounting box. - 2 modules.
<input type="checkbox"/> N4003DCW <input type="checkbox"/> NT4003DCW <input checked="" type="checkbox"/> L4003DCW		wireless light switch. It is equipped with two buttons to control two different connected devices for lights. Each single button can be associated with one or more devices. Surface installation with repositionable stickers (supplied) or onto a flush mounting box. Integrated LED for low battery indication. Powered by battery 3V type CR2032 (supplied) with an autonomy of 8 years - 2 modules

Livinglight

TRADITIONAL ELECTRICAL SYSTEM

USB chargers



N4191A NT4191CC NT4191AC L4192C L4191AA

Item		USB CHARGER
<input type="checkbox"/> N4191A <input type="checkbox"/> NT4191A <input type="checkbox"/> L4191A		USB charger with 1 type A port for charging electronic devices up to 15W. - 100-240 V 50-60 Hz DIRECT power supply Output voltage 5V - 1 module
<input type="checkbox"/> N4191AA <input type="checkbox"/> NT4191AA <input type="checkbox"/> L4191AA		USB charger with 2 type A ports for charging single electronic devices up to 15W or simultaneous charging of two devices. - 100-240 V 50-60 Hz DIRECT power supply Output voltage 5V - 1 module
<input type="checkbox"/> N4191CC <input type="checkbox"/> NT4191CC <input type="checkbox"/> L4191CC		USB charger with 2 type C ports for charging single electronic devices up to 15W or simultaneous charging of two devices - 100-240 V 50-60 Hz DIRECT power supply. Output voltage 5V - 1 module
<input type="checkbox"/> N4191AC <input type="checkbox"/> NT4191AC <input type="checkbox"/> L4191AC		USB charger with 2 type A and C ports for charging single electronic devices up to 15W or simultaneous charging of two devices. - 100-240 V 50-60 Hz DIRECT power supply Output voltage 5V - 1 module
<input type="checkbox"/> N4288C2 <input type="checkbox"/> NT4288C2 <input type="checkbox"/> L4288C2		Type C USB charger for quick charge up to 30W. It allows the fast charge of portable devices (PC, tablets, smartphones) based on 3.0 Power Delivery technology and devices not based on 3.0 Power Delivery (tablets, smartphones). Energy efficiency level VI TUV. Standby consumption 0,6W. Output voltage 5 - 9 - 12 - 15 - 20V - 2 modules.
<input type="checkbox"/> N4285C2 <input type="checkbox"/> NT4285C2 <input type="checkbox"/> L4285C2		5 Vdc USB charger for quick charge of one single electronic device (mobile phones, smartphones, tablets or similar) up to 3,000 mA or simultaneous charging of two devices up to 1,500 mA - 110-230 Va.c. DIRECT power supply 50-60 Hz
<input type="checkbox"/> N4192C <input type="checkbox"/> NT4192C <input type="checkbox"/> L4192C		USB charger with 1 type C port for charging single electronic devices up to 20W. It allows the fast charge of portable devices (PC, tablets, smartphones) based on Power Delivery technology. - 100-240 V 50-60 Hz DIRECT power supply Output voltage 5 - 9 -12V - 1 module
<input type="checkbox"/> N4286C2 <input type="checkbox"/> NT4286C2 <input type="checkbox"/> L4286C2		5 Vdc type C USB charger for quick charge of one single electronic device up to 3,000 mA or simultaneous charging of two devices up to 1,500 mA - 110-230 V 50-60 Hz DIRECT power supply, 2 modules
<input type="checkbox"/> N4287C2 <input type="checkbox"/> NT4287C2 <input type="checkbox"/> L4287C2		5 Vdc type A and C USB charger for quick charge of single electronic devices up to 3,000 mA or simultaneous charging of two devices up to 1,500 mA - 110-230 V 50-60 Hz DIRECT power supply - 2 modules

USB CHARGER WITH SOCKET OUTLET

<input type="checkbox"/> N4141USB <input type="checkbox"/> NT4141USB <input type="checkbox"/> L4141USB		German standard electric socket with integrated USB charger. Socket 2 P+E 16 A 250 VA - protected tulip contacts - side earth contact. 5 Vdc type C USB charger for charging electronic devices up to 1,500 mA. Integrated with a 2-module support, it can be installed instead of an existing socket in a 40 mm deep box. Screw fixing and connection using automatic clamps.
--	--	--

Socket outlets

German standards



N4141AN L4141MA L4141MAP

Item		GERMAN STANDARD
<input type="checkbox"/> N4141 <input type="checkbox"/> NT4141 <input type="checkbox"/> L4141		2 P+E 16 A 250 V socket with earth side contacts - shielded tulip contacts
<input type="checkbox"/> L4141RG		as above - colour orange
<input type="checkbox"/> N4141PW <input type="checkbox"/> NT4141PW <input type="checkbox"/> L4141PW		2 P+E 16 A 250 V socket with earth side contacts - shielded tulip contacts - with cover
GERMAN STANDARD (AUTOMATIC CLAMPS)		
<input type="checkbox"/> N4141AN <input type="checkbox"/> NT4141AN <input type="checkbox"/> L4141AN		2 P+E 16 A socket with earth side contacts - automatic clamps - 2 modules
<input type="checkbox"/> N4141MA <input type="checkbox"/> NT4141MA <input type="checkbox"/> L4141MA		2 P+E 16 A socket with earth side contacts - automatic clamps - 2 modules - monobloc
<input type="checkbox"/> N4141MAP <input type="checkbox"/> NT4141MAP <input type="checkbox"/> L4141MAP		2 P+E 16 A socket with earth side contacts - automatic clamps - 2 modules - monobloc with cover
FOR SPECIAL USERS		
<input type="checkbox"/> L4141R		2 P+E 16 A 250 V socket with earth side contacts - shielded tulip contacts - German standard - colour red
<input type="checkbox"/> L4141V		as above - colour green

Livinglight

TRADITIONAL ELECTRICAL SYSTEM

Socket outlets

French standards



NT4143



NT4142



LN4142AN



L4142



L4146



L4141V



NT4145



LN4142MA



L4942N



L4142AN

Item		FRENCH STANDARD
<input type="checkbox"/> N4142AN <input type="checkbox"/> NT4142AN <input type="checkbox"/> L4142AN		2 P+E 16 A 250 Va.c. socket - shielded tulip contacts - automatic clamps
<input type="checkbox"/> N4142 <input type="checkbox"/> NT4142 <input type="checkbox"/> L4142		2 P+E 16 A 250 Va.c. socket - shielded tulip contacts
○ N4142R		socket as above - colour red
<input type="checkbox"/> N4143 <input type="checkbox"/> NT4143 <input type="checkbox"/> L4143		2 P 16 A 250 Va.c. socket - shielded tulip contacts
<input type="checkbox"/> N4144 <input type="checkbox"/> NT4144 <input type="checkbox"/> L4144		2 P+E 16 A socket shielded tulip contacts - with pilot light, with automatic clamps - 2 modules
<input type="checkbox"/> N4145 <input type="checkbox"/> NT4145 <input type="checkbox"/> L4145		2 P+E 16 A 250 Va.c. socket - shielded tulip contacts - with cover
<input type="checkbox"/> N4146 <input type="checkbox"/> NT4146 <input type="checkbox"/> L4146		2 P 10/16 A 250 Va.c. socket with indexing slot

Item		FRENCH STANDARD (AUTOMATIC CLAMPS)
○ LN4142AN		2 P+E 16 A 250 Va.c. socket - neutral finish to be completed with front cover L4942S, N4942S, NT4942S
<input type="checkbox"/> N4942S <input type="checkbox"/> NT4942S <input type="checkbox"/> L4942S		front cover for sockets LN4142AN
○ LN4142MA		2P + E 250 Va.c. socket monobloc - neutral finish to be completed with front cover L4942N, N4942N, NT4942N
<input type="checkbox"/> N4942N <input type="checkbox"/> NT4942N <input type="checkbox"/> L4942N		front cover for sockets LN4142MA
<input type="checkbox"/> N4142AF <input type="checkbox"/> NT4142AF <input type="checkbox"/> L4142AF		Flat socket. When the plug is inserted the socket surface slides inside the casing; it returns to its initial position when the plug is taken out. Socket 2 P+E 10/16 A 250 Va.c. - protected tulip contacts - 2 modules

Socket outlets Euro-American and British standards



N4129S N4150



NT4125 NT4126



L4185



NT4188

Item		EURO-AMERICAN STANDARD
<input type="checkbox"/> N4125S <input type="checkbox"/> NT4125S <input type="checkbox"/> L4125S		2 P 16 A 127/250 Va.c. socket - unshielded tulip contacts - 1 module
<input type="checkbox"/> N4125 <input type="checkbox"/> NT4125 <input type="checkbox"/> L4125		2 P 16 A 127/250 Va.c. socket - Ø 5 mm shielded tulip contacts - 1 module
<input type="checkbox"/> N4126S <input type="checkbox"/> NT4126S <input type="checkbox"/> L4126S		2 P+E 16 A 127/250 Va.c. universal socket - Ø 5 mm unshielded tulip contacts - 2 modules
<input type="checkbox"/> N4126 <input type="checkbox"/> NT4126 <input type="checkbox"/> L4126		2 P+E 16 A 127/250 Va.c. universal duplex socket - Ø 5 mm shielded tulip contacts - 2 modules
<input type="checkbox"/> N4185S <input type="checkbox"/> NT4185S <input type="checkbox"/> L4185S		2 P+E 16 A 127/250 Va.c. universal duplex socket - unshielded tulip contacts - 3 modules
<input type="checkbox"/> N4185 <input type="checkbox"/> NT4185 <input type="checkbox"/> L4185		2 P+E 16 A 127/250 Va.c. universal duplex socket - shielded tulip contacts - 3 modules
BRITISH STANDARD		
<input type="checkbox"/> N4150 <input type="checkbox"/> NT4150 <input type="checkbox"/> L4150		socket outlet 2 modules - 13 AMP (items conform to BS 1363)

Item		AMERICAN STANDARD
<input type="checkbox"/> N4129S <input type="checkbox"/> NT4129S <input type="checkbox"/> L4129S		2 P+E 15 A 127/250 Va.c. socket - unshielded tulip contacts - 1 module
<input type="checkbox"/> N4129 <input type="checkbox"/> NT4129 <input type="checkbox"/> L4129		2 P+E 15 A 127/250 Va.c. socket - shielded tulip contacts - 1 module
<input type="checkbox"/> N4128S <input type="checkbox"/> NT4128S <input type="checkbox"/> L4128S		2 P+E 15 A 127/250 Va.c. socket - unshielded tulip contacts - 2 modules
<input type="checkbox"/> N4188S <input type="checkbox"/> NT4188S <input type="checkbox"/> L4188S		2 P+E 15 A 127/250 Va.c. universal duplex socket - unshielded tulip contacts - 3 modules
<input type="checkbox"/> N4188 <input type="checkbox"/> NT4188 <input type="checkbox"/> L4188		2 P+E 15 A 127/250 Va.c. universal duplex socket - shielded tulip contacts - 3 modules
<input type="checkbox"/> N4188GF6 <input type="checkbox"/> NT4188GF6 <input type="checkbox"/> L4188GF6		2P+E 15 A 127 Va.c. GFCI socket - shielded tulip contacts - 3 modules

NOTE: for other items belonging to the BS offer see the dedicated brochure

BS SOCKET OUTLET ITEM N/NT/L4150 INSTALLATION

WRONG INSTALLATION



4-module cover plate

CORRECT INSTALLATION



7-module cover plate

Livinglight

TRADITIONAL ELECTRICAL SYSTEM

Socket outlets - Different international standards



N4132



NT4132



NT4183



L4139



L4122ET



L4164/12

Item		AUSTRALIAN STANDARD
<input type="checkbox"/> N4132 <input type="checkbox"/> NT4132 <input type="checkbox"/> L4132		2 P+E 10 A 250 Va.c. socket - safety socket, shuttered and auto switched - 2 modules
<input type="checkbox"/> N4133 <input type="checkbox"/> NT4133 <input type="checkbox"/> L4133		2 P+E 15 A 250 Va.c. socket - safety socket, shuttered and auto switched - 2 modules
BRAZILIAN STANDARD		
<input type="checkbox"/> N4165S <input type="checkbox"/> L4165S		10 A socket with unshielded tulip contacts - 1 module
<input type="checkbox"/> N4166S <input type="checkbox"/> L4166S		20 A socket with unshielded tulip contacts - 1 module
SHAVER SOCKETS		
<input type="checkbox"/> N4177* <input type="checkbox"/> NT4177* <input type="checkbox"/> L4177*		shaver socket with insulating transformer - input voltage 230V a.c. 50/60Hz - output voltage 115/230V a.c. 20VA - 3 modules
<input type="checkbox"/> N4177/127* <input type="checkbox"/> L4177/127*		as above - input voltage 127V a.c.
*Note: when installed with Livinglight AIR, the use of the box extension is necessary, in order to make easy the wiring		
EGYPTIAN STANDARD		
<input type="checkbox"/> N4122ET <input type="checkbox"/> NT4122ET <input type="checkbox"/> L4122ET		2 P 10 A 250 Va.c. socket - contact tubes Ø 4 - 4.8 mm - centre line of holes 19 mm - 1 module
SWISS STANDARD		
<input type="checkbox"/> N4164/13 <input type="checkbox"/> NT4164/13 <input type="checkbox"/> L4164/13		2 P+E 10 A 250 Va.c. socket - 2 modules
ISRAELI STANDARD		
<input type="checkbox"/> N4183 <input type="checkbox"/> NT4183 <input type="checkbox"/> L4183		2 P+E 10/16 A 250 Va.c. socket - 2 modules
MULTISTANDARD		
<input type="checkbox"/> N4139 <input type="checkbox"/> NT4139 <input type="checkbox"/> L4139		2 P+E 5/6/10/13 A 250 Va.c. and 127 Va.c. socket - multistandard - 2 modules

RJ connectors



N4261AT5



NT4262C5E



L4279C5E

N4261AT6 N4262C6 L4279C6



L4262C6S

Item		RJ45 CONNECTORS	
		RJ 45 data transmission/telephone connectors. Specially designed for data and telephone transmission. These connectors are widely used for computer networks with a 4-pair cable.	
		Category	Connection type
<input type="checkbox"/> N4279C5E <input type="checkbox"/> NT4279C5E <input type="checkbox"/> L4279C5E		5E UTP	TOOLLESS IDC
<input type="checkbox"/> N4279C6 <input type="checkbox"/> NT4279C6 <input type="checkbox"/> L4279C6		6 UTP	TOOLLESS IDC
<input type="checkbox"/> N4279C6S <input type="checkbox"/> NT4279C6S <input type="checkbox"/> L4279C6S		6 STP	TOOLLESS IDC
<input type="checkbox"/> N4279C6A <input type="checkbox"/> NT4279C6A <input type="checkbox"/> L4279C6A		6A STP	TOOLLESS IDC
<input type="checkbox"/> N4262C5E <input type="checkbox"/> NT4262C5E <input type="checkbox"/> L4262C5E		5E UTP	110 IDC
<input type="checkbox"/> N4262C6 <input type="checkbox"/> NT4262C6 <input type="checkbox"/> L4262C6		6 UTP	110 IDC
<input type="checkbox"/> N4262C6S <input type="checkbox"/> NT4262C6S <input type="checkbox"/> L4262C6S		6 STP	110 IDC
<input type="checkbox"/> N4261AT5 <input type="checkbox"/> NT4261AT5 <input type="checkbox"/> L4261AT5		5E UTP	110 IDC
<input type="checkbox"/> N4261AT6 <input type="checkbox"/> NT4261AT6 <input type="checkbox"/> L4261AT6		6 UTP	110 IDC

TV - FM - SAT sockets



L4214DN



NT4214M2DN



NT4210M2DN



S2133



L4202DN



NT4202M2DN



NT4202P14N



L4202P10N



N4202FN

Item	STAR TV/SAT DEMIXED SOCKET
<input type="checkbox"/> N4214DN <input checked="" type="checkbox"/> L4214DN <input checked="" type="checkbox"/> NT4214DN	<p>Star demixed coaxial socket for single-user aerial systems, also remote powered and shunting centralised, and for single-user /shunting centralised satellite systems with current and signal transfer for channels selection; Ø 9.5 mm male TV connector - type F SAT connector - 1 module</p>
<input type="checkbox"/> N4214M2DN <input checked="" type="checkbox"/> L4214M2DN <input checked="" type="checkbox"/> NT4214M2DN	<p>as above - 2 modules</p>
<input type="checkbox"/> N4217M2DN <input checked="" type="checkbox"/> L4217M2DN <input checked="" type="checkbox"/> NT4217M2DN	<p>Class A shielded direct (single) coaxial base, compatible with 4G LTE. Bases adapted to the reception of DTT, satellite and cable television. Compatible with Ultra High Definition television. Coaxial cable recommended 17 VATC. Possibility to view the connection through the mechanism. Complies with EN-50083 and the Directive European EN-50083-2. IEC Ø9.5 mm male TV and R connectors and IEC Ø 9.5 mm female SAT connector. Supported frequency band: TV: 5-68/120-862 MHz, R: 87.5-108MHz, SAT: 950-2.400 MHz – attenuation 1.5 dB – 2 modules.</p>

NOTE: for an optimum use of the product, all the outputs must be used

Item	STAR TV/R/SAT DEMIXED SOCKET
<input type="checkbox"/> N4210M2DN <input checked="" type="checkbox"/> L4210M2DN <input checked="" type="checkbox"/> NT4210M2DN	<p>Star demixed coaxial socket for single-user aerial systems, also remote powered and shunting centralised, and for single-user /shunting centralised satellite systems with current and signal transfer for channels selection, and for radio systems; Ø 9.5 mm male TV connector - type F SAT connector and female radio Ø 9,5 mm - 2 modules</p>

NOTE: for an optimum use of the product, all the outputs must be used

Item	TV-RD SOCKET FOR CABLE OPERATOR
<input type="checkbox"/> L4211M2CN <input checked="" type="checkbox"/> N4211M2CN <input checked="" type="checkbox"/> NT4211M2CN	<p>Double coaxial shunted socket for TV and FM-LMC reception - Ø 9.5mm - Belgium (Telenet operator) - 2 modules</p>

PLUG

○ S2133	<p>Plugs, mobile TV jacks and terminal resistance Mobile TV plug and jack - Ø 9.5 mm - white - for TV + SAT jacks and N/NT4206D</p>
○ 75RTN	<p>Terminal resistance for line closing 75Ω impedance in installations with cascade connection - to be added to the last pass-through jack</p>

Item	STAR TV SOCKET
<input type="checkbox"/> N4202DN <input checked="" type="checkbox"/> L4202DN <input checked="" type="checkbox"/> NT4202DN	<p>Star coaxial socket for single-user aerial systems, also remote powered and centralised, and single-user / centralised satellite systems with current and signal transfer for channels selection; shielded connection clamps with captive screws - Ø 9.5 mm; male connector - supplied in package with common mechanism and front covers in different aesthetic finishes - 1 module</p>
<input type="checkbox"/> N4202M2DN <input checked="" type="checkbox"/> L4202M2DN <input checked="" type="checkbox"/> NT4202M2DN	<p>as above - 2 modules</p>

Item	PASSTHROUGH TV SOCKET
<input type="checkbox"/> N4202P14N <input checked="" type="checkbox"/> L4202P14N <input checked="" type="checkbox"/> NT4202P14N	<p>Passthrough coaxial socket, -14dB attenuation, for centralised TV systems, also remote powered, and centralised satellite systems with current and signal transfer for channels selection - shielded connection clamps with captive screws - Ø 9.5 mm; male connector - 1 module</p>
<input type="checkbox"/> N4217M2P14N <input checked="" type="checkbox"/> L4217M2P14N <input checked="" type="checkbox"/> NT4217M2P14N	<p>Intermediate coaxial base as the item N4217M2DN, 4217M2DN and T4217M2DN - Attenuation: 14 dB - 2 modules</p>
<input type="checkbox"/> N4217M2P10N <input checked="" type="checkbox"/> L4217M2P10N <input checked="" type="checkbox"/> NT4217M2P10N	<p>Intermediate coaxial base as the item N4217M2DN, 4217M2DN and T4217M2DN with final adapter of built-in 75 Ω impedance - Attenuation: 10 dB - 2 modules</p>

Item	TERMINAL TV SOCKET
<input type="checkbox"/> N4202P10N <input checked="" type="checkbox"/> L4202P10N <input checked="" type="checkbox"/> NT4202P10N	<p>Terminal coaxial socket, -10dB attenuation, for centralised TV systems, also remote powered, and centralised satellite systems with current and signal transfer for channels selection; shielded connection clamps with captive screws - Ø 9,5 mm - male connector - incorporated impedance final adapter 75 Ω - 1 module</p>

Item	TYPE-F SAT SOCKET
<input type="checkbox"/> N4202FN <input checked="" type="checkbox"/> L4202FN <input checked="" type="checkbox"/> NT4202FN	<p>Type-F coaxial socket - impedance 75 ohm - screw hook - 1 module</p>

NOTE: the photographs of the Axolute items represent the product code indicated to which one of the three front cover plates (white, tech or anthracite) available in the package is already fitted.

Livinglight

TRADITIONAL ELECTRICAL SYSTEM

Telephone connectors, data and special sockets



N4258/11N



N4237



NT4268LC



NT4285



L4269R



L4284



N4294

Item	RJ11 - RJ12 TELEPHONE CONNECTORS	
	These connectors have been designed for meeting the requirements of telephone connections.	
	Jack type	Connection type
<input type="checkbox"/> N4258/11N <input type="checkbox"/> NT4258/11N <input type="checkbox"/> L4258/11N	RJ11	K10
(1) Connection type 110		

TELEPHONE SOCKETS		
<input type="checkbox"/> N4237 <input type="checkbox"/> NT4237 <input type="checkbox"/> L4237		telephone socket - Belgian standard - 1 module
<input type="checkbox"/> N4238 <input type="checkbox"/> NT4238 <input type="checkbox"/> L4238		telephone socket - Israeli standard without shutter - 1 module
<input type="checkbox"/> N4238M <input type="checkbox"/> NT4238M		master telephone socket UK standard - 1 module
<input type="checkbox"/> N4238S <input type="checkbox"/> NT4238S		secondary telephone socket UK standard - 1 module

CONNECTORS FOR OPTICAL FIBER CONNECTIONS		
<input type="checkbox"/> N4268SC <input type="checkbox"/> NT4268SC <input type="checkbox"/> L4268SC		coupling connector for optical fiber - SC cable socket - duplex - 1 module
<input type="checkbox"/> N4268LC <input type="checkbox"/> NT4268LC <input type="checkbox"/> L4268LC		connector for fiber - optic cable sealing and type LC - duplex - 1 module

Item	AUDIO VIDEO CONNECTORS	
<input type="checkbox"/> N4269R <input type="checkbox"/> NT4269R <input type="checkbox"/> L4269R		double RCA connector – red and yellow collars – terminations to be welded - 1 module
<input type="checkbox"/> N4294 <input type="checkbox"/> NT4294 <input type="checkbox"/> L4294		connector for loudspeakers - 1 module
<input type="checkbox"/> N4280 <input type="checkbox"/> NT4280 <input type="checkbox"/> L4280		connector - jack 3.5 - 1 module
<input type="checkbox"/> N4281 <input type="checkbox"/> NT4281 <input type="checkbox"/> L4281		connector - RCA x 2 - 1 module
<input type="checkbox"/> N4282 <input type="checkbox"/> NT4282 <input type="checkbox"/> L4282		connector - HD15 - 2 modules
<input type="checkbox"/> N4283 <input type="checkbox"/> NT4283 <input type="checkbox"/> L4283		RCA x 3 connector - 2 modules
<input type="checkbox"/> N4284 <input type="checkbox"/> NT4284 <input type="checkbox"/> L4284		pre-connected HDMI 2.0 connector - 2 modules
DATA CONNECTOR		
<input type="checkbox"/> N4285 <input type="checkbox"/> NT4285 <input type="checkbox"/> L4285		USB connector - 1 module
SPECIAL CONNECTORS		
<input type="checkbox"/> N4291 <input type="checkbox"/> NT4291 <input type="checkbox"/> L4291		2P mignon socket - tulip contacts Ø mm 3 - centre distance 13 mm - for auxiliary circuits and similar 6 A 24 V SELV - clamp connection - 1 module

Audible signalling devices



Item		BELLS
<input type="checkbox"/> N4351/12 <input type="checkbox"/> NT4351/12 <input checked="" type="checkbox"/> L4351/12		bronze bell 12 Va.c. - 5 VA - 80 dB - 1 module
<input type="checkbox"/> N4351/230 <input type="checkbox"/> NT4351/230 <input checked="" type="checkbox"/> L4351/230		bronze bell 230 Va.c. - 8 VA - 80 dB - 50 and 60 Hz - 1 module
<input type="checkbox"/> N4351/127 <input type="checkbox"/> NT4351/127 <input checked="" type="checkbox"/> L4351/127		bronze bell 127 Va.c. - 8 VA - 80 dB - 1 module
<input type="checkbox"/> N4355/12 <input type="checkbox"/> NT4355/12 <input checked="" type="checkbox"/> L4355/12		electronic bell - 3 different sounds - with front volume adjustment - 12 Va.c./d.c. - 2 modules
BUZZERS		
<input type="checkbox"/> N4356/12 <input type="checkbox"/> NT4356/12 <input checked="" type="checkbox"/> L4356/12		buzzer 12 Va.c. - 5 VA - 74 dB - 1 module
<input type="checkbox"/> N4356/230 <input type="checkbox"/> NT4356/230 <input checked="" type="checkbox"/> L4356/230		buzzer 230 Va.c. - 8 VA - 75 dB - 50 and 60 Hz - 1 module
<input type="checkbox"/> N4356/127 <input type="checkbox"/> NT4356/127 <input checked="" type="checkbox"/> L4356/127		buzzer 127 Va.c. - 8 VA - 75 dB - 1 module

Luminous signalling devices



Item		PILOT LIGHTS
<input type="checkbox"/> N4371T <input type="checkbox"/> NT4371T <input checked="" type="checkbox"/> L4371T		lampholder with transparent diffuser - for LED items LN4742V12T, LN4742V127T and LN4742V230T - 1 module
<input type="checkbox"/> N4371R <input type="checkbox"/> NT4371R <input checked="" type="checkbox"/> L4371R		lampholder with red diffuser - for LED items LN4742V12T, LN4742V127T and LN4742V230T - 1 module
<input type="checkbox"/> N4371V <input type="checkbox"/> NT4371V <input checked="" type="checkbox"/> L4371V		lampholder with green diffuser - for LED items LN4742V12T, LN4742V127T and LN4742V230T - 1 module
<input type="checkbox"/> N4372AV <input type="checkbox"/> NT4372AV <input checked="" type="checkbox"/> L4372AV		double lampholder with 2 diffusers: 1 orange + 1 green - for 2 LED items LN4742V12T, LN4742V127T and LN4742V230T - 1 module
OFF-DOOR LIGHT UNITS (WITH LAMP)		
Note: for all models we recommend a mounting height between 160 and 205 cm (wall protrusion 52 mm)		
<input checked="" type="checkbox"/> L4385/12R <input checked="" type="checkbox"/> L4385/12V <input checked="" type="checkbox"/> L4385/12B		power supply 12 V - red (R), green (V), white (B) - 1 module
<input checked="" type="checkbox"/> L4385/24R <input checked="" type="checkbox"/> L4385/24V <input checked="" type="checkbox"/> L4385/24B		power supply 24 V - red (R), green (V), white (B) - 1 module
<input checked="" type="checkbox"/> L4385/230R <input checked="" type="checkbox"/> L4385/230V <input checked="" type="checkbox"/> L4385/230B		power supply 230 V - red (R), green (V), white (B) - 1 module
<input type="checkbox"/> L4745/12		spare lamp E10 12 V - 2 W
<input type="checkbox"/> L4745/24		spare lamp E10 24 V - 5 W
<input type="checkbox"/> L4745/230		spare lamp E10 230 V - 5 W
SIGNALLING LAMP		
<input type="checkbox"/> L4374V12V24		signalling lamp with white light LED - 12/24 Va.c. - 2 modules
<input type="checkbox"/> L4374/230		signalling lamp with white light LED - 230 Va.c. - 2 modules

Livinglight

TRADITIONAL ELECTRICAL SYSTEM

Lighting devices and emergency lamps



LN4380N



LN4361



L4382/230



NT4362

Item

REMOVABLE LAMP

○ LN4380N



Pull-out and rechargeable torch with automatic switching on device. - It lights up automatically when there is a power cut - push&pull pull-out system complete with recharge base - white light LED with high luminous efficiency - ON/OFF switch and SPOT pushbutton to increase the brightness when necessary - interchangeable Ni-MH batteries without "memory" effect - 2 hour life - low consumption in stand-by 0.4 W - 230 Va.c. power supply - 2 modules. Supplied in box with base and front cover plate in opaline finish, neutral.

○ 4380NB



spare batteries for removable torch

STEP MARKER LAMPS

○ L4382V12V24



Step marker lamps with white light LEDs - 12 - 24 Vac - on-off switch- 0.6 W at 12 Va.c. - 0.8 W at 24 Va.c.

○ L4382/230



Step marker lamps with white light LEDs - 230 Vac - on-off switch - 0.5 W

Items conform to BS EN 62 094-1

ROTATING LAMP 360°

○ LN4360



It is installed above a work place (kitchen, bedroom, desk ...) - Can be oriented by 360° for best lighting of the zone required - It can be controlled by a standard switch or an electronic switch without neutral, by a dimmer or an automatic switch with neutral - LED lamps - Consumption 2.8W - Luminous flux 70 lumen - life: approx. 50.000 hours - 2 modules - Supplied with neutral base and front cover plates in white, tech, anthracite colours

DIRECTIONAL STEPMARKER

○ LN4361



Allows you to create directional and decorative lighting. We recommend installation at 30 cm from the floor - It can be controlled by a standard switch or an electronic switch without neutral, by a dimmer or an automatic switch with neutral - LED lamp - Consumption 2.2W - Luminous flux 70 lumen - life: approx. 50.000 hours - 2 modules. Supplied with neutral base and front cover plates in white, tech, anthracite colours

Item

DIMMABLE READING LAMP

□ N4362
■ NT4362
■ L4362

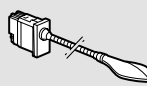

It is installed at the bedhead giving directional lighting. It has a flexible arm so that the lighting arm can be directed. The brightness can be dimmed by pressing the integrated ON/OFF control for a long time. It can also be connected to a remote control and, if necessary, the integrated control can be disabled with a 30 sec. press. - LED lamp - 3W consumption - Luminous flux 110 lumen (equivalent to 15 W incandescence) - Life 40,000 hours - 1 module (flush-mounted). Cover supplied with device.

Emergency lamps



L4384/1



LN4381



L4784/1 - L4784/3



L4386/1

EMERGENCY LIGHTS

○ L4384/1



emergency light with automatic activation in case of power cut – voltage present notification LED - local disabling pushbutton - possibility of remote exclusion through a switch - rechargeable and replaceable nickel-cadmium battery - 1 h life - power supply 230 Va.c. - lamp power 1 W - 4 modules

○ L4386/1

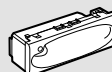

emergency light as above - 1 h life - lamp power 1.3 W - 6 modules

○ LN4381



LED safety lamp with automatic operation when there is a power cut. 230 Va.c. 50/60 Hz – power consumption 2.5 VA (0.1 W) – rechargeable non-replaceable NiMH 3.6 V 140 mAh battery – complete charge in 48 hours - life 2 hours - maximum cable section 1 x 1.5 mm² - light intensity 2400 mcd - angle of emission 120° - not pull-out - 1 module

*NOTE: If installed with AIR plates, it is necessary to use Box extension, to make easy the wiring

SPARE BATTERY

○ L4784/1



spare battery for Item L4384/1

○ L4786/1



spare battery for Item L4386/1

Electrical safety devices



Item		AUTOMATIC THERMAL MAGNETIC CIRCUIT BREAKERS
<input type="checkbox"/> N4301/6 <input type="checkbox"/> NT4301/6 <input type="checkbox"/> L4301/6		two-pole automatic thermal magnetic circuit breakers with a 6 A 230 Va.c. protected pole - indicator of open/closed contacts - breaking capacity 1500 A 230 Va.c.
<input type="checkbox"/> N4301/10 <input type="checkbox"/> NT4301/10 <input type="checkbox"/> L4301/10		circuit breakers as above 10 A - breaking capacity 3000 A 230 Va.c.
<input type="checkbox"/> N4301/16 <input type="checkbox"/> NT4301/16 <input type="checkbox"/> L4301/16		circuit breakers as above 16 A - breaking capacity 3000 A 230 Va.c.
SALVAVITA		
<input type="checkbox"/> N4305/6 <input type="checkbox"/> NT4305/6 <input type="checkbox"/> L4305/6		Salvavita - two-pole automatic thermal magnetic circuit breakers with a protected pole $I_{\Delta n}$ 10 mA - 6 A 230 Va.c. - indicator of open/closed contacts - test pushbutton- breaking capacity 1500 A 230 Va.c. - 2 modules
<input type="checkbox"/> N4305/10 <input type="checkbox"/> NT4305/10 <input type="checkbox"/> L4305/10		Salvavita as above - 10 A - breaking capacity 3000 A 230 Va.c.
<input type="checkbox"/> N4305/16 <input type="checkbox"/> NT4305/16 <input type="checkbox"/> L4305/16		Salvavita as above - 16 A - breaking capacity 3000 A 230 Va.c.
INTERLOCKED SOCKETS		
<input type="checkbox"/> N4311/10 <input type="checkbox"/> NT4311/10 <input type="checkbox"/> L4311/10		2 P+E socket with shielded tulip contacts 10 A - 230 Va.c. - protection index 2.1 - interlocked with two-pole automatic thermal magnetic circuit breaker- 10 A - breaking capacity 3000 A with 1 protected pole - 2 mod.
<input type="checkbox"/> N4311/16 <input type="checkbox"/> NT4311/16 <input type="checkbox"/> L4311/16		interlocked socket as above 16 A - 230 Va.c.
FUSE CARRIERS		
<input type="checkbox"/> N4321 <input type="checkbox"/> NT4321 <input type="checkbox"/> L4321		fuse carrier for fuses 5x20 and 6.3x 32 max 13A - 240 Va.c.
<input type="checkbox"/> N4322 <input type="checkbox"/> NT4322 <input type="checkbox"/> L4322		fuse carrier for fuses 8,5 x 31,5 mm - max 16A type T/...
SURGE PROTECTIVE DEVICES		
<input type="checkbox"/> N4536 <input type="checkbox"/> NT4536 <input type="checkbox"/> L4536		1 P surge protective devices to be combined with the users mains socket - rated discharge voltage $I_n=1$ kA - max. current $I_{max}=2$ kA - max. protection voltage $U_p=1$ kV - rated voltage $U_n=110-230$ Va.c. - max. permanent voltage $U_c=250$ Va.c.

Blank plates and fuses



Item		BLANK PLATES
<input type="checkbox"/> N4950 <input type="checkbox"/> NT4950 <input type="checkbox"/> L4950		blank plate - 1 module
<input type="checkbox"/> N4951 <input type="checkbox"/> NT4951 <input type="checkbox"/> L4951		blank plate with knockout - 2 modules
<input type="checkbox"/> N4952 <input type="checkbox"/> L4952		blank plate with clamp - 1 module
<input type="checkbox"/> N4953 <input type="checkbox"/> NT4953 <input type="checkbox"/> L4953		blank plate with output $\varnothing 9$ mm - 1 module
<input type="checkbox"/> N4954 <input type="checkbox"/> NT4954 <input type="checkbox"/> L4954		blank plate with output $\varnothing 9$ mm - with clamp - 2 modules
FLEX OUTLETS		
Items conform to BS 5733		
<input type="checkbox"/> N4955/20 <input type="checkbox"/> NT4955/20		- 20 A flex outlet frontplate unfused
<input type="checkbox"/> N4955/45 <input type="checkbox"/> NT4955/45		- 45 A flex outlet frontplate unfused
SCREW COVERING SEALS		
<input type="checkbox"/> N4750		screw covering seals for device-holder supports item LN4719, LN4703
CARTRIDGE FUSES		
<input type="checkbox"/> T/...		4-6-10-16-20 A - 400 V - breaking capacity 50 KA ceramic body - $\varnothing 8.5 \times 31.5$ mm
<input type="checkbox"/> T1/...		4-6-10-16-20-25 A - 400 V - breaking capacity 50 KA ceramic body - $\varnothing 9 \times 36$ mm
<input type="checkbox"/> T0/...		2-4-6-10-16A - 250V - breaking capacity 1.5KA ceramic body for home series devices - $\varnothing 6 \times 28$ mm

To be used with N4322, NT4322, L4322 fuse carrier
NOTE: specify in the order the desired rated current

Livinglight

TRADITIONAL ELECTRICAL SYSTEM

Hotel offer range

This page lists the devices specifically intended for hotel room services. The BTicino hotel room offer range, and in more general terms for the hotel sector, includes however many more devices that are also used in other sectors, and are therefore listed in various sections throughout this catalogue. Some of them are, for example:

- comfort devices = light, curtain, and scenario controls with dedicated symbols. Also, thermostats, and temperature probes with knobs
 - audio and video devices = connectors for every need, and sound signalling devices
 - safety devices = step lights, and emergency lamps



LN4549



N4547



L4177



N4033

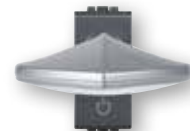

L4362



NT4915DD



NT4915MR





N4373H







L48028HN







L4285C2

Item		BADGE-HOLDER POCKET
○ LN4549		key card switch for the power supply inside the hotel room - slot light with built-in lamp - 30 second switch-off delay - power supply 230 Va.c. - 2 modules - to be completed with front cover in the desired look
○ LN4548		key card switch for the power supply inside the hotel room with RFID technology recognition - slot light with built-in lamp - 30 second switch off delay - power supply 230 Va.c. - 2 modules - to be completed with front cover in the desired look

		FRONT COVERS FOR BADGE-HOLDER POCKETS
<input type="checkbox"/> N4547		Front cover for traditional badge-holder pocket or MyHOME - SCS - 2 modules
<input type="checkbox"/> NT4547		
<input type="checkbox"/> L4547		
<input type="checkbox"/> N4551		Front cover for traditional badge-holder pocket or MyHOME - SCS - 3 modules
<input type="checkbox"/> NT4551		
<input type="checkbox"/> L4551		

		KEY COVER WITH SYMBOLS
<input type="checkbox"/> N4915DD		do not disturb
<input type="checkbox"/> NT4915DD		
<input type="checkbox"/> L4915DD		
<input type="checkbox"/> N4915MR		rearrange the room
<input type="checkbox"/> NT4915MR		
<input type="checkbox"/> L4915MR		
<input type="checkbox"/> N4915M2DD		do not disturb - 2 modules
<input type="checkbox"/> NT4915M2DD		
<input type="checkbox"/> L4915M2DD		

		MAKE UP THE ROOM - DO NOT DISTURB
<input type="checkbox"/> N4373H		off-door lampholder with double optical signalling: DO NOT DISTURB - MAKE UP ROOM - 230V built in LEDs
<input type="checkbox"/> NT4373H		
<input type="checkbox"/> L4373H		
<input type="checkbox"/> N4028HN		changeover switch 1P 16A - 250V a.c. double pushbutton 1-0-2 for Hotel installation - room condition indication: "PLEASE DO NOT DISTURB" and "PLEASE MAKE UP THE ROOM". To use with pilot light item. Items conform to BS EN 60 669-1
<input type="checkbox"/> NT4028HN		
<input type="checkbox"/> L4028HN		



Item		KEY COVERS THAT CAN BE CUSTOMISED WITH DIFFUSERS
<input type="checkbox"/> N4915TN		keycover for rocker controls, customizable with lightable diffusers
<input type="checkbox"/> NT4915TN		
<input type="checkbox"/> L4915TN		
<input type="checkbox"/> N4915SETBL		kit of 50 diffusers bed light symbol
<input type="checkbox"/> NT4915SETBL		
<input type="checkbox"/> L4915SETBL		

		SHAVER SOCKETS
<input type="checkbox"/> N4177*		shaver socket with insulation transformer - input voltage 230 Vac @ 50/60 Hz - output voltage 115/230 Vac 20 VA
<input type="checkbox"/> NT4177*		
<input type="checkbox"/> L4177*		

*Note: when installed with Livinglight AIR, the use of the box extension is necessary, in order to make easy the wiring

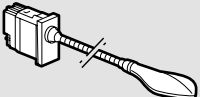
		CORD PUSHBUTTON
<input type="checkbox"/> N4033		cord pushbutton 1 P NO 10 A for bathroom alarm
<input type="checkbox"/> NT4033		
<input type="checkbox"/> L4033		

		DIMMER READING LAMP
<input type="checkbox"/> N4362		It is installed at the bedhead giving directional lighting. It has a flexible arm so that the lighting arm can be directed. The brightness can be dimmed by pressing the integrated ON/OFF control for a long time. It can also be connected to a remote control and, if necessary, the integrated control can be disabled with a 30 sec. press. - LED lamp - 3W consumption - Luminous flux 110 lumen (equivalent to 15 W incandescence) - Life 40,000 hours - 1 module (flush-mounted).
<input type="checkbox"/> NT4362		
<input type="checkbox"/> L4362		

		USB CHARGERS
<input type="checkbox"/> N4191A		USB charger with 1 type A port for charging electronic devices up to 15W. - 100-240 V 50-60 Hz DIRECT power supply Output voltage 5V - 1 module
<input type="checkbox"/> NT4191A		
<input type="checkbox"/> L4191A		
<input type="checkbox"/> N4191AA		USB charger with 2 type A ports for charging single electronic devices up to 15W or simultaneous charging of two devices. - 100-240 V 50-60 Hz DIRECT power supply Output voltage 5V - 1 module
<input type="checkbox"/> NT4191AA		
<input type="checkbox"/> L4191AA		

LEDs for controls and pilot lights



LN4742V12T



LN4742V230

Item	LEDs FOR ROCKER CONTROLS
○ LN4742V230B	LED for rocker controls 230 V - blue
○ LN4742V230	LED for rocker controls 230 V - amber
○ LN4742V127	LED for rocker controls 127 V - amber
○ LN4742V12	LED for rocker controls 12 /24 V - amber
○ LN4742V230V	LED for rocker controls 230 V - green
○ LN4742V127V	LED for rocker controls 127 V - green
○ LN4742V12V	LED for rocker controls 12 /24 V - green
○ LN4742V230T	white LED for pilot lights and BS 230 V devices
○ LN4742V127T	white LED for pilot lights and BS 127 V devices
○ LN4742V12T	white LED for pilot lights and BS 12 /24 V devices

	LEDs FOR AXIAL CONTROLS
○ H4743/230B	LED for axial controls 230 V - blue
○ H4743/12B	LED for axial controls 12 /24 V - blue
○ LN4743/230T	LED for axial controls 230 V - white
○ LN4743/230V	LED for axial controls 230 V - green
○ LN4743/12T	LED for axial controls 12 /24 V - white
○ LN4743/230A	LED for axial controls 230 V - amber
○ LN4743/127A	LED for axial controls 127 V - amber
○ LN4743/12V	LED for axial controls 12 /24 V - green
○ LN4743/127T	LED for axial controls 127 V - white
○ LN4743/127V	LED for axial controls 127 V - green
○ LN4743/12A	LED for axial controls 12 /24 V - amber

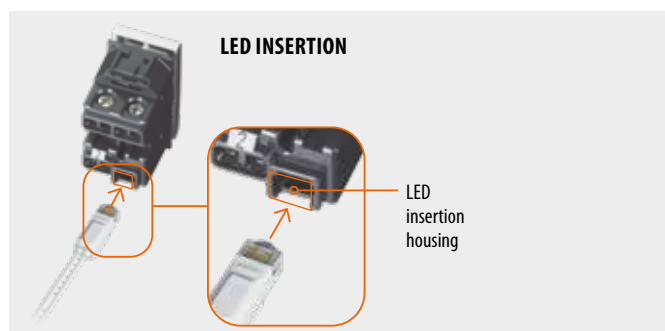

LED SELECTION TABLE FOR DEVICE LIGHTING

Lightable devices	LEDs for lighting
Rocker control devices	
Screw clamps	
1 module	2 modules
L4001/0	
L4003/0	
LN4004	
L4005/0	
N/NT/L4001N	N/NT/L4001M2N
N/NT/L4003N	N/NT/L4003M2N
N/NT/L4004N	N/NT/L4004M2N
N/NT/L4005N	N/NT/L4005M2N
N/NT/L4002N	N/NT/L4002M2N
N/NT/L4044N	N/NT/L4044M2N
	LN4742V12 (12/24 V)
	LN4742V127 (127 V)
	LN4742V230 (230 V)
	LN4742V12V (12/24 V)
	LN4742V127V (127 V)
	LN4742V230V (230 V)
Automatic clamps	
1 module	2 modules
LN4001A	
LN4003A	
LN4005A	
N/NT/L4001A	N/NT/L4001M2A
N/NT/L4003A	N/NT/L4003M2A
N/NT/L4005A	N/NT/L4005M2A
	LN4743/230T (230 V)
	LN4743/230V (230 V)
	LN4743/12T (12 V)
	LN4743/230A (230 V)
	LN4743/127A (127 V)
	LN4743/12V (12 V)
	LN4743/127T (127 V)
	LN4743/127V (127 V)
	LN4743/12A (12 V)
Axial control devices	
1 module	2 modules
N/NT/L4051A	N/NT/L4051M2A
N/NT/L4053A	N/NT/L4053M2A
N/NT/L4054A	N/NT/L4054M2A
N/NT/L4055A	N/NT/L4055M2A
	LN4743/230T (230 V)
	LN4743/230V (230 V)
	LN4743/12T (12 V)
	LN4743/230A (230 V)
	LN4743/127A (127 V)
	LN4743/12V (12 V)
	LN4743/127T (127 V)
	LN4743/127V (127 V)
	LN4743/12A (12 V)
Pushbuttons with pilot light lampholder	
1 module	
N/NT/L4038R	LN4742V12T (12/24 V)
N/NT/L4038V	LN4742V127T (127 V)
LN4040	LN4742V230T (230 V)
Pilot light lampholder	
1 module	
N/NT/L4371T	LN4742V12T (12/24 V)
N/NT/L4371R	LN4742V127T (127 V)
N/NT/L4371V	LN4742V230T (230 V)
N/NT/L4372AV (2 LED)	
N/NT/L4373H (2 LED)	LN4742V12T (12/24 V)

EXAMPLES OF LED CONNECTION ON A SWITCH

CONTROL BACKLIGHTING LED CONNECTION

Note for the connection of 230 V.a.c. LEDs for the backlighting of control devices: when LEDs are fitted to help locate the control itself, it must be taken into account that energy saving and fluorescent lamps do not allow in series connection of the LED on the load. It is therefore necessary to also take a neutral conductor near the control, so that the LED may be connected directly between phase and neutral, and will always be on.

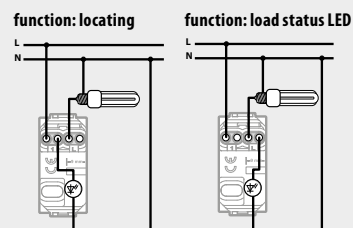

Livinglight TRADITIONAL ELECTRICAL SYSTEM

Supports

2 MODULE AREA

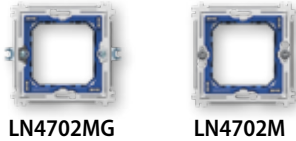

LN4702MG

LN4702M

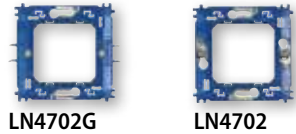

LN4702G

LN4702

3 MODULE AREA



L4702G

L4702

LN4719G*

LN4719*

*(Installs with only cover plate art. LNA4819 ...)



LN4703

LN4704

LN4707

LN4726





Item	2 MODULE AREA INSTALLATION - METALLIC SUPPORT
○ LN4702MG	2 module support - clip fastening
○ LN4702M	2 module support - screw fastening
2 MODULE AREA INSTALLATION - PLASTIC SUPPORT	
○ LN4702G	2 module support - clip fastening
○ LN4702	2 module support - screw fastening

Item	3 MODULE AREA INSTALLATION - PLASTIC SUPPORT
○ L4702G	2 module support - clip fastening
○ L4702	2 module support - screw fastening
○ LN4719G	2 central module support - for item LNA4819.. - clip fastening
○ LN4719	2 central module support - for item LNA4819... - screw fastening
○ LN4703	3 module support - screw fastening
○ LN4704	4 module support - screw fastening
○ LN4707	7 module support - screw fastening
○ LN4726	3+3 module support - screw fastening



LN4782

LN4783

Item	PROTECTION SHEATHS
○ LN4782	 protection sheath for 2 module LIVING support item LN4702G and LN4702 - can be used during finishing plastering works
○ LN4783	 protection sheath as above for 3 module support item LN4703
○ LN4784	 protection sheath as above for 4 module support item LN4704
○ LN4787	 protection sheath as above for 7 module support item LN4707
○ LN4786	 protection sheath as above for 3+3 module support item LN4726

MATCHING TABLE BETWEEN SUPPORTS AND PROTECTION SHEATH

	Support Item	Protection sheath to outfit	Protection sheath item
Livinglight	LN4702MG	YES	
	LN4702M	YES	
	LN4702G	NO	LN4782
	LN4702	NO	LN4782
	L4702G	NO	
	L4702	NO	
	LN4719G	NO	
	LN4719	NO	
	LN4703	NO	LN4783
	LN4704	NO	LN4784
	LN4707	NO	LN4787
LN4726	NO	LN4786	

Livinglight AIR

TRADITIONAL ELECTRICAL SYSTEM

Supports

2 MODULE AREA



LN4702E

3 MODULE AREA



LN4702C

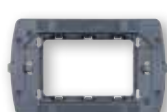

LN4703C



LN4704C



LN4707C



LN4726C

Item	AIR - 2 MODULE AREA INSTALLATION SYSTEM
○ LN4702E	2 module support for AIR cover plates series LNE... - single use or 2+2 and 2+2+2 couplings modules



Item	AIR - 3 MODULE AREA INSTALLATION SYSTEM
○ LN4702C	2 module support for AIR cover plates series LNC... - screw fastening
○ LN4703C	3 module support for AIR cover plates LNC... - screw fastening
○ LN4704C	4 module support for AIR cover plates LNC... - screw fastening
○ LN4707C	7 module support for AIR cover plates LNC... - screw fastening
○ LN4726C	3+3 module support for AIR cover plates LNC... - screw fastening



LN4783C

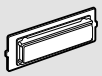

LN4784C

Item	PROTECTION SHEATHS
○ LN4783C	 protection sheath as above for 3 module support item LN4703C
○ LN4784C	 protection sheath as above for 4 module support item LN4704C
○ LN4787C	 protection sheath as above for 7 module support item LN4707C

MATCHING TABLE BETWEEN SUPPORTS AND PROTECTION SHEATH			
	Support Item	Protection sheath to outfit	Protection sheath item
Livinglight AIR	LN4702E	YES	
	LN4702C	NO	
	LN4703C	NO	LN4783C
	LN4704C	NO	LN4784C
	LN4707C	NO	LN4787C
	LN4726C	NO	

Livinglight TRADITIONAL ELECTRICAL SYSTEM

Accessories



503CG



503EV



503DE



503ED

ACCESSORIES

○ 503CG		protecting cover for flush mounted box item 503E - can be used during finishing plastering works
○ 503EV		resin internal divider for boxes item 503E - for the separation of data and power circuits
○ 503EC		front cover for flush mounted box item 503E - for closing when used as junction box - can be painted
○ 504EC		cover as above for boxes item 504E
○ 506EC		cover as above for boxes item 506E
○ 503DE		resin internal divider - for boxes item 504E
○ 503ED		coupler for boxes 502E, 503E, 504E (horizontal and vertical) and box 506L (vertical only). Do not use with box extension.
○ 500/02		pair of 30 mm screws for the installation of the supports on boxes fitted below the wall plaster line

ACCESSORY FOR HOLLOW MILLING CUTTER

○ PBD68		disk-type cutter for the installation of plasterboard boxes
---------	--	---

Note: PBD68 is an accessory used with the hollow milling cutter, diameter 68 mm, for the installation of BTicino boxes for plasterboard PBS... This disk creates a reduction which allows the box to be flush mounted with the wall.

3 module area installation system accessories



Box extension



Box already installed

Surround plate for AIR

LIVINGLIGHT AIR

Item		BOX EXTENSION
○ 503ESE		adapter, for increasing the depth of 503E flush mounted boxes
○ 504ESE		adapter, for increasing the depth of 504E flush mounted boxes
○ 506LSE		adapter, for increasing the depth of 506L flush mounted boxes
○ 506ESE		adapter, for increasing the depth of 506E flush mounted boxes

These adapters may be used when installing the box. They make wiring easier in case of several cables inside the same box, or for particularly deep devices.

PRODUCTS FOR WHICH THE USE OF THE BOX EXTENSION IS NECESSARY, WHEN INSTALLED WITH LIVINGLIGHT AIR (3 MODULE INSTALLATION SYSTEM)

Box extension	Products to combine	Item
10 A 2 modules	resistive dimmer with built-in two-way switch - 1 module	<input type="checkbox"/> N4402N <input type="checkbox"/> NT4402N <input type="checkbox"/> L4402N
	1 module resistive dimmer	<input type="checkbox"/> N4406 <input type="checkbox"/> NT4406 <input type="checkbox"/> L4406
	10 A 1 module axial pushbutton + MH BASIC interface	<input type="checkbox"/> N4055A <input type="checkbox"/> NT4055A <input type="checkbox"/> L4055A
	10 A 2 module axial pushbutton + MH BASIC interface	<input type="checkbox"/> N4055M2A <input type="checkbox"/> NT4055M2A <input type="checkbox"/> L4055M2A
	230 Va.c. shaver socket	<input type="checkbox"/> N4177 <input type="checkbox"/> NT4177 <input type="checkbox"/> L4177

SURROUND PLATES FOR LIVINGLIGHT AIR (3 MODULE INSTALLATION SYSTEM)

In case of refurbishment using existing boxes (with minimum depth 50 mm) **the box extension cannot be used**. The following is therefore recommended:

○ 503ESC		surround plate for the installation of LIVINGLIGHT AIR on existing 503E flush mounted box
○ 504ESC		surround plate for the installation of LIVINGLIGHT AIR on existing 504E flush mounted box
○ 506LSC		surround plate for the installation of LIVINGLIGHT AIR on existing 506L flush mounted box
○ 506ESC		surround plate for the installation of LIVINGLIGHT AIR on existing 506E flush mounted box



LIVINGLIGHT MyHOME



Thanks to MyHOME technology, it is possible to design electric systems with new more advance performances in terms of comfort, safety, energy saving, audio/video communication, local or remote control.

LIVINGLIGHT MyHOME is based on the use of one single system technology, the digital Bus, which can be applied in all residential solutions. The system can be expanded at any time and can be integrated with systems and devices with different communication protocols.

Livinglight

MyHOME SYSTEM

Integration and control



344842



344844



346020



MyHOMEServer1



3488

Item **CLASSE 300EOS WITH NETATMO CONNECTED VIDEO INTERNAL UNIT**

- 344842 2 wires/Wi-Fi handsfree connected video internal unit with built-in Amazon Alexa voice assistant, 5" vertical touch screen LCD display and video door entry answering machine. It has a physical key for door lock release and capacitive keys for the control of the main video door entry functions: handsfree communication, entrance panel activation /camera scrolling and Favourite key (can be configured to activate the quick actions most frequently used – e.g. additional door locks, staircase light control, intercom). There are notification LEDs for: Wi-Fi network connection status, info / notifications and call exclusion. It is possible to easily interact with the built-in Alexa voice assistant, either using the dedicated capacitive keys or with your voice, and activate several functions, such as the video door entry functions, Smart Home, scenarios, reminders etc. Using the touch display, it is possible to access the notification list, as well as your favourite door entry, security and Smart Home controls (if any). Possibility of voice communication with the switchboard - if present in the system - after a specific call. The device must be configured by physically connecting the configurators, or using the menu, which will give better possibilities of customisation of associated functions and texts. Thanks to the Wi-Fi connection, you can associate the video internal unit to the Home + Security App (available for Android and iOS). The App allows to use the main video internal unit functions (receiving calls, door lock release, display of the event timeline and activation of the entrance panel/camera cycling). Through the Home + Security App, it is also possible to manage the products of the Netatmo security range (outdoor and indoor cameras, door and window sensors, indoor siren and smoke detector). This allows you to quickly and easily create a Smart security system. The device also allows to create and manage Smart Home functions, using the wired SCS BUS solution server, without the need for adding dedicated gateways. Wall mounted installation using the supplied bracket Possibility of Wi-Fi connection or using RJ45 ethernet cable with the dedicated accessory 344844.

ETHERNET ACCESSORY

- 344844 Accessory cable for the wired connection of the Classe 300EOS video internal unit using an RJ45 Ethernet cable. To be purchased separately.

2 DIN ADDITIONAL POWER SUPPLY

- 346020 Additional 2 DIN power supply to be used to supply the connected CLASSE 300EOS video internal unit (344842) locally, when required.

APP:



Home + Control



Home + Security



Home + Project



GET IT ON Google Play

Item **HOMETOUCH - TOUCH SCREEN 7"**

- 3488W
- 3488



HOMETOUCH - Touch Screen 7" for the management of all MyHOME_Up functions, that can be integrated with the video door entry system and with indoor and outdoor Netatmo cameras, to be used as connected internal unit. To use the home automation functions, configuration is not necessary. It is possible to display the MyHOME_Up system status and control the integrated functions (lights, automation, scenarios, temperature management, Nuvo music system, ...). Thanks to the "DOOR ENTRY for HOMETOUCH" application, available both for Android and iOS operating systems, it is also possible to manage the video door entry functions of a BTicino 2 wires system using the 7" capacitive display or the Smartphone. Flush mounted installation with box for masonry walls (item 3487) or wall mounted installation with the supplied metal bracket. Available in tech grey and in white.

BOX FOR FLUSH MOUNTED INSTALLATION

- 3487



box for flush mounted installation of the HOMETOUCH Touch screen item 3488 and 3488W. Width 197 mm, height 148 mm and depth 52 mm.

- 3487AP



support for flush mounted installation on plasterboard walls of the HOMETOUCH Touch screen item 3488 and 3488W.

CONTROL SERVER USING THE APP

- MyHOMEServer1



server to associate devices during the system starting-up and for the local and remote management of the functions by the user with the specific MyHOME_Up application for Android and iOS smartphones or tablets.

MyHOMEServer1 KIT

- MHSERVERKIT

kit containing MyHOMEServer1 and Access Point for communication between the MyHOME system to which it is connected, and a smartphone or tablet where the MyHome App is installed.

Note: For the details of the products managed by MyHome_Up and the compatible products, see the corresponding guide.

DRIVER MANAGER

- F459



integration platform with other brand systems - 6 DIN modules

Contact the BTicino System Integration Service to check the feasibility of specific integrations and to request the licence needed to use the Driver manager

Lights and shutter automation



L4652/2



L4652/3



L4680



F428



F425

Item		CONTROLS FOR SINGLE OR DOUBLE LOADS	
○ L4652/2		control which can drive a single actuator for single or double loads or two actuators for single loads or independent double loads – to be completed with 1 2-module key cover for controls with one or two functions or 2 1-module key covers with one or two functions - 2 modules	
○ L4652/3		control which can drive three actuators for single or double loads or two actuators for single loads or independent double loads – to be completed with 3 1-module key covers for controls with one or two functions - 3 modules	
		CONTROL FOR SHUTTER MANAGEMENT	
○ LN4660M2		2 module flush mounted control with reduced thickness with 3 pushbuttons. In addition to monostable and bistable UP/DOWN operation, the device also places the shutter in a stored (PRESET) position. Only suitable for operation with advanced actuators LN4661M2 and F401, specific for the management of shutters.	
		CONTROL FOR SPECIAL FUNCTIONS	
○ L4651M2		special control – can drive an actuator performing all the standard functions of a control and in addition some special functions: activation of 4 scenarios, timings, activation of an actuator installed on a different bus than the control, selection of the fixed adjustment level and the dimmer soft-start and soft-stop speed, sound system, door lock switching on control, call to the floor and switching on staircase light control and management of auxiliary channels. To be completed with 1 or 2-module key covers with one or two functions - 2 modules	
		SCENARIO CONTROL	
□ N4680 ■ NT4680 ■ L4680		customisable scenario control for the activation of up to 4 Automation, Temperature Control and Sound System independent scenarios saved in the F420 scenario module - 2 modules.	
○ LN4652		8-KEY control for light management, shutter automation, sound system and scenarios - SCS-BUS connection - sizes: 2 modules	
		A5 sheets for the customisation of the control symbols item LN4652. The sheets can be customised using the tool found in the MyHOME_Suite configuration software.	
○ 3541		black	
○ 3542		white	
		HOME-AUTOMATION HINGE	
○ 4911TDM		accessory for the installation of 2-module key covers on devices installed in 503E box	
		CONTACT INTERFACE	
○ 3477		basic module control interface with 2 independent contacts for the control of 2 actuators for single function loads, or 1 actuator for double function loads (shutters) – the inputs accepts two traditional switches or pushbuttons with NO and NC contact, or a traditional two-way switch, or interlocked pushbuttons	
○ F428		as above - 2 DIN modules	
		MEMORY MODULE	
○ F425		module for saving the status of the actuators - to reset the light Automation system in case of blackout - 2 lowered DIN modules	

Livinglight

MyHOME SYSTEM

Lights and shutter automation



LN4672M2



3476

Item

LIGHT AND SHUTTER CONTROL/ACTUATOR

○ LN4672M2



actuator/control with 2 independent relays - for single, double or mixed loads: 1380 W resistive, 1380 W incandescence lamps, 460 W for reducer motors, 460 VA $\cos\phi$ 0.5 for ferromagnetic transformers and 250 W for fluorescent lamps - logic relay interlock via configuration. The device can be also configured to manage a remote actuator - 2 modules.

Item

SHUTTER CONTROL/ACTUATOR

○ LN4661M2



2 module flush mounted actuator with 2 internal relays and 4 pushbuttons. In addition to monostable and bistable UP/DOWN operation, the actuator also places the shutter in a stored (PRESET) position. To be combined with control devices LN4660M2

○ 3476

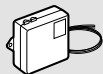

LIGHT CONTROL/ACTUATOR

1 relay actuator - for single loads: 2 A resistive or incandescence lamps, 2 A $\cos\phi$ 0.5 for ferromagnetic transformers - a traditional pushbutton with NO contact accepted in input

LOADS THAT CAN BE DRIVEN (230 Va.c. 50/60 Hz)							
Actuators	Type						
	Energy saving incandescence and halogen lamps	LED lamps	Linear fluorescent lamps ¹⁾	Compact fluorescent lamps	Electronic transformers ³⁾	Ferromagnetic transformers ^{2) 3)}	Reducer motors for shutters ⁴⁾
LN4672M2	1380 W	250 W Max 2 lamps	250 VA	250 W Max 2 lamps	460 W	460 VA	460 W
3476	2 A 460 W	40 W Max 1 lamp	-	40 W Max 1 lamp	-	2 A $\cos\phi$ 0,5 460 VA	-
LN4661M2	-	-	-	-	-	-	2 A 250 Va.c.

Notes:

- 1) Power factor corrected fluorescent lamps, discharge lamps.
- 2) Account must be taken of the transformer yield to calculate the effective power of the load connected to the actuator. For example if a dimmer is connected to a 100 VA ferromagnetic transformer with yield 0.8, the effective power of the load will be 125 VA.
- 3) The transformer must be loaded at its rated power and however never less than 90% of this power. It is preferable to use a single transformer rather than several transformers in parallel. For example it is better to use a single 250 VA transformer with 5 50W spotlights connected rather than use 5 50 VA transformers in parallel each with a 50 W spotlight.
- 4) The symbol on the actuators refers to the shutter reducer motors.



F411U2



F411/4



BMSW1003



F401

Item	ACTUATORS FOR CENTRALISATIONS	
○ F411U2		actuator with 2 independent relays – for single and double loads: 10 A resistive and 6 A incandescence lamps, 500 W for reducer motors, 2 A $\cos\phi$ 0,5 for ferromagnetic transformers and 250 W for fluorescent lamps - logic relay interlock via configuration - it has "Zero crossing" technology - 2 DIN modules
○ F411/4		actuator with 4 independent relays - for single, double or mixed loads: 2 A resistive, 2 A incandescence lamps, 500 W for reducer motors, 2 A $\cos\phi$ 0,5 for ferromagnetic transformers and 70 W for fluorescent lamps - logic relay interlock via configuration - 2 DIN modules

Item	ACTUATORS FOR CENTRALISATIONS	
○ BMSW1003		ON/OFF actuator, 4 independent outputs with maximum load 16 A at 230 Va.c., clamp connection and RJ45, IP20 protection index, power supply 100/240 Va.c. 50/60 Hz, pushbuttons for load direct control - zero-crossing function - 6 DIN modules
○ BMSW1005		ON/OFF actuator, "Zero Crossing" technology, 8 independent outputs with maximum load 16 A at 230 V a.c., clamp connection, IP20 protection index, power supply 100/240 V a.c. 50/60 Hz, pushbuttons for load direct control - 10 DIN modules
○ F401		actuator with 2 internal relays and 4 pushbuttons. In addition to monostable and bistable UP/DOWN operation, the actuator also places the shutter in a stored (PRESET) position - 2 DIN modules

LOADS THAT CAN BE DRIVEN (250 Va.c. 50/60 Hz)							
Actuators	Type						
	Energy saving incandescence and halogen lamps	LED lamps	Linear fluorescent lamps ¹⁾	Compact fluorescent lamps	Electronic transformers ³⁾	Ferromagnetic transformers ^{2) 3)}	Reducer motors for shutters ⁴⁾
F411U2	10 A 1380 W	250 W Max 4 lamps	4 A 230 W	250 W Max 4 lamps	4 A 230 W	4 A $\cos\phi$ 0,5 460 VA	2 A 460 W
F411/4	2 A 460 W	70 W Max 2 lamps	0.3 A 70 W	70 W Max 2 lamps	0.3 A 70 W	2 A $\cos\phi$ 0,5 460 VA	2 A 460 W
BMSW1003	16 A 3680 W	2.1 A 500 VA	10 X (2 X 36 W) 4.3 A	1150 W 5 A	16 A 3680 W	16 A 3680 W	-
BMSW1005	16 A 3680 W	2.1 A 500 VA	4.3 A 10X2X36 W	5 A 1150 VA	16 A 3680 W	16 A 3680 W	-
F401							2 A 250 Va.c.

Notes:

- 1) Power factor corrected fluorescent lamps, discharge lamps.
- 2) Account must be taken of the transformer yield to calculate the effective power of the load connected to the actuator. For example if a dimmer is connected to a 100 VA ferromagnetic transformer with yield 0.8, the effective power of the load will be 125 VA.
- 3) The transformer must be loaded at its rated power and however never less than 90% of this power. It is preferable to use a single transformer rather than several transformers in parallel. For example it is better to use a single 250 VA transformer with 5 50W spotlights connected rather than use 5 50 VA transformers in parallel each with a 50 W spotlight.
- 4) The symbol on the actuators refers to the shutter reducer motors.

Livinglight

MyHOME SYSTEM

Lights and shutter automation



F413N



BMD11002





F429





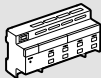

F416U1



F418U2

Item	DIMMERS FOR CENTRALISATIONS	
○ F413N		1-output dimmer to supply fluorescent lamps or LED sources with input 1-10 V for single loads up to 2.5 A at 230 Va.c. – type of screw connection - power supply 27 Vd.c. – absorption 30 mA – max 10 ballast that can be connected (clamps 1-2) - with pushbutton for load direct control - version for fastening on DIN rail - 2 modules
○ BMD11002		1/10V dimmer, “Zero Crossing” technology, 4 outputs with maximum load 4.3 A at 230 V a.c., clamp connection, IP20 protection index, power supply 100/240 V a.c. 50/60 Hz, pushbuttons for load direct control - 10 DIN modules
○ F429		DALI dimmer with 8 independent outputs for the connection of up to 16 DALI reactors for each output – 230 V a.c. power supply 50/60 Hz; 110 - 240 Vd.c. – absorption 5 mA - with pushbutton for load direct control - version for fastening on DIN rail - 6 modules

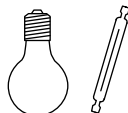
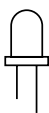
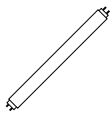
Item	MULTI-LOAD DIMMERS FOR CENTRALISATIONS	
○ F416U1		multi-load dimmer, 1 output with maximum load 4.3 A at 230 Va.c., clamp connection and RJ45, IP20 protection index, power supply 100/240 Va.c. 50/60 Hz, pushbutton for load direct control - 6 DIN modules
○ F418U2		two-channel dimmer for the management of dimmer LEDs, dimmer compact fluorescent lamps (CFL), energy saving halogen lamps and electronic transformers at 110-230V. Possibility of parallelisation of the two channels to increase the maximum power which can be managed. power supply 27 Vd.c., absorption 18 mA - version for fastening on DIN rail - 4 modules

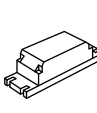
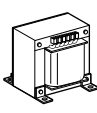
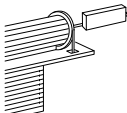
LOADS THAT CAN BE DRIVEN (230 Va.c. 50/60 HZ)							
Actuators	Type						
							
	Energy saving incandescence and halogen lamps	LED lamps	Linear fluorescent lamps ¹⁾	Compact fluorescent lamps	Electronic transformers ³⁾	Ferromagnetic transformers ^{2) 3)}	Reducer motors for shutters ⁴⁾
BMD11002	Dimmer for ballast - 4 x 4.3 A outputs - 4x 1000VA@ 230 Vac - 4x500VA@ 230 Vac						
F413N	-	-	2 A 460 W ⁵⁾ Max 10 ballast, type T5, T8, compact or driver for LED	-	-	-	-
F416U1	4.3 A 40 - 1000 W	-	-	-	4.3 A 40 - 1000 W	4.3 A 40 - 1000 W	-
F418U2	2x300 W	2x300 VA	-	2x300 VA	2x300 VA	2x300 VA	-
F429	SCS/DALI dimmer interface - 8 x16 ballast						

Notes:

- 1) Power factor corrected fluorescent lamps, discharge lamps. 2) Account must be taken of the transformer yield to calculate the effective power of the load connected to the actuator. For example if a dimmer is connected to a 100 VA ferromagnetic transformer with yield 0.8, the effective power of the load will be 125 VA.
- 3) The transformer must be loaded at its rated power and however never less than 90% of this power. It is preferable to use a single transformer rather than several transformers in parallel. For example it is better to use a single 250 VA transformer with 5 50W spotlights connected rather than use 5 50 VA transformers in parallel each with a 50 W spotlight.
- 4) The  symbol on the actuators refers to the shutter reducer motors. 5) Only compatible with lamps with 1/10 V ballast.

Light sensor



L4658N



N4659N



Item	PIR+US DOUBLE TECHNOLOGY GREEN SWITCH	PIR PASSIVE INFRARED GREEN SWITCH
<input type="checkbox"/> N4658N <input checked="" type="checkbox"/> NT4658N <input checked="" type="checkbox"/> L4658N	 <p>Green Switch: double technology presence sensor, passive IR and ultrasound (PIR+US), suitable for the detection of presence in working areas (offices, meeting rooms). With manual ON/OFF pushbutton. Operating mode (automatic or manual), time delay (5 s to 59 min), and brightness threshold (20 to 1275 LUX) settable using the advanced/basic (BMS04001/BMS04003) configuration remote control; physical or virtual configuration. 2 modules</p>	 <p>Green Switch: passive IR (PIR) sensor, suitable for the detection of presence in transit areas (corridors, toilets, service rooms). Operating mode (automatic or manual), time delay (5 s to 59min), and brightness threshold (20 to 1275 LUX) settable using the advanced/basic (BMS04001/BMS04003) configuration remote control; physical or virtual configuration. 2 modules</p>

DIAGRAM FOR THE USE OF THE GREEN SWITCH, ITEM L/N/NT4658N



ECO MODE

Manual load activation and automatic switch off managed by the dimmer/actuator based on the detection of the presence of people and the desired level of illumination detected by the control, item L4658N. The function of the control is first of all to activate the automatism of the dimmer/actuator: upon first pressure, the sensor compares the desired light level with the actual light level of the room, and ascertains if the light should be switched on or not. A subsequent pressure of the control forces the switching ON or OFF of the automatism determined by the dimmer/actuator.

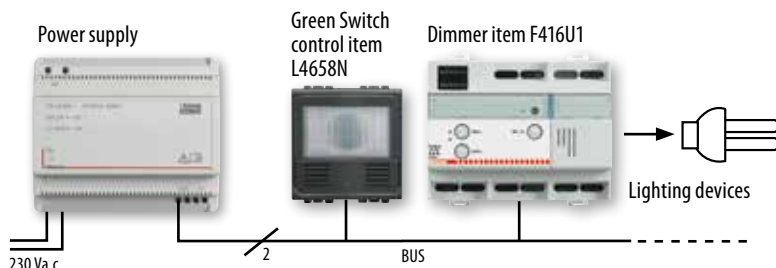
Livinglight MyHOME SYSTEM

Light sensor



BMSE3001



BMSE3003



0 882 40



BMSO4003

Item		LIGHTING/MOVEMENT SENSORS	Item	REMOTE CONTROL AND CONFIGURATION GATEWAY
○ BMSE3001		passive infrared SCS sensor for the detection of movement and the lighting level. Ceiling flush mounted installation using springs or installation boxes; surface installation using surface installation box, item 048875; IP20 protection index; RJ45 clamp connection; 8 m (50 m ²) diameter coverage area for a 2.5 m installation height, maximum installation height 6 m; 27 V d.c. power supply from bus, absorption 12 mA; regulation with basic/advanced remote control (BMSO4003 and BMSO4001) or through configuration software, of the lighting level, from 5 to 1275 LUX, of the time delay, from 30 s to 255 h, and of the main operating parameters; Push&Learn pushbutton	0 882 40	The Gateway allows you to adjust the time delay, the brightness threshold and the detection sensitivity. Possibility to store, share, prepare all of the product settings for a construction site advance. Possibility of duplicating the parameters of a product 0 882 40. Works with the App "Legrand Close Up" available on Google Play and Apple Store via Bluetooth Low Energy technology for smartphone. Allows the configuration of windows, management systems lighting and emergency lighting units and offers advanced features to facilitate the management of facilities.
○ BMSE3003		double technology SCS sensor: passive infrared for the detection of presence and the lighting level. Ceiling flush mounted installation using springs or installation boxes; surface installation using surface installation box, item 048875; IP20 protection index; RJ45 clamp connection; 8 m diameter (50 m ²) infrared coverage area for a 2.5 m installation height, 11 mm diameter (95 m ²) ultrasound coverage area for a 2.5 m installation height, maximum installation height 6 m; 27 V d.c. power supply from BUS, absorption 17 mA; regulation with basic/advanced remote control (BMSO4003 and BMSO4001), or through configuration software, of the lighting level, from 5 to 1275 LUX, of the delay, from 30 s to 255 h, and of the main operating parameters; Push&Learn pushbutton	○ BMSO4003	the basic configuration remote control, with IR transmitter, adjusts the main operating parameters of: Switch Sensor, Green Switch and SCS compatible sensors. Modification of parameters only possible for preset values, battery recharge not available
			○ 048875	INSTALLATION ACCESSORIES ceiling mounted box compatible with the sensors: BMSE3001 and BMSE3003, IP20 protection index, dimensions Ø 100 x 50 mm

FEATURES OF THE LIGHTING/MOVEMENT SENSORS

SCS SENSORS	BMSE3001	BMSE3003
INSTALLATION	ceiling flush mounted	
TYPE OF OPERATION	AUTO/ECO/WALKTHROUGH	
SENSOR TECHNOLOGY	PIR	PIR+US
POWER SUPPLY	27 V d.c. from Bus	
PROTECTION INDEX	IP20	
COVERAGE AREA AT 2.5 m	Ø 8 m	Ø 11 m
COVERAGE ANGLES (v/h)	90/360°	
LIGHTING LEVEL	5 lux - 1275 lux	
SWITCHING OFF DELAY	30 s - 255 h 59 min 59 sec	
FACTORY ADJUSTMENTS	300 lux - 15 min	
CONNECTION TYPE	RJ45 connector	

Temperature control



LN4691



N4693



3454

Item		PROBE WITH DISPLAY
○ LN4691		flush mounted device with backlit display. It can be used to control the temperature of an individual zone, irrespective of a temperature control central unit being installed as part of the system or not. It has a temperature probe and an input for the connection of a contact line (e.g. window contact). It can be used for the management of different types of systems, and the adjustment of the fan speed when fan coils are used. Possibility of automatic operation (summer/winter) with compatible systems. bus SCS connection – 2 modules.

		SLAVE PROBE
□ N4693		probe to control the room temperature for heating and cooling systems – temperature measurement range 3–40 °C - 2 modules
■ NT4693		
■ L4693		



Item		PROBE WITHOUT DISPLAY
○ 3454		temperature probe in basic module with wired sensor - to be associated to the temperature sensor item 3457 and Vantage probe item 8051

		ACCESSORIES
○ 3457		temperature probe to be associated to the probe item 3454

		ACTUATORS
○ F430/2		actuator with 2 independent relays – for single and double loads: 6 A resistive, 2A motor driven valves and pumps - configuration based logic relay interlock - 2 DIN modules
○ F430/4		actuator with 4 independent relays - for single, double or mixed loads: 4 A resistive, 1 A motor driven valves, pumps and fan coils - configuration based logic relay interlock - 2 DIN modules
○ F430R8		actuator with 8 independent relays for the control of on-off valves, motorised valves (open-close and three points), pumps and fan coils with 2 and 4 tubes - 4A resistive, 1A motor valves, pumps and fan-coils- SCS-bus connection - 4 DIN modules
○ F430R3V10		actuator with 3 independent relays and 2 x 0-10 Volts outputs for the control of fan coils with 2 and 4 tubes with proportional 0-10 Volt valves - 4A resistive, 1A fan coil - SCS-BUS connection - 4 DIN modules
○ F430V10		actuator with 2 x 0-10 Volt outputs for the control of 0-10 proportional valves - SCS-BUS connection - 2 DIN modules

Livinglight MyHOME SYSTEM Energy Management



Item	CONSUMPTION DISPLAY	
○ F520		meter for the measurement of electricity on a maximum of 3 lines, by connecting 3 toroids to the appropriate inputs. Version for fastening on DIN rail - 1 module. The device is fitted with 1 toroid.
○ 3523		Additional electricity meter toroid, item F520 and for actuator with sensor, item F522 for the measurement of the earth leakage current. Cable length 400 mm.

Item	LOAD CONTROL MANAGEMENT	
<input type="checkbox"/> N4672N <input checked="" type="checkbox"/> NT4672N <input checked="" type="checkbox"/> L4672N		1 relay actuator - 10 A for incandescence lamps and 4 A for fluorescent lamps or ferromagnetic transformers, and 500 W for compact fluorescent and LED lamps for the Automation and/or Load control management functions. Pushbutton for forced load operation - flush mounted version - 2 modules

Item	LOAD CONTROL MANAGEMENT	
○ F521		central unit for the management and control of the actuators of the load control system, to prevent the risk of detachment of the limiter of the electricity supplier. The central unit manages up to 63 loads, a contract power between 1.5 and 18 kW, and tolerance up to +/- 20%. It integrates an electricity meter for the controlled line. Version for fastening on DIN rail - 1 module. The device is fitted with 1 toroid.
○ F522		actuator with integrated current sensor for the measurement of the controlled load consumptions. 1 relay - 10 A for incandescence lamps and 4 A for fluorescent lamps or ferromagnetic transformers, and 500 W for compact fluorescent and LED lamps - Bistable relay with zero crossing for the Automation and/or Load control management functions. Version for fastening on DIN rail - 1 module. Earth leakage control by connecting the additional toroid, item 3523.
○ F523		1 relay actuator - for incandescence lamps and 4 A for fluorescent lamps or ferromagnetic transformers, and 500 W for compact fluorescent and LED lamps - bistable relay with zero crossing for the Automation and/or Load control management functions. Version for fastening on DIN rail - 1 module.

ACCESSORIES		
○ 3508BUS		removable clamp for BUS connection - width 3.81 mm
○ 3508U2		removable clamp 2 poles
○ 3508U3		removable clamp 3 poles

Common accessories and devices



E56



E49



L4669
L4669/500



336904

Item		POWER SUPPLIES
○ E56		power supply with input voltage 110 - 240 Vac @ 50 - 60 Hz. It provides two output power supplies in very low safety voltage (one of 27V DC 1.2A on the SCS terminals, one of 28.5V c.c. on terminal 1 - 2) to be used alternatively e NOT simultaneously. It can be used also as an additional power supply (output 1 - 2) for the local power supply of the devices automation (in this case it is not possible use no other output). The device is electronically protected against overload and short circuit. It is a device SELV double insulation safety device - Overall dimensions 6 DIN modules.
○ E49		compact power supply - input 230 Va.c. - output 27 Vd.c. Maximum current delivered 600 mA - 2 DIN modules.
		VARIOUS ACCESSORIES
○ 3515		spare removable clamp

Item		CONNECTION CABLES
○ L4669		sheathed pair made up of 2 flexible wires with unshielded plaited sheath - insulation 300/500 V - complies with standards CEI 46-5 and CEI 20-20 - coil length 100 metres
○ L4669/500		as above - in 500 m coils
○ L4669KM1		as above - reel length 1000 m (1)
○ 336905		as above - low toxicity cable without halogens - ideal for application in environments where fire hazard safety is critical - coil length 200 metres
○ 336904		specific cable with 2 twisted conductors. It can be installed in underground piping, in accordance with standards (CEI 20-13 and CEI 20-14). It ensures the best performance in video systems (higher distance between EP and Handset when compared with other cables). 200 m coil

System	Cable	
	L4669 L4669/500 L4669KM1 336905	336904
Automation	●	●(1)
Energy Management/Consumption Display	●	●(1)
Temperature control	●	●(1)
Video door entry system		●

NOTE (1): for systems underground cable sections

Livinglight

MyHOME SYSTEM

Key covers

2-FUNCTION NON-SILK-SCREEN PRINTED KEY COVERS



2-FUNCTION NON-SILK-SCREEN PRINTED KEY COVERS



NON-SILK-SCREEN PRINTED KEY COVERS - 1 FUNCTION		
	1 module	2 modules
	Item	Item
□	N4915LN	N4915M2LN
■	NT4915N	NT4915M2N
■	L4915N	L4915M2N

NON-SILK-SCREEN PRINTED KEY COVERS - 2 FUNCTIONS		
	1 module	2 modules
	Item	Item
□	N4911N	N4911M2N
■	NT4911N	NT4911M2N
■	L4911N	L4911M2N

1-FUNCTION SILK-SCREEN PRINTED KEY COVERS



NT4915AN NT4915M2ADN NT4915MR

2-FUNCTION SILK-SCREEN PRINTED KEY COVERS



NT4911AHN NT4911AIN

SILK-SCREEN PRINTED KEY COVERS WITH SYMBOLS - 1 FUNCTION

		1 module	2 modules
Description		Item	Item
DIMMER	<input type="checkbox"/>	—	N4915M2ADN
	<input type="checkbox"/>	—	NT4915M2ADN
	<input type="checkbox"/>	—	L4915M2ADN
STOP	<input type="checkbox"/>	N4915AEN	—
	<input type="checkbox"/>	NT4915AEN	—
	<input type="checkbox"/>	L4915AEN	—
LIGHT	<input type="checkbox"/>	N4915AN	N4915M2AN
	<input type="checkbox"/>	NT4915AN	NT4915M2AN
	<input type="checkbox"/>	L4915AN	L4915M2AN
STAIRCASE LIGHT	<input type="checkbox"/>	N4915BN	N4915M2BN
	<input type="checkbox"/>	NT4915BN	NT4915M2BN
	<input type="checkbox"/>	L4915BN	L4915M2BN
KEY	<input type="checkbox"/>	N4915FN	N4915M2FN
	<input type="checkbox"/>	NT4915FN	NT4915M2FN
	<input type="checkbox"/>	L4915FN	L4915M2FN
DO NOT DISTURB	<input type="checkbox"/>	N4915DD	N4915M2DD
	<input type="checkbox"/>	NT4915DD	NT4915M2DD
	<input type="checkbox"/>	L4915DD	L4915M2DD
DOORBELL	<input type="checkbox"/>	N4915DN	N4915M2DN
	<input type="checkbox"/>	NT4915DN	NT4915M2DN
	<input type="checkbox"/>	L4915DN	L4915M2DN
MAKE UP THE ROOM	<input type="checkbox"/>	N4915MR	—
	<input type="checkbox"/>	NT4915MR	—
	<input type="checkbox"/>	L4915MR	—

SILK-SCREEN PRINTED KEY COVERS WITH SYMBOLS - 2 FUNCTIONS

		1 module	2 modules
Description		Item	Item
ON - OFF - GEN	<input type="checkbox"/>	N4911AFN	N4911M2AFN
	<input type="checkbox"/>	NT4911AFN	NT4911M2AFN
	<input type="checkbox"/>	L4911AFN	L4911M2AFN
ON - OFF	<input type="checkbox"/>	N4911AGN	N4911M2AGN
	<input type="checkbox"/>	NT4911AGN	NT4911M2AGN
	<input type="checkbox"/>	L4911AGN	L4911M2AGN
UP - DOWN	<input type="checkbox"/>	N4911AHN	N4911M2AHN
	<input type="checkbox"/>	NT4911AHN	NT4911M2AHN
	<input type="checkbox"/>	L4911AHN	L4911M2AHN
ON - OFF ADJUSTMENT	<input type="checkbox"/>	N4911AIN	N4911M2AIN
	<input type="checkbox"/>	NT4911AIN	NT4911M2AIN
	<input type="checkbox"/>	L4911AIN	L4911M2AIN
+ up and - down	<input type="checkbox"/>	N4911ADN	—
	<input type="checkbox"/>	NT4911ADN	—
	<input type="checkbox"/>	L4911ADN	—

CUSTOMISABLE LIVINGLIGHT KEY COVERS WITH DIFFUSERS, AVAILABLE IN KIT

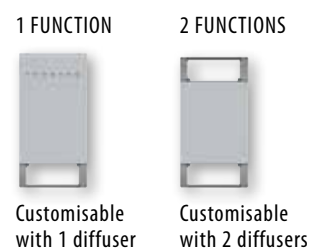

Customisable with 1 diffuser

Customisable with 2 diffusers

CUSTOMISABLE KEY COVERS

		1 module	2 modules
Description		Item	Item
1 FUNCTION CUSTOMISABLE KEY COVER WITH 1 DIFFUSER*	<input type="checkbox"/>	N4915TN	N4915M2TN
	<input type="checkbox"/>	NT4915TN	NT4915M2TN
	<input type="checkbox"/>	L4915TN	L4915M2TN
2 FUNCTION CUSTOMISABLE KEY COVER WITH 2 DIFFUSERS*	<input type="checkbox"/>	N4911TN	N4911M2TN
	<input type="checkbox"/>	NT4911TN	NT4911M2TN
	<input type="checkbox"/>	L4911TN	L4911M2TN

DIFFUSER KIT

Description	Item	
KIT WITH DIFFUSER ON THE SIDE (50 DIFFUSERS)	<input type="checkbox"/>	N4915SETBL
	<input type="checkbox"/>	NT4915SETBL
	<input type="checkbox"/>	L4915SETBL

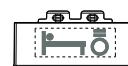

LIVINGLIGHT AIR - 2 MODULE AREA INSTALLATION SYSTEM

Cover plate installation

SELECTION TABLE









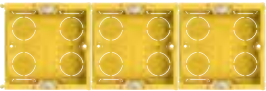

Plasterboard or flush mounted box	 <p>502E (70x70x50)</p>	 <p>2 x 502E (70x70x50)</p>	 <p>3 x 502E (70x70x50)</p>
Supports	 <p>LN4702E</p>	 <p>2 x LN4702E</p>	 <p>3 x LN4702E</p>
No. of modules	 <p>2 modules</p>	 <p>2 + 2 modules</p>	 <p>2 + 2 + 2 modules</p>
Cover plates	 <p>LNE4802..</p>	 <p>LNE4802M2...</p>	 <p>LNE4802M3...</p>

Table for selecting codes

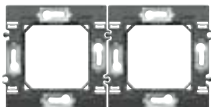
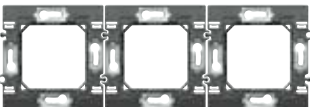











AIR COVER PLATE CODES

2 modules - LNE4802...

2 + 2 modules - LNE4802M2...

2 + 2 + 2 modules - LNE4802M3...

Cover plate modules

		2	2+2	2+2+2
MONOCHROME (zamak)				
	Pure white	LNE4802BN	LNE4802M2BN	LNE4802M3BN
	Tech	LNE4802TE	LNE4802M2TE	LNE4802M3TE
	Anthracite	LNE4802AR	LNE4802M2AR	LNE4802M3AR
SOFT (zamak)				
	Street	LNE4802ST	LNE4802M2ST	LNE4802M3ST
	Clay	LNE4802CY	LNE4802M2CY	LNE4802M3CY
	Sand	LNE4802SB	LNE4802M2SB	LNE4802M3SB
	Blue moon	LNE4802BM	LNE4802M2BM	LNE4802M3BM
SHINY (zamak)				
	Pewter	LNE4802PT	LNE4802M2PT	LNE4802M3PT
	Palladium	LNE4802PL	LNE4802M2PL	LNE4802M3PL
	Satin gold	LNE4802OF	LNE4802M2OF	LNE4802M3OF
	Satin nickel	LNE4802NK	LNE4802M2NK	LNE4802M3NK
	Pearl white	LNE4802PR	LNE4802M2PR	LNE4802M3PR

Supports

Supports	LN4702E	LN4702E x 2	LN4702E x 3

LIVINGLIGHT AIR - 2 MODULE AREA INSTALLATION SYSTEM











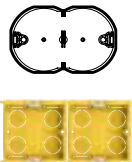
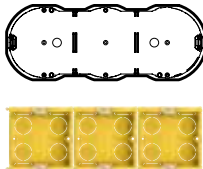
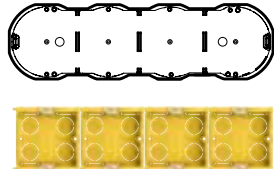





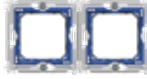
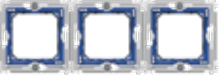
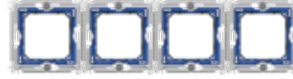



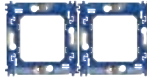
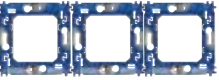

Cover plate finishing



LIVINGLIGHT SQUARE COVER PLATES - 2 MODULE AREA INSTALLATION SYSTEM

Cover plate installation

SELECTION TABLE

	BOTH FOR HORIZONTAL AND VERTICAL INSTALLATION - CENTRE DISTANCE 71 mm			
Boxes	 502E (screw) (70x70x50)	 2 x 502E (screw) (70x70x50)	 3 x 502E (screw) (70x70x50)	 4 x 502E (screw) (70x70x50)
Metallic supports	 LN4702MG (clips)	 LN4702MG (clips)	 LN4702MG (clips)	 LN4702MG (clips)
	 LN4702M (screw)	 LN4702M (screw)	 LN4702M (screw)	 LN4702M (screw)
Supports	 LN4702G (clips)	 LN4702G (clips)	 LN4702G (clips)	 LN4702G (clips)
	 LN4702M (screw)	 LN4702 (screw)	 LN4702 (screw)	 LN4702 (screw)
No. of modules	 2 modules	 2 + 2 modules	 2 + 2 + 2 modules	 2 + 2 + 2 + 2 modules
Cover plates	 LNA4802..	 LNA4802M2...	 LNA4802M3...	 LNA4802M4...









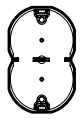
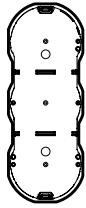

Note: The clear protection is supplied as standard with LN4702MG and LN4702M supports, to preserve the integrity of the devices, protecting them from installation dust, paint and scratches during all stages after their installation, and until the cover plates are fitted.

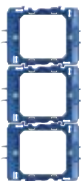
LIVINGLIGHT SQUARE COVER PLATES

- 2 MODULE BELGIAN INSTALLATION SYSTEM

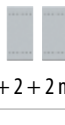
Cover plate installation

SELECTION TABLE

	VERTICAL INSTALLATION CENTRE DISTANCE 57 mm	
Boxes		
Supports	  LN4702G (clips) LN4702 (screw)	  LN4702G (clips) LN4702 (screw)
No. of modules	 2 + 2 modules	   2 + 2 + 2 modules
Cover plates	 LNA4832M2...	 LNA4832M3...

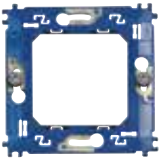
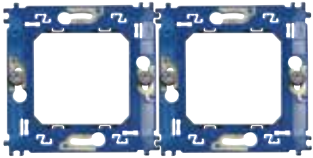
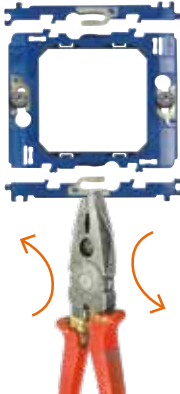
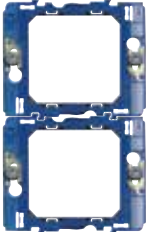
INSTALLATION OF LN4702 AND LN4702G SUPPORTS		
 LN4702 (fixing with screw)	<p>71 mm centre distance installation</p>  To place side by side 2 or more supports	<p>57 mm centre distance installation</p>  <p>Before placing side by side 2 or more supports, detach upper and lower sides as indicated</p> 

LIVINGLIGHT SQUARE COVER PLATES - 2 MODULE AREA INSTALLATION SYSTEM











Table for selecting codes

		MODULES					
		2	2+2 Centre distance 71 mm	2+2+2 Centre distance 71 mm	2+2+2+2 Centre distance 71 mm	2+2 Centre distance 57 mm	2+2+2 Centre distance 57 mm
METALS (zamak)							
	Ice gold	LNA4802OA	LNA4802M2OA	LNA4802M3OA	LNA4802M4OA	LNA4832M2OA	LNA4832M3OA
	Bronze	LNA4802BZ	LNA4802M2BZ	LNA4802M3BZ	LNA4802M4BZ	LNA4832M2BZ	LNA4832M3BZ
NATURALIA (zamak)							
	Native	LNA4802NA	LNA4802M2NA	LNA4802M3NA	LNA4802M4NA	LNA4832M2NA	LNA4832M3NA
	Silver	LNA4802AG	LNA4802M2AG	LNA4802M3AG	LNA4802M4AG	LNA4832M2AG	LNA4832M3AG
	Brushed steel	LNA4802ACS	LNA4802M2ACS	LNA4802M3ACS	LNA4802M4ACS	LNA4832M2ACS	LNA4832M3ACS
SILK (zamak)							
	Park	LNA4802PK	LNA4802M2PK	LNA4802M3PK	LNA4802M4PK	LNA4832M2PK	LNA4832M3PK
	Square	LNA4802SQ	LNA4802M2SQ	LNA4802M3SQ	LNA4802M4SQ	LNA4832M2SQ	LNA4832M3SQ
	Brick	LNA4802RK	LNA4802M2RK	LNA4802M3RK	LNA4802M4RK	LNA4832M2RK	LNA4832M3RK
	Avenue	LNA4802AE	LNA4802M2AE	LNA4802M3AE	LNA4802M4AE	LNA4832M2AE	LNA4832M3AE
	Club	LNA4802CB	LNA4802M2CB	LNA4802M3CB	LNA4802M4CB	LNA4832M2CB	LNA4832M3CB
DEEP (polymer plastic)							
	Green	LNA4802VD	LNA4802M2VD	LNA4802M3VD	LNA4802M4VD	LNA4832M2VD	LNA4832M3VD
	Orange	LNA4802OD	LNA4802M2OD	LNA4802M3OD	LNA4802M4OD	LNA4832M2OD	LNA4832M3OD
	Blue	LNA4802AD	LNA4802M2AD	LNA4802M3AD	LNA4802M4AD	LNA4832M2AD	LNA4832M3AD
KRISTALL (polymer plastic)							
	London fog	LNA4802KF	LNA4802M2KF	LNA4802M3KF	LNA4802M4KF	LNA4832M2KF	LNA4832M3KF
	Aquamarine	LNA4802KA	LNA4802M2KA	LNA4802M3KA	LNA4802M4KA	LNA4832M2KA	LNA4832M3KA
	Cold grey	LNA4802KG	LNA4802M2KG	LNA4802M3KG	LNA4802M4KG	LNA4832M2KG	LNA4832M3KG
NEUTRAL (polymer plastic)							
	Anthracite	LNA4802AR	LNA4802M2AR	LNA4802M3AR	LNA4802M4AR	LNA4832M2AR	LNA4832M3AR
	White	LNA4802BI	LNA4802M2BI	LNA4802M3BI	LNA4802M4BI	LNA4832M2BI	LNA4832M3BI
	Tech	LNA4802TE	LNA4802M2TE	LNA4802M3TE	LNA4802M4TE	LNA4832M2TE	LNA4832M3TE
WOOD							
	Cherrywood	LNA4802LCA	LNA4802M2LCA	LNA4802M3LCA	LNA4802M4LCA	LNA4832M2LCA	LNA4832M3LCA
	Bamboo	LNA4802LBA	LNA4802M2LBA	LNA4802M3LBA	LNA4802M4LBA	LNA4832M2LBA	LNA4832M3LBA
	Walnut	LNA4802LNC	LNA4802M2LNC	LNA4802M3LNC	LNA4802M4LNC	LNA4832M2LNC	LNA4832M3LNC
SUPPORTS							
	Fixing with screws	LN4702M	LN4702M (x2)	LN4702M (x3)	LN4702M (x4)	LN4702 (x3)	LN4702 (x3)
	Fixing with clips	LN4702MG	LN4702MG (x2)	LN4702MG (x3)	LN4702MG (x4)	LN4702G (x3)	LN4702G (x3)

LIVINGLIGHT SQUARE COVER PLATES













- 2 MODULE AREA INSTALLATION SYSTEM

Cover plate finishing

METALS Material: zamak			
	Ice gold - OA	Bronze - BZ	
NATURALIA Material: zamak			
	Native - NA	Silver - AG	Brushed steel - ACS
SILK Material: zamak			
	Park - PK	Square - SQ	Brick - RK
			
	Avenue - AE	Club - CB	

SQUARE COVER PLATE CODES

- 2 modules - LNA4802...
- 2+2 modules - centre distance 71 mm - LNA4802M2...
- 2+2+2 modules - centre distance 71 mm - LNA4802M3...
- 2+2+2+2 modules - centre distance 71 mm - LNA4802M4...
- 2+2 modules - centre distance 57 mm - LNA4832M2...
- 2+2+2 modules - centre distance 57 mm LNA4832M3...

<p>DEEP Material: polymer plastic</p>			
	<p>Green - VD</p>	<p>Orange - OD</p>	<p>Blue - AD</p>
<p>KRISTALL Material: polymer plastic</p>			
	<p>London fog - KF</p>	<p>Acquamarine - KA</p>	<p>Cold grey - KG</p>
<p>NEUTRAL Material: polymer plastic</p>			
	<p>Anthracite - AR</p>	<p>White - BI</p>	<p>Tech - TE</p>
<p>ESSENCES Material: solid wood</p>			
	<p>Cherrywood - LCA</p>	<p>Bamboo - LBA</p>	<p>Walnut - LNC</p>

LIVINGLIGHT AIR - 3 MODULE AREA INSTALLATION SYSTEM

Cover plate installation

SELECTION TABLE

Flush mounted boxes	 503E (108x74x53.5 mm)	 504E (133x74x53.5 mm)	 506L (183.5x90x53.5 mm)	 506E (108x118x51.5 mm)
Plasterboard boxes	 PB503N (110x71x52 mm)	 PB504N (132.5x71x52 mm)	 PB506N (183x71x52 mm)	 PB526N (111x116x52 mm)
Supports	 LN4703C with screw	 LN4704C with screw	 LN4707C with screw	 LN4726C * with screw
No. of modules	 3 modules	 4 modules	 7 modules	 3+3 modules
AIR cover plates	 LNC4803...	 LNC4804...	 LNC4807...	 LNC4826...

NOTE: long screws 35 mm item 500/00 are available

 * supplied accessories in the colours of the product range

LIVINGLIGHT AIR - 3 MODULE AREA INSTALLATION SYSTEM

Table for selecting codes

Cover plate modules

		3	4	7	3+3
MONOCHROME (zamak)					
	Pure white	LNC4803BN	LNC4804BN	LNC4807BN	LNC4826BN
	Tech	LNC4803TE	LNC4804TE	LNC4807TE	LNC4826TE
	Anthracite	LNC4803AR	LNC4804AR	LNC4807AR	LNC4826AR
SOFT (zamak)					
	Street	LNC4803ST	LNC4804ST	LNC4807ST	LNC4826ST
	Clay	LNC4803CY	LNC4804CY	LNC4807CY	LNC4826CY
	Sand	LNC4803SB	LNC4804SB	LNC4807SB	LNC4826SB
	Blue moon	LNC4803BM	LNC4804BM	LNC4807BM	LNC4826BM
SHINY (zamak)					
	Pewter	LNC4803PT	LNC4804PT	LNC4807PT	LNC4826PT
	Palladium	LNC4803PL	LNC4804PL	LNC4807PL	LNC4826PL
	Satin gold	LNC4803OF	LNC4804OF	LNC4807OF	LNC4826OF
	Satin nickel	LNC4803NK	LNC4804NK	LNC4807NK	LNC4826NK
	Pearl white	LNC4803PR	LNC4804PR	LNC4807PR	LNC4826PR

Supports

Supports	LN4703C	LN4704C	LN4707C	LN4726C

LIVINGLIGHT AIR - 3 MODULE AREA INSTALLATION SYSTEM

Cover plate finishing

MONOCHROME

Material: zamak



Pure white - BN



Tech - TE



Anthracite - AR

SOFT

Material: zamak



Street - ST



Clay - CY



Sand - SB



Blue moon - BM

AIR COVER PLATE CODES

2 modules - LNC4802...

3 modules - LNC4803...

4 modules - LNC4804...

7 modules - LNC4807...

3+3 modules - LNC4826...

SHINY
Material: zamak



Pewter - PT



Palladium - PL



Satin gold - OF



Satin nickel - NK



Pearl white - PR

Customise your cover plate

SUGGESTIONS FOR USE.

The Livinglight Air cover plates PURE WHITE -BN- - can be painted by the customer.

PAINT

Before painting with house paint, the surface should be sanded/matted for better adhesion. Resin-rich products (e.g. water-based varnishes) should be used.

Notes

- The devices (keys, sockets, etc.) must not be painted
- paint the cover plate separately and fit once dry

COVER PLATE CLEANING

The use of water-based detergents is recommended. Using ethyl alcohol or other solvents which could damage or soften the paint is not recommended.

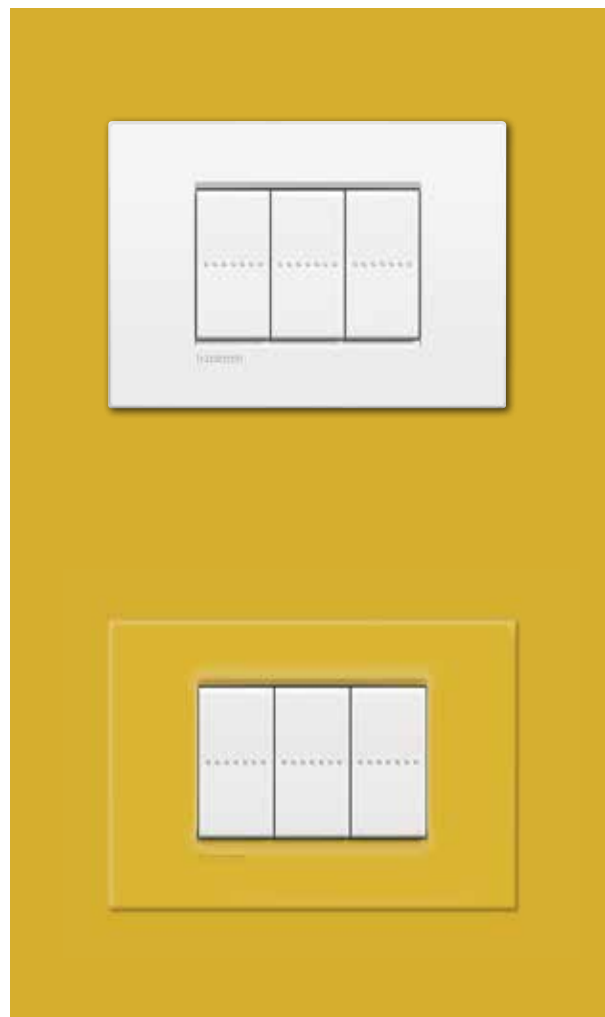





























For example: Livinglight Air cover plate
PURE WHITE - BN finish - painted

LIVINGLIGHT SQUARE COVER PLATES - 3 MODULE AREA INSTALLATION SYSTEM

Cover plate installation

SELECTION TABLE







Flush mounted boxes	 500 (Ø 60x44 mm)	 502E (70x70x50)	 503E (108x74x53.5 mm)	 504E (133x74x53.5 mm)	 506L (183.5x90x53.5 mm)	 506E (108x118x51.5 mm)
Plasterboard boxes		 PB502N (Ø 71x50.5 mm)	 PB503N (110x71x52 mm)	 PB504N (132.5x71x52 mm)	 PB506N (183x71x52 mm)	 PB526N (111x116x52 mm)
Supports	 LN4702G clip fastening	 LN4702 with screws	 LN4703 with screw	 LN4704 with screws	 LN4707 with screw	 LN4726* with screws
No. of modules	 2 modules	 2 modules	 3 modules	 4 modules	 7 modules	 3+3 modules
Square cover plates	 LNA4802..	 LNA4802..	 LNA4803...	 LNA4804...	 LNA4807...	 LNA4826...

NOTE: long screws 35 mm item 500/00 are available



* supplied accessories in the colours of the product range

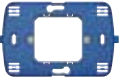
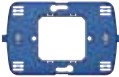











SELECTION TABLE (square cover plates with 2 centred modules)



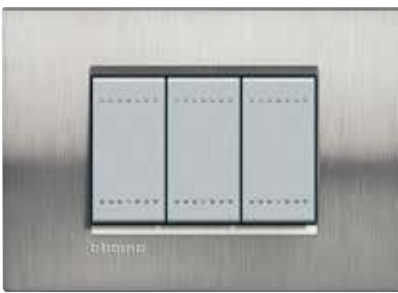









Flush mounted boxes	500 (Ø 60x44 mm) 	502E (70x70x50) 	503E (108x74x53.5 mm) 
Plasterboard boxes		PB502N (Ø 71x50.5 mm) 	PB503N (110x71x52 mm) 
Supports	LN4719G fastening with clips 	LN4719 with screws 	
No. of mod.	2 modules 		
Square cover plates	LNA4819.. 		

NOTE: long screws 35 mm item 500/00 are available

LIVINGLIGHT SQUARE COVER PLATES - 3 MODULE AREA INSTALLATION SYSTEM

Square cover plate finishing

























METALS Material: zamak	 <p>Ice gold - OA</p>	 <p>Bronze - BZ</p>	 <p>Steel - AC</p>
	 <p>Moonlight silver - GL</p>		
NATURALIA Material: zamak	 <p>Native - NA</p>	 <p>Silver - AG</p>	 <p>Brushed steel - ACS</p>
SILK Material: zamak	 <p>Park - PK</p>	 <p>Square - SQ</p>	 <p>Brick - RK</p>
	 <p>Avenue - AE</p>	 <p>Club - CB</p>	<p>CODES OF THE LIVINGLIGHT SQUARE COVER PLATES</p> <ul style="list-style-type: none"> 2 modules - LNA4802... 2 modules - LNA4819*... 3 modules - LNA4803... 4 modules - LNA4804... 7 modules - LNA4807... 3+3 modules - LNA4826... <p>* 2 centred modules for box 500, 502E, 503E, PB503N, PB502N</p>

<p>DEEP Material: techno polymer</p>			
<p>KRISTALL Material: techno polymer</p>			
<p>NEUTRAL Material: techno polymer</p>			
<p>WOODS Material: solid wood</p>			

LIVINGLIGHT SQUARE COVER PLATES - 3 MODULE AREA INSTALLATION SYSTEM

Table for selecting codes



Cover plate modules

		2	2 centred	3	4	7	3+3
METALS (zamak)							
	Ice gold	LNA4802OA	LNA4819OA	LNA4803OA	LNA4804OA	LNA4807OA	LNA4826OA
	Bronze	LNA4802BZ	LNA4819BZ	LNA4803BZ	LNA4804BZ	LNA4807BZ	LNA4826BZ
	Steel	LNA4802AC	LNA4819AC	LNA4803AC	LNA4804AC	LNA4807AC	LNA4826AC
	Moolight silver	LNA4802GL	LNA4819GL	LNA4803GL	LNA4804GL	LNA4807GL	LNA4826GL
NATURALIA (zamak)							
	Native	LNA4802NA	LNA4819NA	LNA4803NA	LNA4804NA	LNA4807NA	LNA4826NA
	Silver	LNA4802AG	LNA4819AG	LNA4803AG	LNA4804AG	LNA4807AG	LNA4826AG
	Brushed steel	LNA4802ACS	LNA4819ACS	LNA4803ACS	LNA4804ACS	LNA4807ACS	LNA4826ACS
SILK (zamak)							
	Park	LNA4802PK	LNA4819PK	LNA4803PK	LNA4804PK	LNA4807PK	LNA4826PK
	Square	LNA4802SQ	LNA4819SQ	LNA4803SQ	LNA4804SQ	LNA4807SQ	LNA4826SQ
	Brick	LNA4802RK	LNA4819RK	LNA4803RK	LNA4804RK	LNA4807RK	LNA4826RK
	Avenue	LNA4802AE	LNA4819AE	LNA4803AE	LNA4804AE	LNA4807AE	LNA4826AE
	Club	LNA4802CB	LNA4819CB	LNA4803CB	LNA4804CB	LNA4807CB	LNA4826CB
DEEP (polymer plastic)							
	Green	LNA4802VD	LNA4819VD	LNA4803VD	LNA4804VD	LNA4807VD	LNA4826VD
	Orange	LNA4802OD	LNA4819OD	LNA4803OD	LNA4804OD	LNA4807OD	LNA4826OD
	Blue	LNA4802AD	LNA4819AD	LNA4803AD	LNA4804AD	LNA4807AD	LNA4826AD
KRISTALL (polymer plastic)							
	London fog	LNA4802KF	LNA4819KF	LNA4803KF	LNA4804KF	LNA4807KF	LNA4826KF
	Aquamarine	LNA4802KA	LNA4819KA	LNA4803KA	LNA4804KA	LNA4807KA	LNA4826KA
	Cold grey	LNA4802KG	LNA4819KG	LNA4803KG	LNA4804KG	LNA4807KG	LNA4826KG
NEUTRAL (polymer plastic)							
	Anthracite	LNA4802AR	LNA4819AR	LNA4803AR	LNA4804AR	LNA4807AR	LNA4826AR
	White	LNA4802BI	LNA4819BI	LNA4803BI	LNA4804BI	LNA4807BI	LNA4826BI
	Tech	LNA4802TE	LNA4819TE	LNA4803TE	LNA4804TE	LNA4807TE	LNA4826TE
WOOD							
	Cherrywood	LNA4802LCA	LNA4819LCA	LNA4803LCA	LNA4804LCA	LNA4807LCA	LNA4826LCA
	Bamboo	LNA4802LBA	LNA4819LBA	LNA4803LBA	LNA4804LBA	LNA4807LBA	LNA4826LBA
	Walnut	LNA4802LNC	LNA4819LNC	LNA4803LNC	LNA4804LNC	LNA4807LNC	LNA4826LNC
Supports							
	Fixing with screws	LN4702	LN4719	LN4703	LN4704	LN4707	LN4726
	Fixing with clips	LN4702G	LN4719G				







CUSTOMISABLE SWITCHES

When created using tilting control devices, the light point may be customised using transparent key covers and a transparent cover plate. The cover plate, available in 3, 4, 7, and 3+3 module versions, has a removable under plate that can be removed and interleaved with wallpaper, so that it will not stand out from the wall, or using a favourite pattern or photo, to achieve the opposite effect. The same can be done with the 1, 2 or 3 module key covers.





ITEMS FOR THE CUSTOMISATION OF THE LIGHT POINT

Item	Customisable transparent key cover for rocker control devices	
○ N4932		1 module
○ N4932/2		2 modules
○ N4932/3		3 modules

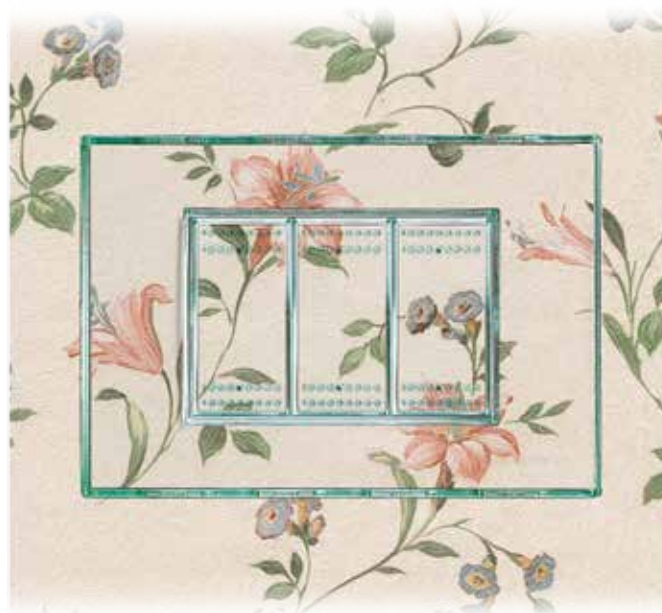
Customisable transparent cover plates

○ LND4802KR		2 modules
○ LND4819KR		2 centred modules (LN4719 or LN4719G)
○ LND4803KR		3 modules
○ LND4804KR		4 modules
○ LND4807KR		7 modules
○ LND4826KR		3 + 3 modules



○ LND4802M2KR		2 + 2 modules centre distance 71mm
○ LND4802M3KR		2 + 2 + 2 modules centre distance 71mm
○ LND4832M2KR		2 + 2 modules centre distance 57mm
○ LND4832M3KR		2 + 2 + 2 modules centre distance 57 mm

COVER PLATE CUSTOMISATION

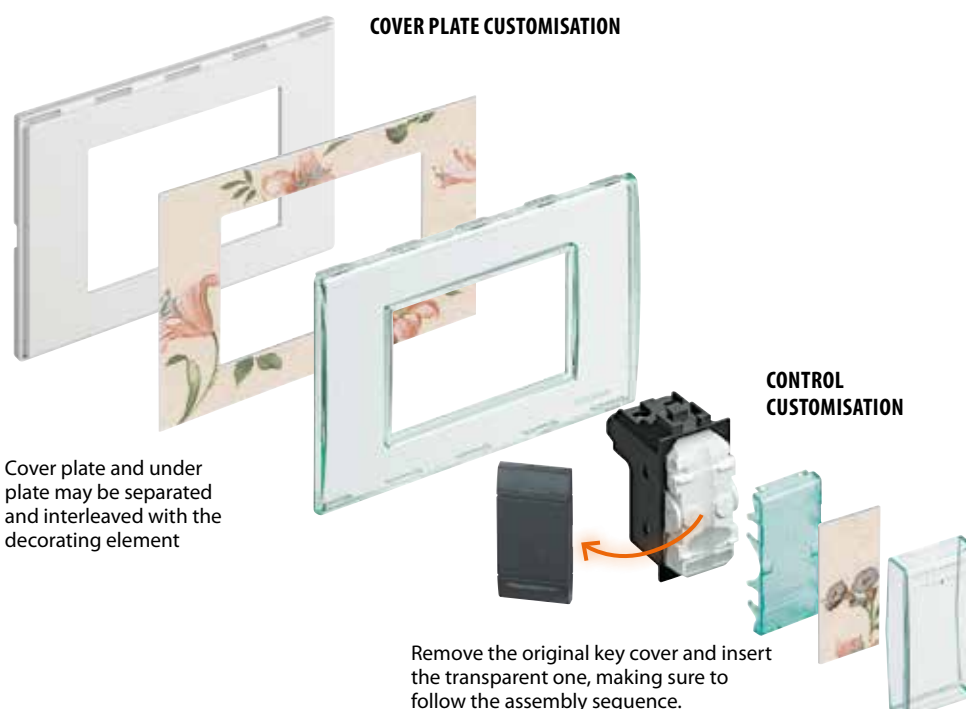













Cover plate and under plate may be separated and interleaved with the decorating element

CONTROL CUSTOMISATION

Remove the original key cover and insert the transparent one, making sure to follow the assembly sequence.

INSTALLATION IN WALL-MOUNTED BOXES

Boxes	Modules	Cover plates
 <p>502BI (white)</p>	 <p>2 modules</p>	 <p>LNA4802...</p>  <p>LNC4802...</p>
 <p>503BI (white)</p>	 <p>3 modules</p>	 <p>LNA4803...</p>  <p>LNC4803...</p>
 <p>504BI (white)</p>	 <p>4 modules</p>	 <p>LNA4804...</p>  <p>LNC4804...</p>
 <p>150418BA with supports and cover plates (173x247x65) (white)</p>  <p>150418GR - with supports and cover plates (173x247x65) (anthracite)</p>	 <p>3 x 6 modules</p>	
 <p>506NP (118x118x55) (white)</p>  <p>N4070 indoor siren N4565 loudspeaker (white)</p>	 <p>506NP (118x118x55) (white)</p>  <p>NT4070 indoor siren NT4565 loudspeaker (tech)</p>	 <p>506LP (118x118x55) (anthracite)</p>  <p>4070 indoor siren L4565 loudspeaker (anthracite)</p>

OTHER INSTALLATIONS

INSTALLATION ON RAILS

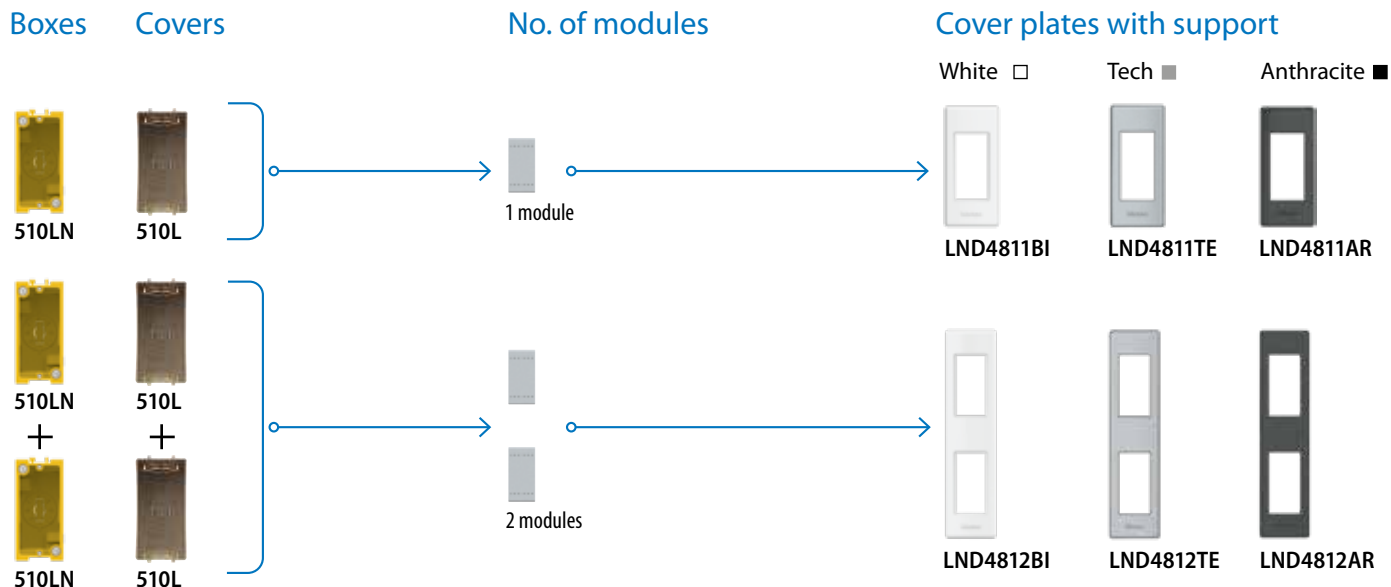

Item 510LN: box that can be used also for plasterboard and masonry walls
Art. 510L: accessory cover for installation on rails

INSTALLATION IN MULTIBOX BOXES

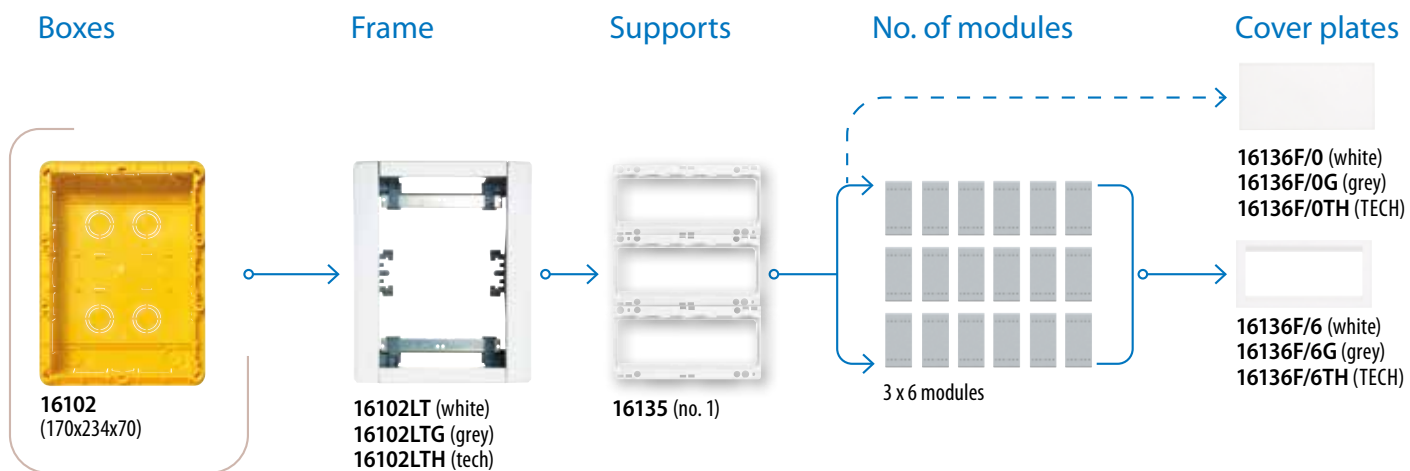
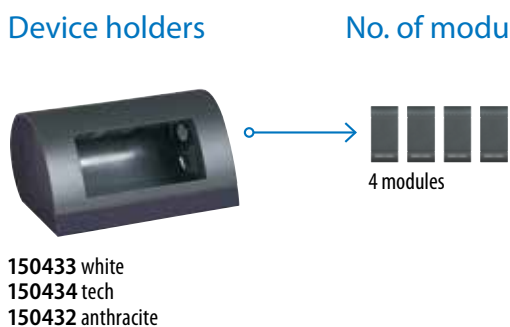
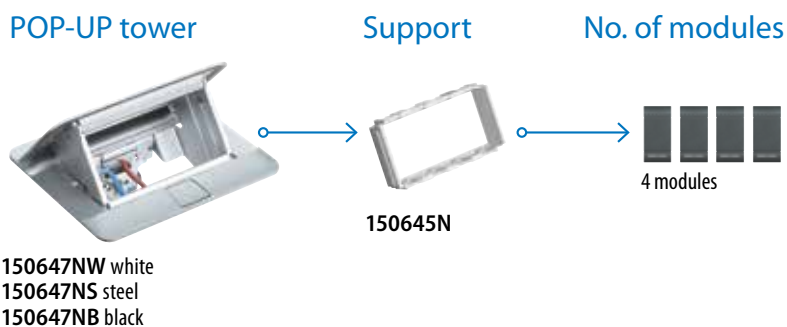

TABLE-TOP INSTALLATION













POP-UP TOWERS

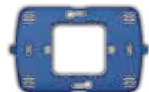















INSTALLATION IN FLUSH-MOUNTED BOX WITH PROTECTED COVERS







UNIVERSAL COVER SELECTION TABLE

Flush mounted boxes	 503E (108x74x53.5 mm)		
Plasterboard boxes	 PB503N (110x71x52 mm)		
IP44 - IDROBOX universal cover	 26603		
Supports	 LN4703C with screws	 LN4703 with screw	 LN4719 with screws
No. of modules	 3 modules	 3 modules	 2 modules
Cover plates	 LNC4803.../LNA4803...	 LNA4803...	 LNA4819...

SELECTION TABLE FOR 2 OR 3 MODULES

Flush mounted boxes	 502E (70x70x50)			 503E (108x74x53.5 mm)		
No. of modules	 2 modules	 2 modules	 2 modules	 3 modules	 3 modules	 3 modules
Cover plates	 24602N - white	 24602 RAL7035 grey	 24602L anthracite	 24603N - white	 24603 - RAL7035 grey	 24603L - anthracite

SELECTION TABLE FOR 4 MODULES

Flush mounted boxes	 504E (133x74x53.5 mm)		
No. of modules	 4 modules	 4 modules	 4 modules
Cover plates	 24604N - white	 24604 - RAL7035 grey	 24604L - anthracite

NOTE: The IP55 protection index of the covers for item 502E, 503E, 504E is obtained with the cover closed and the item installed on smooth walls, without grooves and waterproof (smooth tiles, marble).

INSTALLATION IN PROTECTED HOUSING

IP40 AND IP55 IDROBOX PROTECTED COVERS

IP40 housings

1 module
IP40



24401

2 modules
IP40



24402

3 modules
IP40



24403

4 modules
IP40



24404

IP40 housings

4 modules
IP40



24404/2

6 modules
IP40



24406

IP55 housings

1 module
IP55



24501

2 modules
IP55



24502

3 modules
IP55



24503







4 modules
IP55

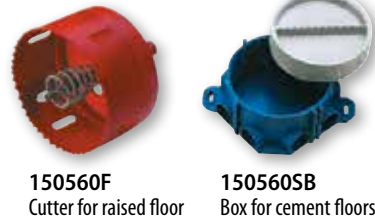





24504

INSTALLATION IN PROTECTED HOUSINGS AND OTHER



Item	ACCESSORIES FOR IP40 - IP55 HOUSINGS	
○ 25700		flexible cable entry gland Ø 5 to 14-16-20 mm – IP55
○ 25700F/16		quick-coupling pipe gland IP55 for pipes Ø 16 mm
○ 25700F/20		quick-coupling pipe gland IP55 for pipes Ø 20 mm
○ 25701		horizontal partition
○ 25701V		vertical partition
○ 25702		internal terminal for earth connection

Item	WIRING ACCESSORIES - FLOOR BOXES	
		<p>These floor boxes were planned for being equipped with 1 or 2 module devices of the wiring accessories series LIVINGLIGHT.</p> <p>Thanks to the cover with automatic shutting and hinge made of caoutchouc, they allow a very good protection degree (IP24-7).</p> <p>There are two finishes that can be stepped on: inox steel and brass, both of them particularly polished and which can carry a max. split up weight of 500 kg.</p> <p>By means of two specific boxes, the installation can be made in cement floors (with a min. depth of 50 mm) or in raised technical floors (with a min. depth of 60 mm).</p> <p>Dimensions:</p> <ul style="list-style-type: none"> – ext. diameter 100 mm – protrusion from the floor max. 4.5 mm
○ 150560AC		2 module column, inox
○ 150560OT		2 module column, brass
○ 150560SB		box for cement
○ 150560S		underfloor flush mounted box
○ 150560F		cutter diam. 86 mm

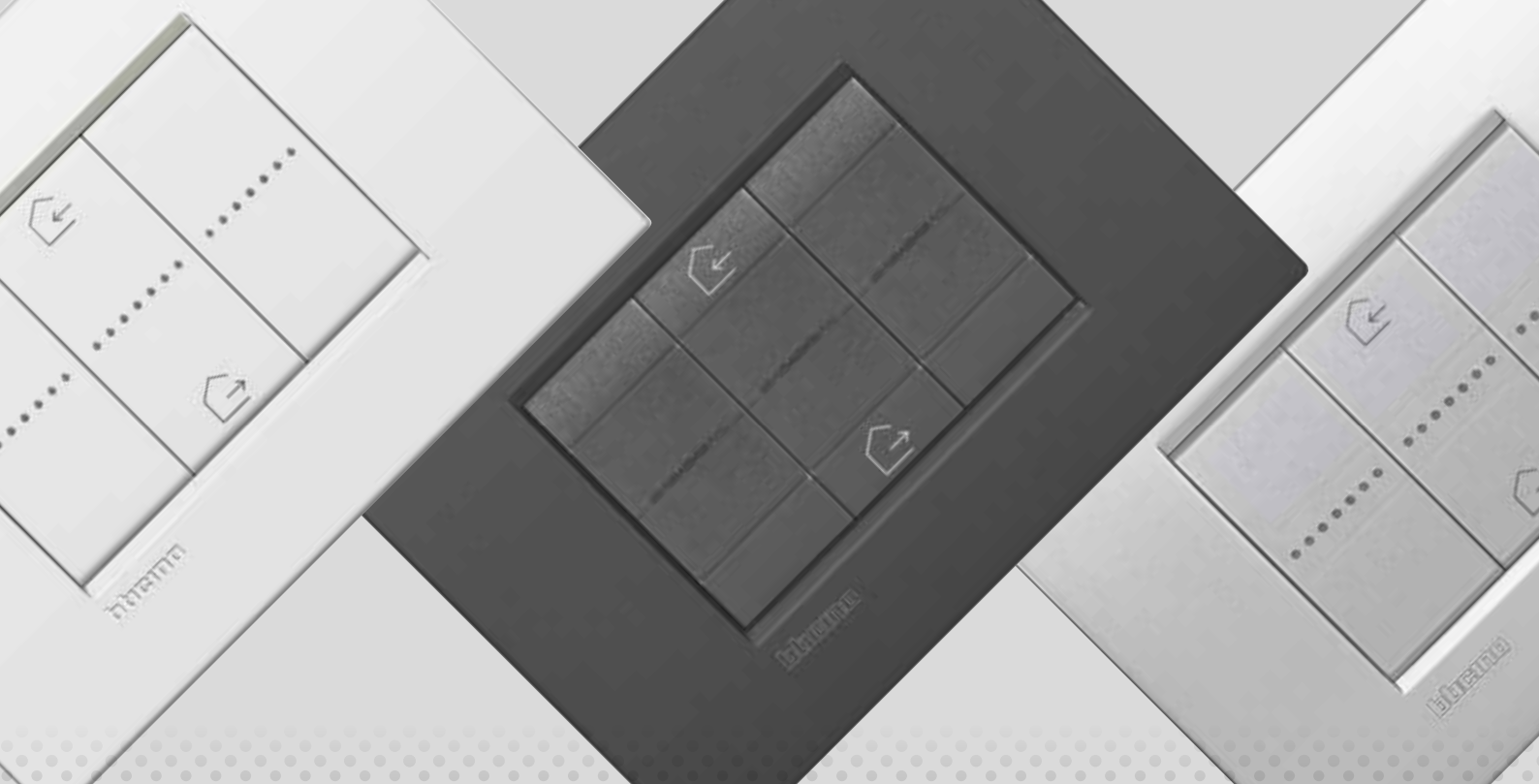

TECHNICAL INFORMATION DIMENSIONAL DATA

TECHNICAL INFORMATION

Dimmer

UNIVERSAL DIMMER: ELECTRICAL CONNECTIONS

Stand alone dimmer

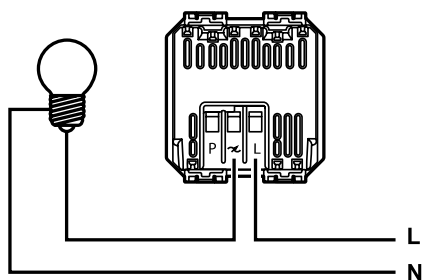

Dimmer with remote pushbuttons

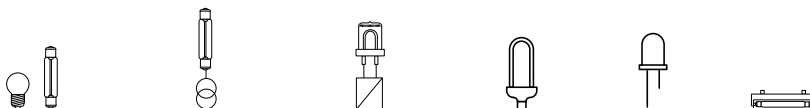
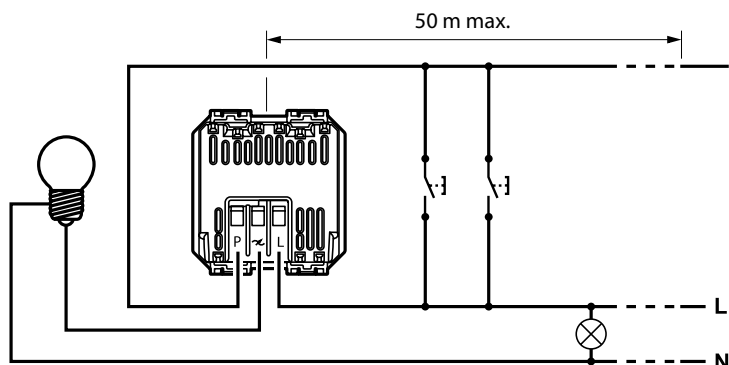

Loads

Item	Type	range	supply std	Incandescents and halogens	Halogens with ferromagnetic transformer	Halogens with electronic transformer	Dimmable compact fluorescents	Dimmable LED lamps	Fluorescents with electronic 0-10 V ballast
N4402N NT4402N L4402N	Resistive	230 Va.c. 50 Hz	230 Va.c.	60 - 500 W					
N4406 NT4406 L4406	Resistive	230 Va.c. 50 - 60 Hz	230 Va.c.	100 - 500 W					
N4408N NT4408N L4408N	Resistive Inductive	100 - 240 Va.c. 50 - 60 Hz	240 Va.c. 100 Va.c.	20 - 600 W 20 - 300 W	20 - 600 VA 20 - 300 VA				
N4410N NT4410N L4410N	0 - 10 V	100 - 240 Va.c. 50 - 60 Hz	240 Va.c. 100 Va.c.						20 - 600 VA 20 - 300 VA
N4411N NT4411N L4411N	Universal	100÷240 Va.c. 50÷60 Hz	240 Va.c. 100 Va.c.	3 ÷ 400 W 3 ÷ 200 W	3 ÷ 400 VA 3 ÷ 200 VA	3 ÷ 400 VA 3 ÷ 200 VA	3 - 150 VA 3 - 75 VA	3 - 150 VA 3 - 75 VA	
N4581 NT4581 L4581	Resistive	110 - 230 Va.c. 50 - 60 Hz	230 Va.c. 127 Va.c.	50 - 800 W 50 - 400 W					
N4582N NT4582N L4582N	Resistive Capacitive	110 - 230 Va.c. 50 - 60 Hz	127 Va.c. 230 Va.c.	50 - 400 W 50 - 700 W	50 - 400 W 50 - 700 W		50 - 300 W 50 - 300 W		100 - 300 W 100 - 500 W

Thermostat

ITEM L/N/NT4451

Technical data

- operating temperature: 5 - 35°C;
- power supply: 2 x 1.5V alkaline batteries type LR6/AA;
- minimum time between one scheduled intervention and the next: 15 minutes;
- selectable temperature values: 3 - 40° C (with a minimum interval of 0.1° C);
- accuracy of controlled temperature: $\pm 0.5^\circ\text{C}$;
- battery life: not less than one year;
- recessed installation;
- voltage free output contacts, maximum load: 5 (3)A;
- terminals for connecting an external temperature probe with the following characteristics: R (25 ° C) = 10k BETA = 3435 - max. length of the connection: 5 meters;
- possibility of remote activation through remote control (e.g. telephone switchboard, telephone actuator, system burglar alarm etc.).

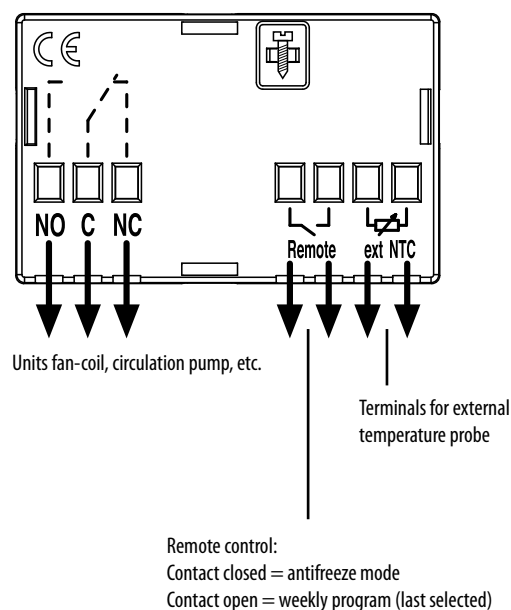

ITEM L/N/NT4442

Technical data

- power supply: 230 Vac $\pm 10\%$ 50/60 Hz 0,6W;
- maximum load output NO contacts: 2A $\cos\phi$ 1 - 0.5;
- room temperature adjustment range: 5 - 30°C;
- accuracy: 0.5°C;
- recommended installation: 1.5m from the ground (away from heat sources and air currents). Do not install in boxes where there are dimmers;
- electrical connection by means of terminals for cables: max \varnothing 2.5 mm²;
- for heating and air conditioning systems: boilers, fan-coil units, air conditioners, fan coils;
- with "summer / winter" switch.

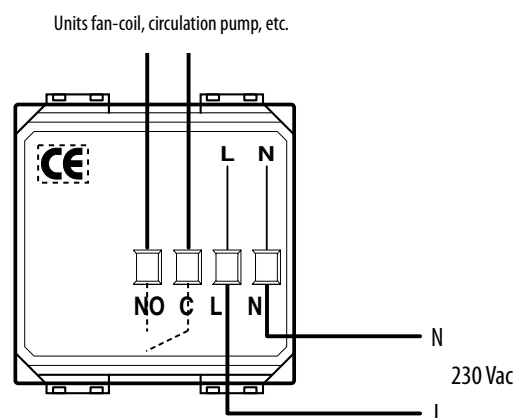

TECHNICAL INFORMATION

Devices for the Smart electrical system

TECHNICAL FEATURES FOR ALL DEVICES

- Technology: ZigBee certified product, Zigbee 3.0 public profile
- Performance: 200 m range in a free point-to-point field
- Band frequency: from 2.4 to 2.4835 GHz

CONNECTED TWO-WAY SWITCH ITEM L/N/NT4003C

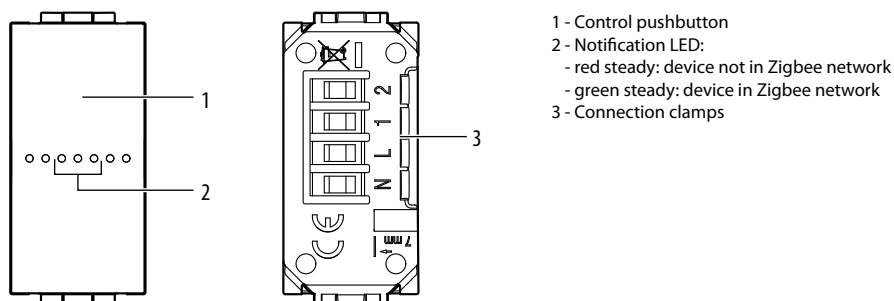

Three-point lighting control with connected two-way switch item L/N/NT4003C in place of a traditional wo-way switch.

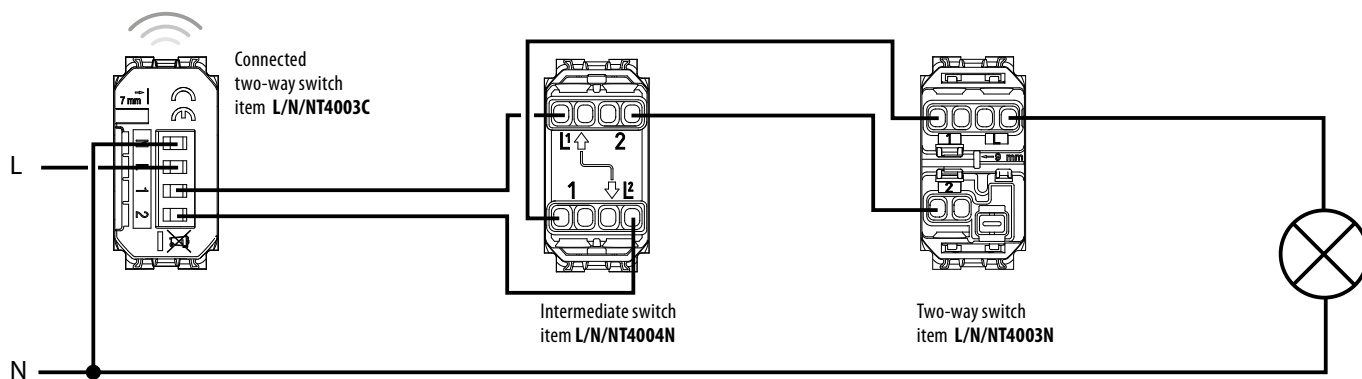

CONNECTED DIMMER ITEM L/N/NT4411C

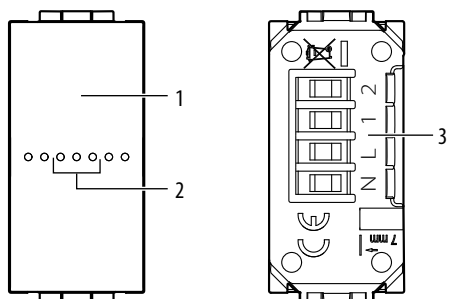

- 1 - Control pushbutton
- 2 - Notification LED:
 - red steady: device not in Zigbee network
 - green steady: device in Zigbee network
- 3 - Connection clamps

Basic diagram

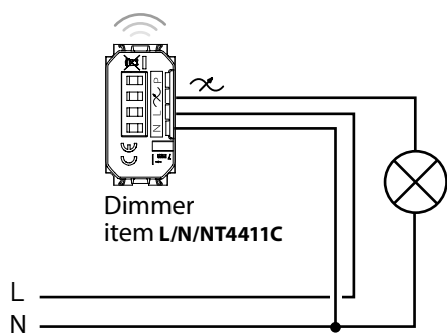
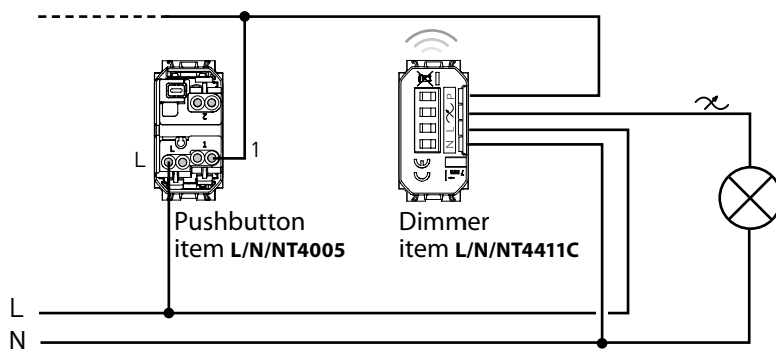

Diagram with remote control pushbuttons



Technical features

 110 – 240 V~, 50/60 Hz		LED
Loads	Filament lamp or halogen lamp	LED lamp
240 VAC	150 W	150 W
100 VAC	75 W	75 W
Technology	Radio (Wireless meshed network)	
Power level	< 100 mW	
Band frequency	from 2,4 to 2,4835 GHz	

TECHNICAL INFORMATION

Devices for the Smart electrical system

SHUTTERS CONTROL ITEM L/N/NT4027C AND MICROMODULE ITEM 4027C

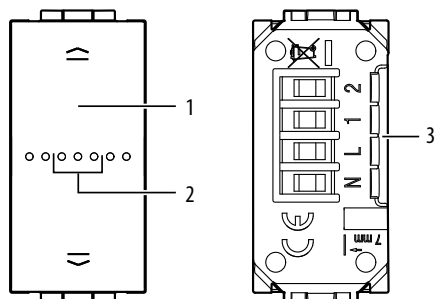

item L/N/NT4027C

- 1 - Control pushbutton
- 2 - Notification LED
- 3 - Connection clamps

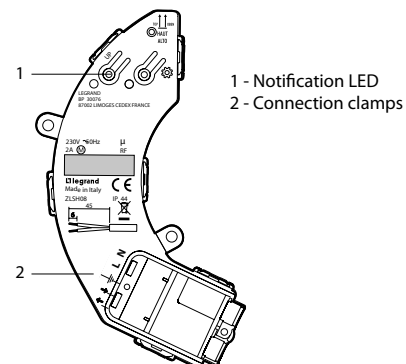

item 4027C

Wiring diagram

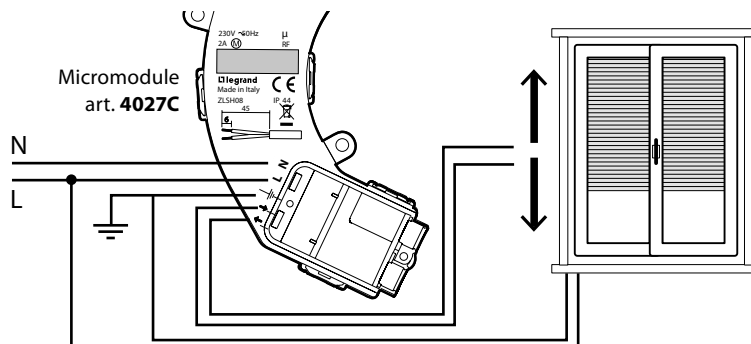
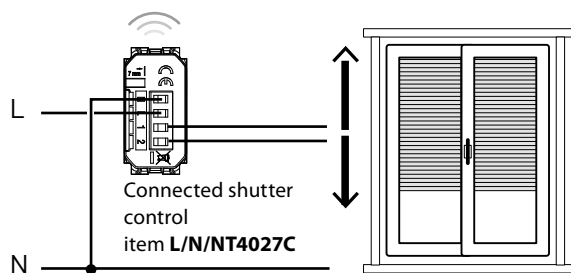

Warning: only compatible with standard motors
(no pulse motors, no radio motors)

Technical features

110 – 240 V~, 50/60 Hz



Carichi	Motor for shutters
240 VAC	1 x 500 VA
100 VAC	1 x 270 VA
Technology	Radio (Wireless meshed network)
Power level	< 100 mW
Band frequency	from 2,4 to 2,4835 GHz

CONNECTED DIN METER ITEM F20T60A AND ITEM F80GCS

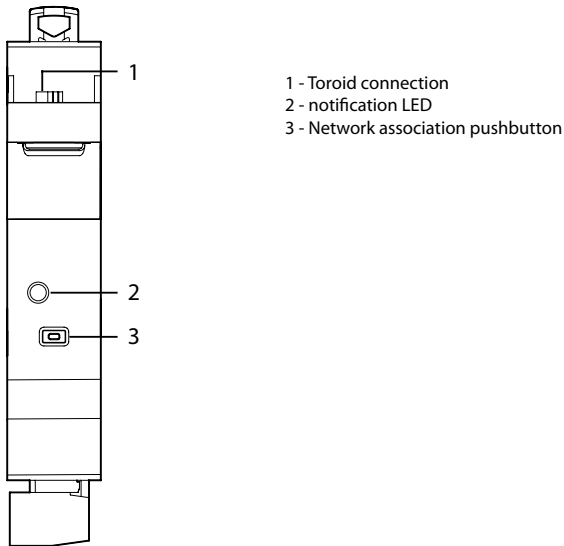

Wiring diagram

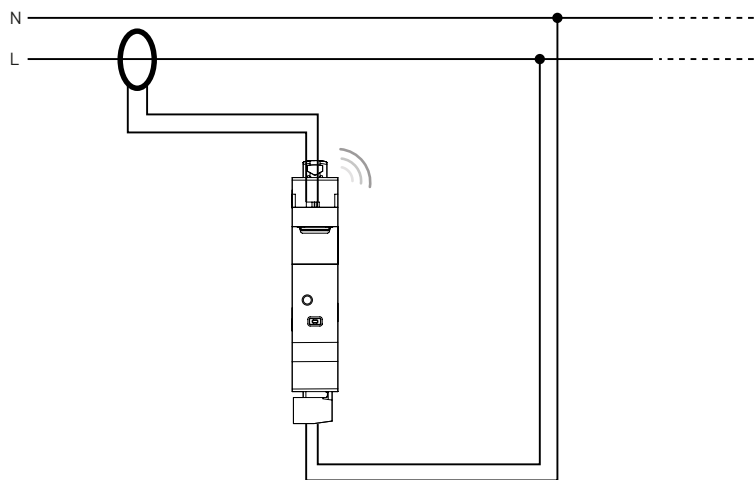

Technical features

Voltage	100/240 V~
Maximum current measured (coil)	72 A
Frequency	50/60 Hz
Power level	< 100mW
Stand-by current	1 mA

TECHNICAL INFORMATION

Devices for the Smart electrical system

CONNECTED LIGHT RELAY ITEM 3584C

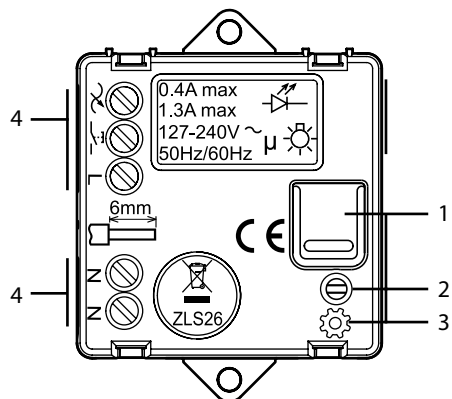

- 1 - Control pushbutton
- 2 - Setting pushbutton
- 3 - Notification LED
 - red steady: device not in Zigbee network
 - green steady: device in Zigbee network
- 4 - Connection clamps

Three-point lighting control with buttons and connected relays item 3584C installed in place of a traditional relay

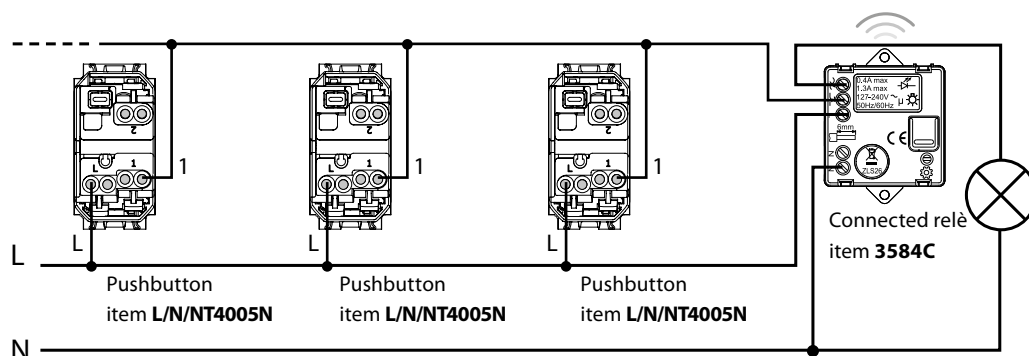

Table of managed loads

		R			L	
Loads 240 V ~ 50/60 Hz	Max.	Filament lamp or halogen lamp 300 W	LED lamp (*) 100 W	Fluorescent compact 250 VA	Electronic transformer 250 VA	Ferromagnetic transformer (**) 250 VA

* or 10 maxi lamps

** **warning:** ferromagnetic transformers must be charged at over 60% of their rated power.

CONNECTED MODULE FOR SOCKET ITEM L/N/NT4531C

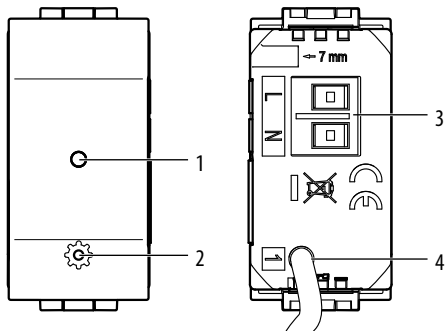

- 1 - notification LED
- red steady: device not in Zigbee network
- green steady: device in Zigbee network
- 2 - Setting pushbutton
- 3 - Connection clamps
- 4 - load controlled phase cable

Wiring diagram

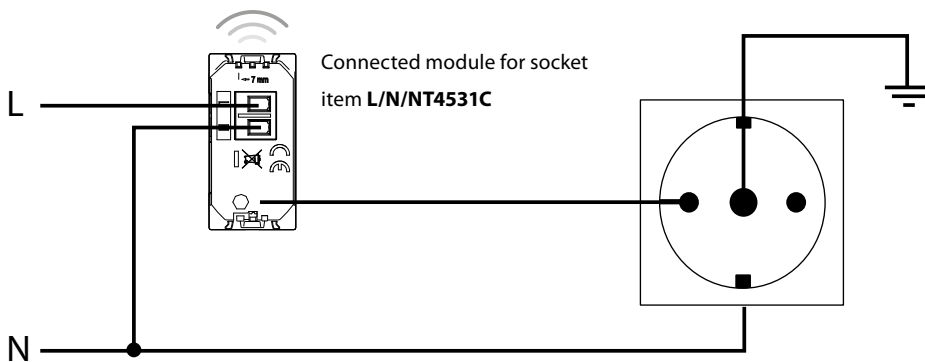

Table of managed loads

+45°C +5°C 2 x 2,5mm ²								
Loads	Filament lamp	Halogen lamp	Electronic transformer	Ferromagnetic transformer	Fluorescent tube	Fluorescent compact	LED lamp	Ventilation motor
230 Va.c. 3800 W cosφ 0,8	16 A							

TECHNICAL INFORMATION

Devices for the Smart electrical system

CONNECTED DIN RELÈ ITEM FC80RC

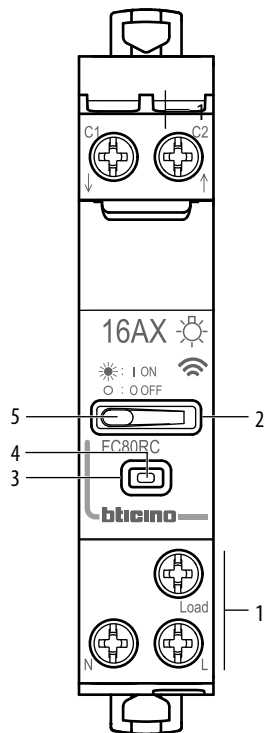

1. Connection clamps
2. Control pushbutton
3. Notification LED
Red: not associated to the system
Off: associated to the system
4. Reset push button
5. Load status LED
Green: closed contact
Off: open contact

Diagram with control pushbuttons without voltage

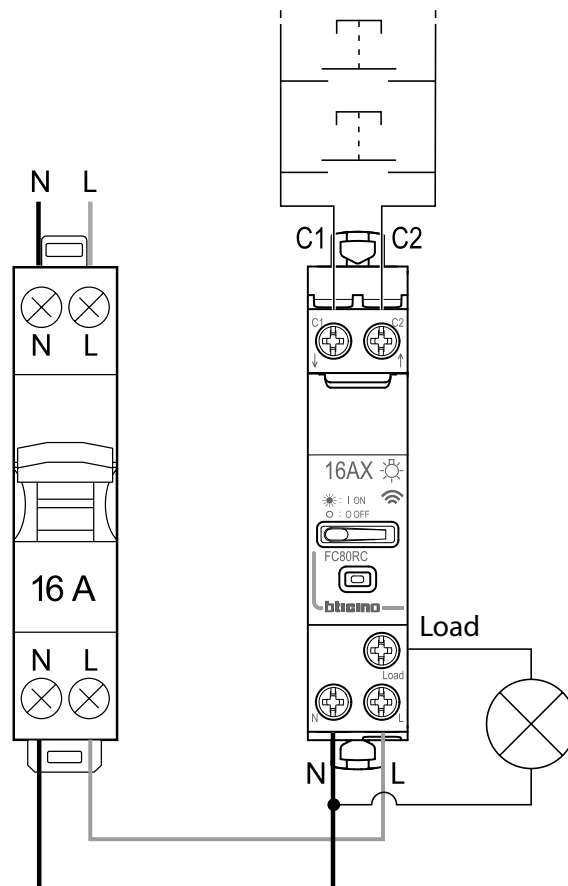



Table of managed loads

	 + 45 °C - 5 °C		 <table border="1" style="display: inline-table; border-collapse: collapse;"> <thead> <tr> <th colspan="2">N, L, LOAD</th> <th colspan="2">C1, C2</th> </tr> </thead> <tbody> <tr> <td>2 x 2,5 mm²</td> <td>1 x 6 mm²</td> <td>2 x 1,5 mm²</td> <td>1 x 2,5 mm²</td> </tr> </tbody> </table>				N, L, LOAD		C1, C2		2 x 2,5 mm ²	1 x 6 mm ²	2 x 1,5 mm ²	1 x 2,5 mm ²
	N, L, LOAD		C1, C2											
2 x 2,5 mm ²	1 x 6 mm ²	2 x 1,5 mm ²	1 x 2,5 mm ²											
Loads	Filament lamp or halogen lamp	LED lamp*	Fluorescent compact	Electronic transformer	Ferromagnetic transformer **									
Power	3840 W	650 W	650 VA	3000 VA	3000 VA									
Voltage	240 Vac													
Operating frequency	50 Hz													
Technology Radio	Wireless meshed network													
Power level	<100mW													
Band frequency	from 2,4 to 2,4835 GHz													
Power dissipation	<0,4W without load / <1,7W with load													
Sound emission	<10dB													
Dimensional data	1 module DIN													

(*) Or 10 maxi. lamps For good lighting comfort, we recommend the use of lamps of the same type and from the same supplier.

(**) Caution: - Ferromagnetic transformers must be charged at over 60% of their rated power.

- During the calculation of the permitted power, take into account the performance of ferromagnetic transformers.

- A load must be connected before programming and using the product.

- Use only with transformers designed to work with electronic switches.

CONNECTED CONTACTOR ITEM FC80CC

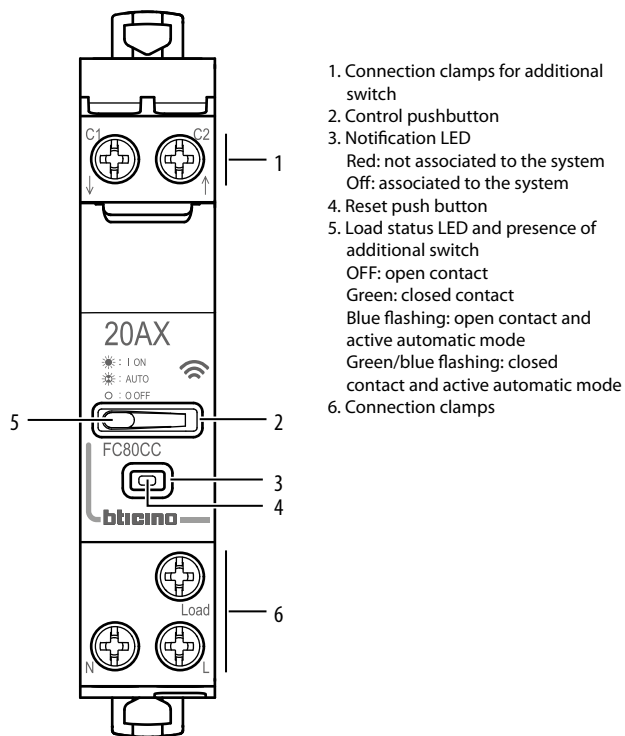
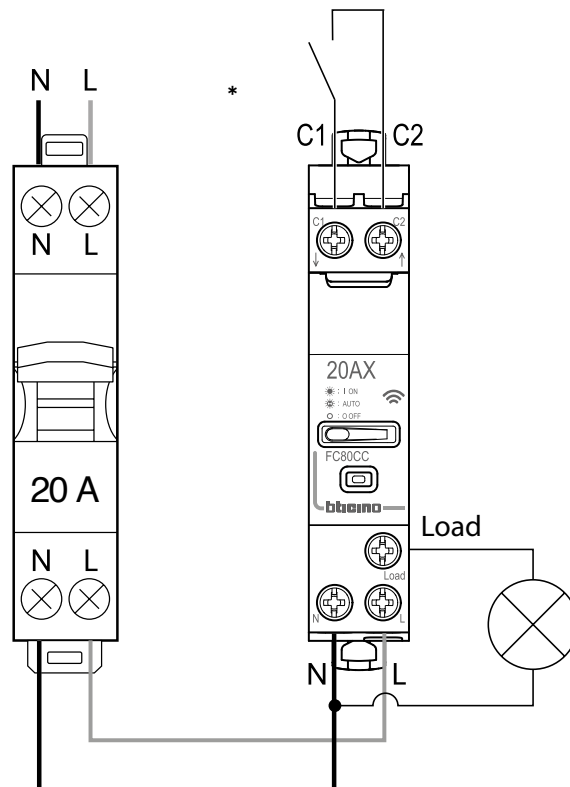

Diagram with control pushbuttons without voltage



*: the control from an additional switch takes priority over the other operating modes.

Table of managed loads

+ 45 °C - 5 °C	N, L, LOAD 2 x 2,5 mm ² 1 x 6 mm ²		C1, C2 2 x 1,5 mm ² 1 x 2,5 mm ²	
Loads	Resistive loads	Motor		
Power	4800 W	2400 VA		
Voltage	240 Vac			
Operating frequency	50 Hz			
Technology Radio	Wireless meshed network			
Power level	<100mW			
Band frequency	from 2,4 to 2,4835 GHz			
Power dissipation	<0,4W without load / <1,7W with load			
Sound emission	<10dB			
Dimensional data	1 module DIN			

TECHNICAL INFORMATION

Devices for the Smart electrical system

SMARTHER2 ITEM XW/XM/XG8002

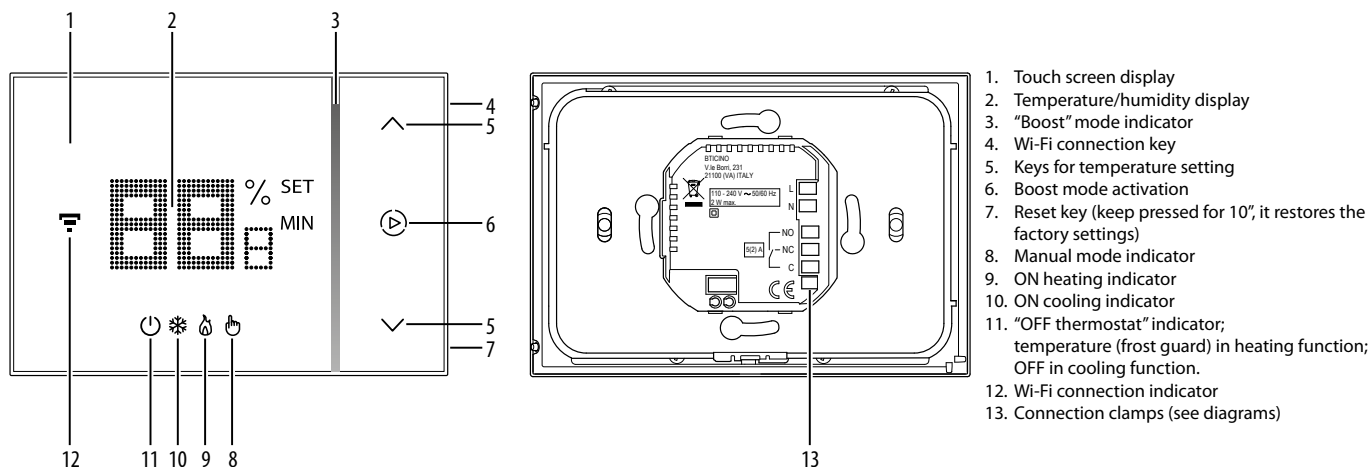

Wiring diagrams

System only for heating with clean contact (e.g. boiler agreement)

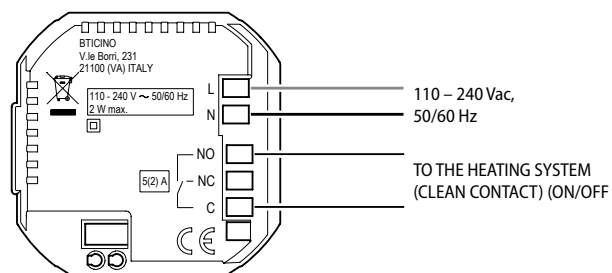

System only for heating with load to be controlled to the network voltage (e.g. 230Vac solenoid valve)

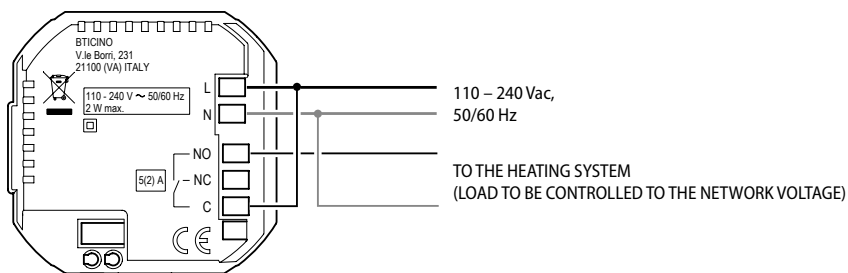

For other diagrams, consult the documentation supplied with the device.

DIMENSIONAL DATA

LIVINGLIGHT square cover plates

SQUARE COVER PLATES

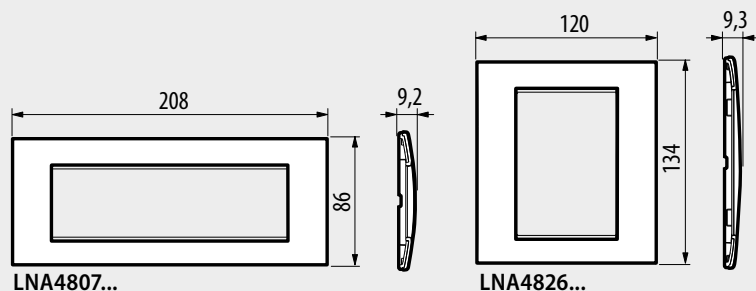
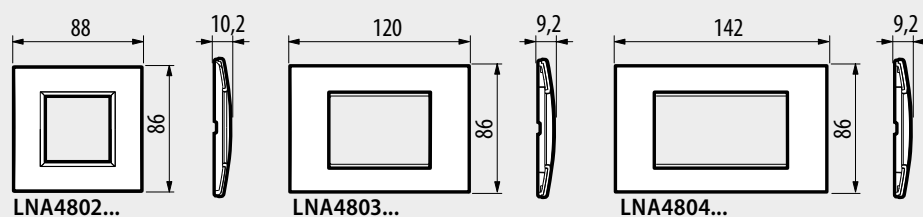

CENTRE DISTANCE 57 mm - HORIZONTAL/VERTICAL

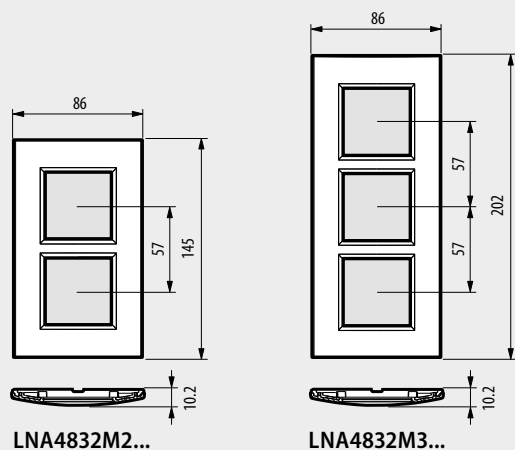

CENTRE DISTANCE 71 mm - HORIZONTAL/VERTICAL

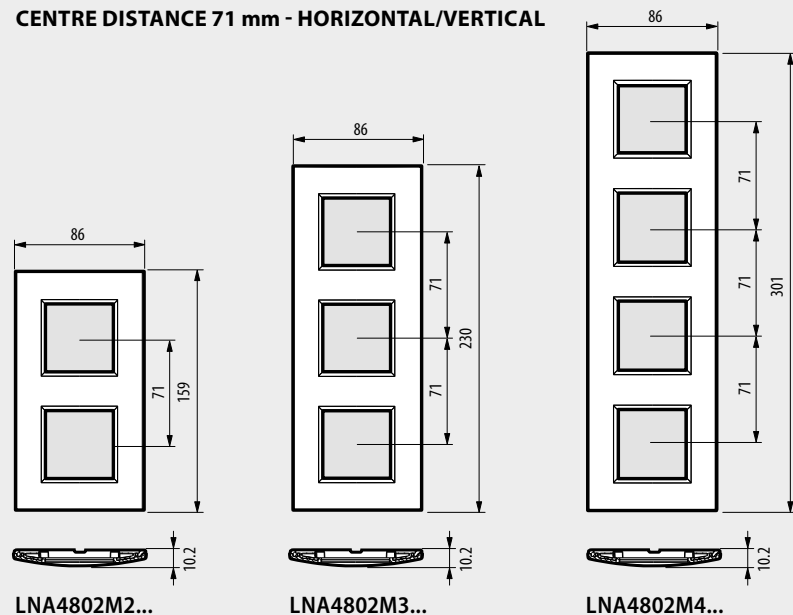

DIMENSIONAL DATA

LIVINGLIGHT AIR cover plates

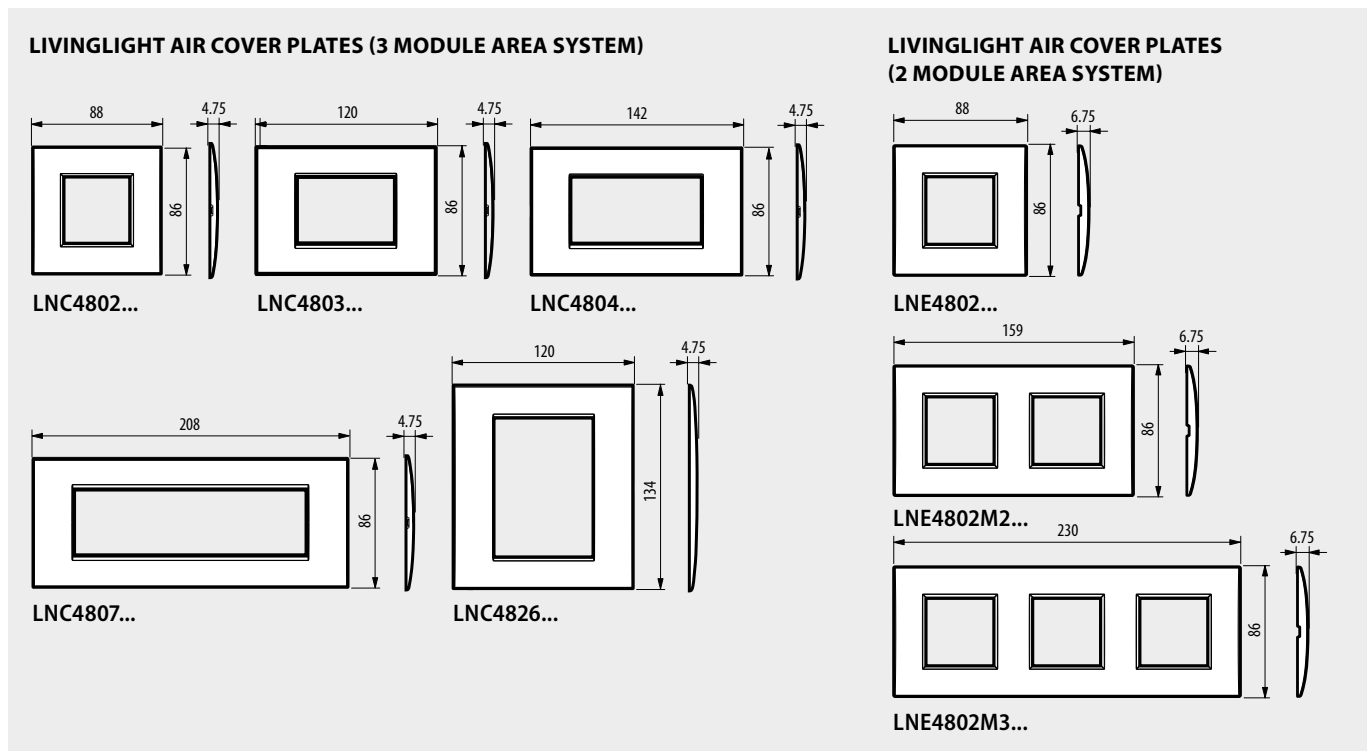

Box and cover plates for rails

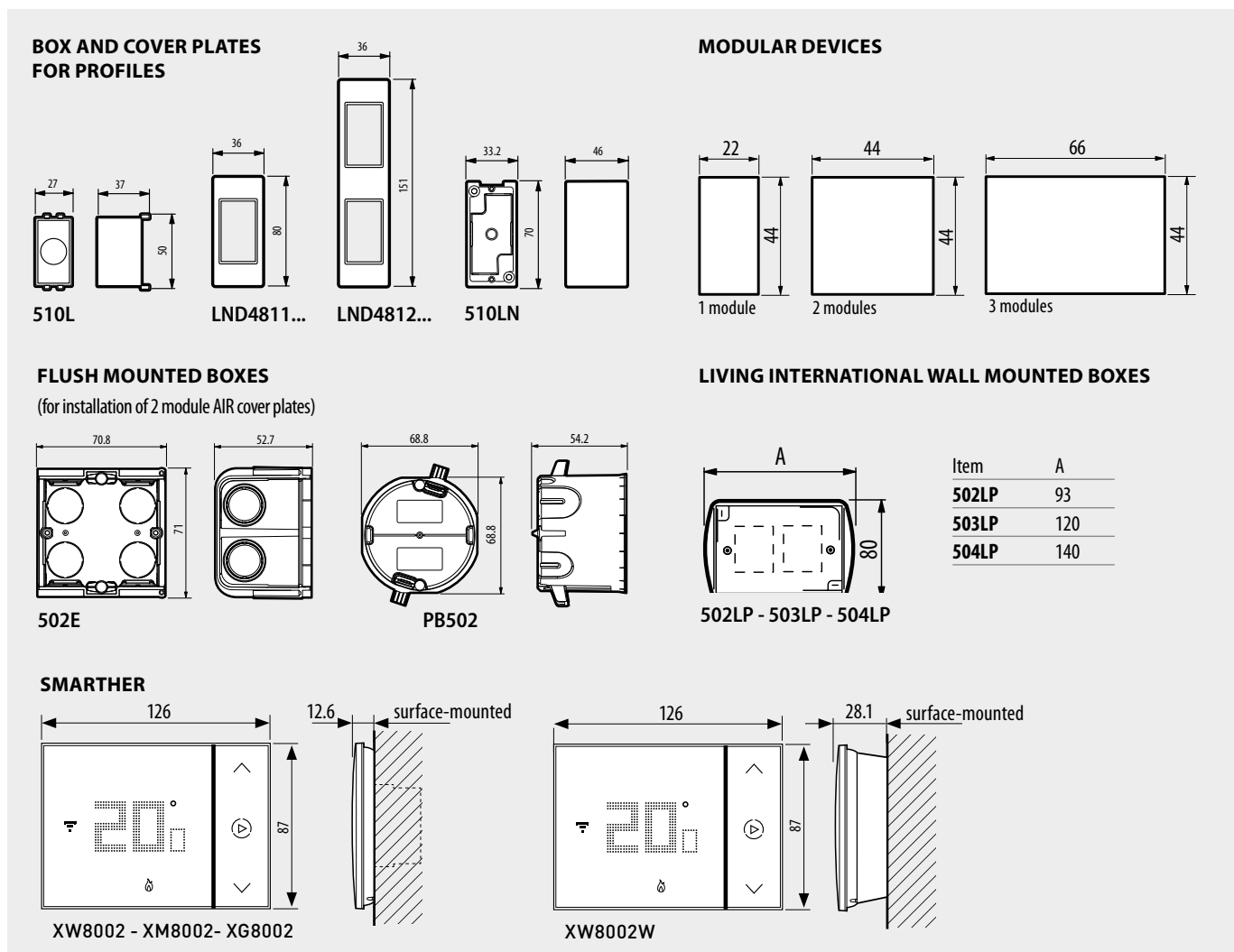

DIMENSIONAL DATA

Livinglight AIR supports

3-MODULE SUPPORT

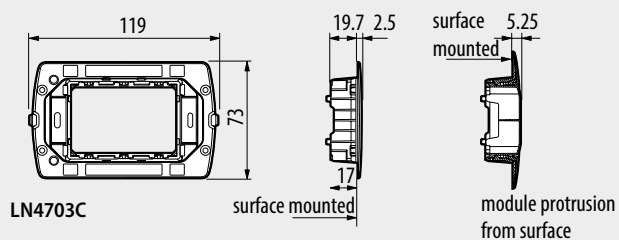

4-MODULE SUPPORT

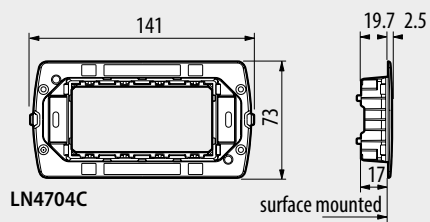

7-MODULE SUPPORT

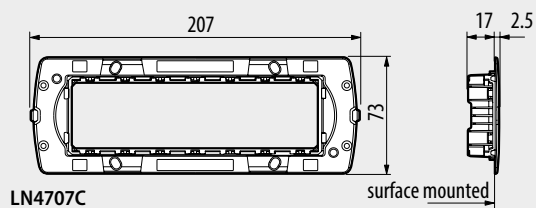

3+3-MODULE SUPPORT

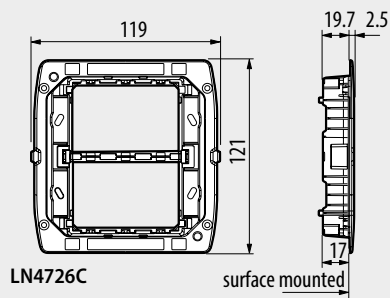

2-MODULE SUPPORT

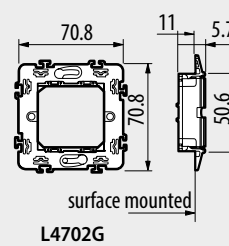
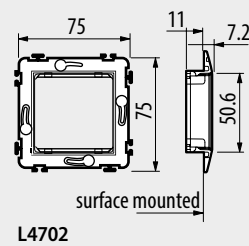
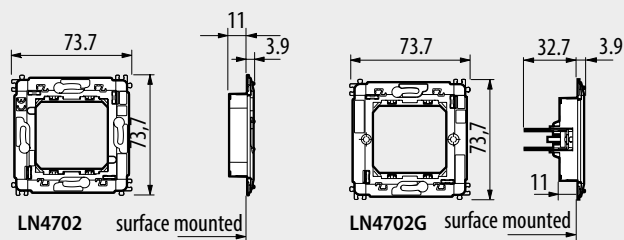

3-MODULE SUPPORT

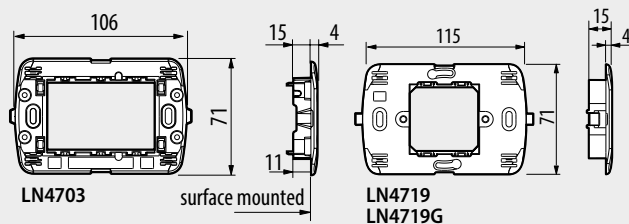

4-MODULE SUPPORT

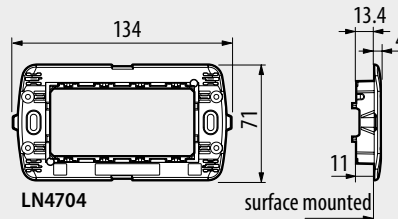

7-MODULE SUPPORT

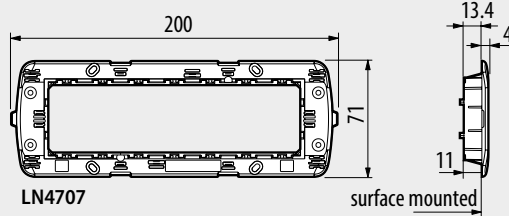

3+3-MODULE SUPPORT

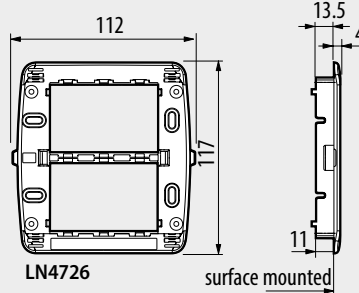

BTicino SpA
Viale Borri, 231
21100 Varese - Italy
www.bticino.com

BTicino S.p.A. reserves at any time the right to modify the contents of this booklet and to communicate, in any form and modality, the changes brought to the same.

AD-EXLL2M23C/GB - Edition 03/2023