

Classe 100

NOW THE STANDARD
IS CONNECTED



bticino

A Group brand | **legrand**

Classe 100

Video internal units



Classe 100X16E
with Netatmo

**THE CONNECTED
SOLUTION**



Classe 100V16E

**THE VILLA
SOLUTION**



Classe 100V16B

**THE BUILDING
HANDS-FREE SOLUTION**



Classe 100V16M

**THE BUILDING
HANDSET SOLUTION**



Audio internal units

Classe 100A16E

**THE HANDSFREE
SOLUTION**



Classe 100A16M

**THE HANDSET
SOLUTION**





Classe 100 X16E
with Netatmo

Now the standard is connected

BTicino renews the range of **Classe 100** indoor units by introducing Wi-Fi connectivity in the standard video door entry system offer. The result is a range of video and audio indoor units with a modern and elegant design, capable of meeting all installation needs.



Built-in connectivity for constant connection with the home.

22
apt

Up to **22 apartments** without dedicated power supply.

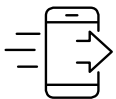

Immediate association with the **Home + Security App**.



Ideal for the refurbishment of old door entry systems.



No extra work for the installer; **easier to use** for the end user.



After being connected to **Classe 100X**, the smartphone becomes an “additional virtual video indoor unit” that can be used to answer calls, activate the opening of the door locks and activate the system cameras.



**Maximum freedom.
Always at ease, also
when away from the home.**

Thanks to the **built-in Wi-Fi connectivity**, Classe 100X gives the possibility of managing various functions quickly and safely using the smartphone.



**Full screen,
compact view.**

The **5" display** always ensures great visibility, irrespective of the type of installation.

Thin and minimal.

Modern design combined with **small thickness, lightness and solidity**: this is the characteristic design of the Classe 100.

Integration between physical and digital controls for better user experience.

New tilting control to answer and end the call, together with a range of touch controls for other functions.



App Functions



**Answer the call
comfortably from your
home sofa**

Absolute freedom of movement
inside your home.
You can answer the video door entry call
from any room of your home.



Answer all the calls from anywhere in the world

When you are out, on holiday, in the office, you can answer the video door entry call wherever you are.



Open the home gate

You return home by car and cannot find your gate radio control? No problem, you can open the gate with your smartphone.



Switch on the lights or water the garden

Even when you are out or on holiday, you can comfortably activate the garden watering and switch the lights on directly from your smartphone.



See what is happening outside the home

More security for your home. Using your smartphone you can activate the external and internal cameras connected to your video door entry system



Call home directly

Always keep in touch with anyone at home. The smartphone is an intercommunicating terminal with your video indoor unit.

Always aware with the Home + Security App



Home + Security

The best App for a safe home

Alerts and notifications for incoming calls, motion and people detection, event information and door lock management with a simple and intuitive interface.



Answer the calls,
activate the electrical door locks,
activate the cameras and display
the timeline of the events

Manage up to 20 homes
with your single account



Home + Security

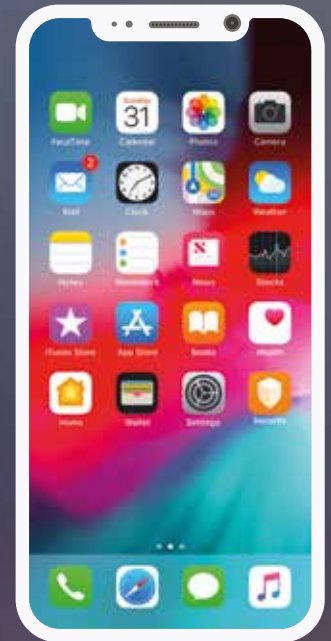

Incoming call

Receive notification
when someone
is calling

See who's calling

Answer the call and
open the gate for
the courier

Check the events

Check who called
you thanks to the
event timeline

Quick actions

- Activate the electrical door locks
- Activate the timed staircase lights
- Call home / Intercom
- Activate the cameras

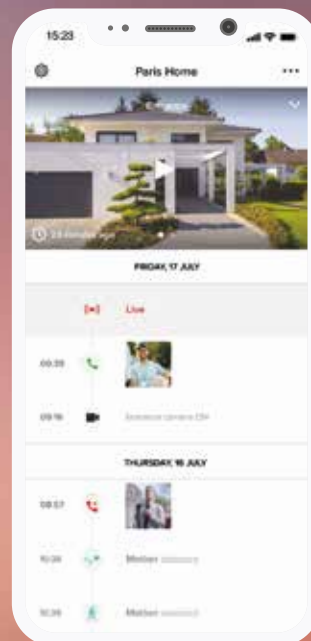
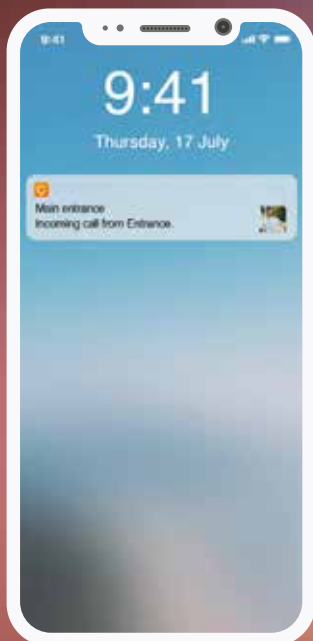

Security enhancement with integration of Netatmo devices

Video door entry system and security. Together.

Video door entry system



Main entrance
Incoming entrance call.

Security



Secondary entrance and interiors
Smart Outdoor Camera with Siren and movement detection. Smart Indoor Camera with face recognition.

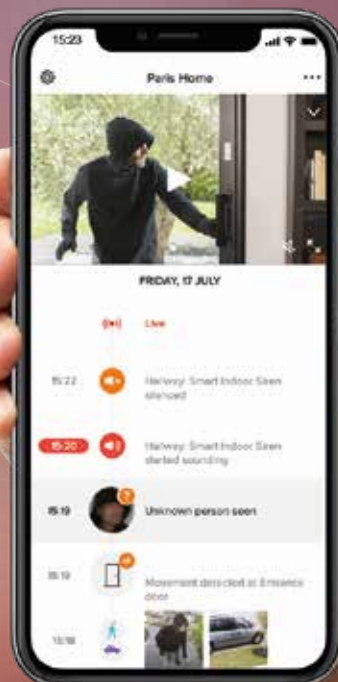

A single App with an intuitive home page. It allows you to answer video door entry calls, activate the door lock and view images from Netatmo smart outdoor and indoor cameras.



Professional opportunity: offer your services as an installer of simple smart security systems.
Business opportunities: access to a catalogue of smart and easy-to-install security devices.

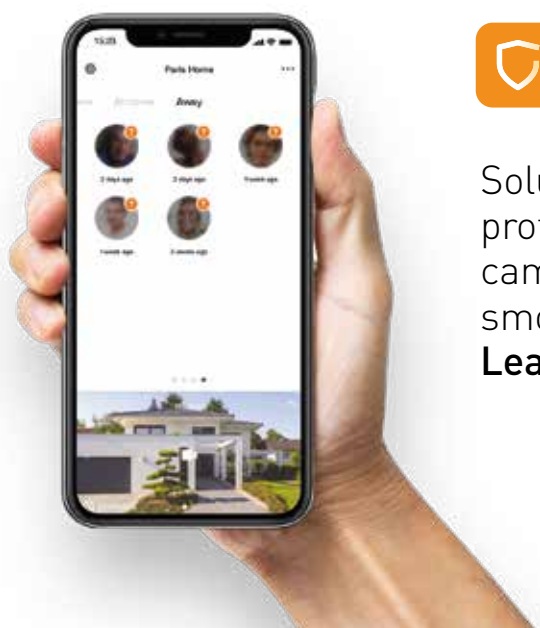

Home + Security
The best App for a safe home.

Solutions for a smart and complete protection of your home: security cameras, alarms, opening sensors, smoke detector...

Leave your home without worries.

WITH
Netatmo

Examples of Netatmo solutions natively integrated in the Home + Security app



Smart Outdoor Camera



Smart Outdoor Camera with Siren



Smart Indoor Camera



Smart Door and Window Sensors



Smart Video Doorbell



Smart Indoor Siren



Smart Smoke Alarm



Smart Carbon Monoxide Alarm

Perfect for renovations

In existing 2 WIRES systems you can update and replace your old indoor unit or video indoor unit with CLASSE 100X with Netatmo..
Thanks to the Wi-Fi connectivity you do not even need extra wiring.

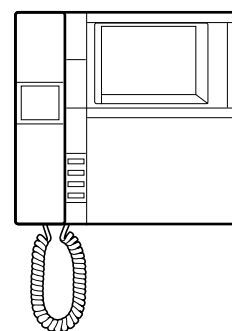
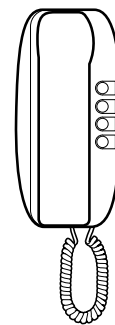

Classe 100X with Netatmo is the best solution available for renewing indoor unit

For the villa or for one&two-family context

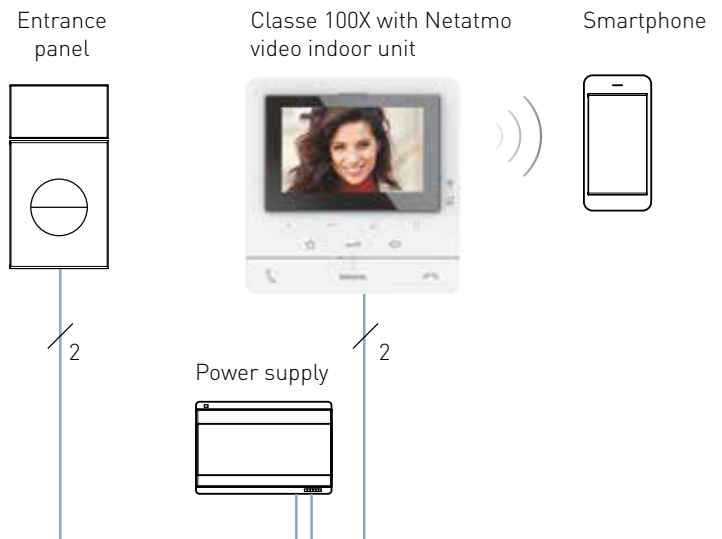

Built-in connectivity for constant connection with the home.

No extra work for the installer; **easier to use** for the end user.

For apartment block or multi-family context

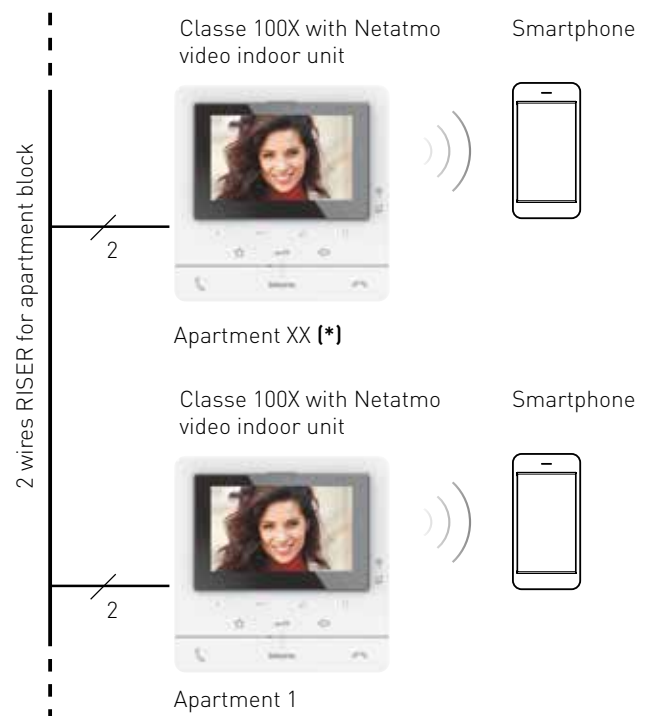

Built-in connectivity for constant connection with the home.

Up to **22 apartments** without dedicated power supply.

No extra work for the installer; **easier to use** for the end user.

[*] NOTE: for the sizing of multi-family systems refer to the General Installation Standards of the 2 Wires System Technical Guide.

Replacing the old BTicino video indoor unit with the connected **Classe 100** is simple and advantageous:

1 Remove the old 2 wires BTicino video indoor unit.

2 The new connected CLASSE 100 is installed **without the need for additional devices and/or wiring.** (Also in apartment complexes with up to 22 apartments).



COMPATIBLE DEVICES:

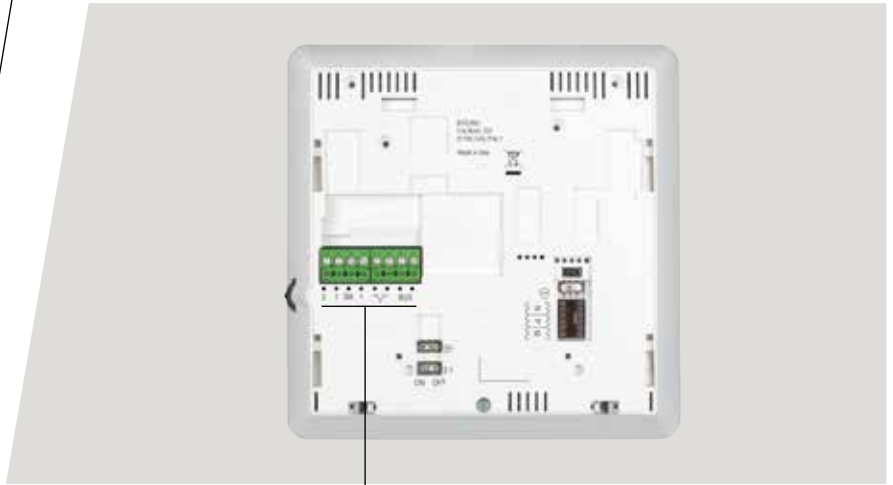
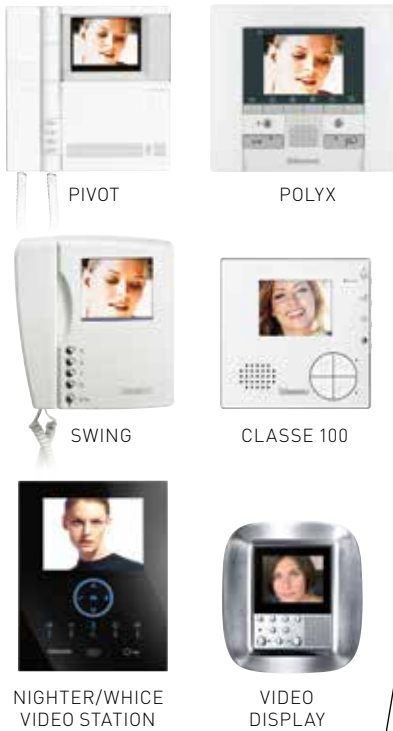

BTicino 2 wires video indoor units have standard plug-in SCS BUS clamps: **maximum simplicity.**

Aesthetic and functional upgrade

3 After installation, the new CONNECTED CLASSE 100 is associated to the Home + Security App, immediately making the **video door entry system functions** of your system available wherever you are **through your smartphone**.

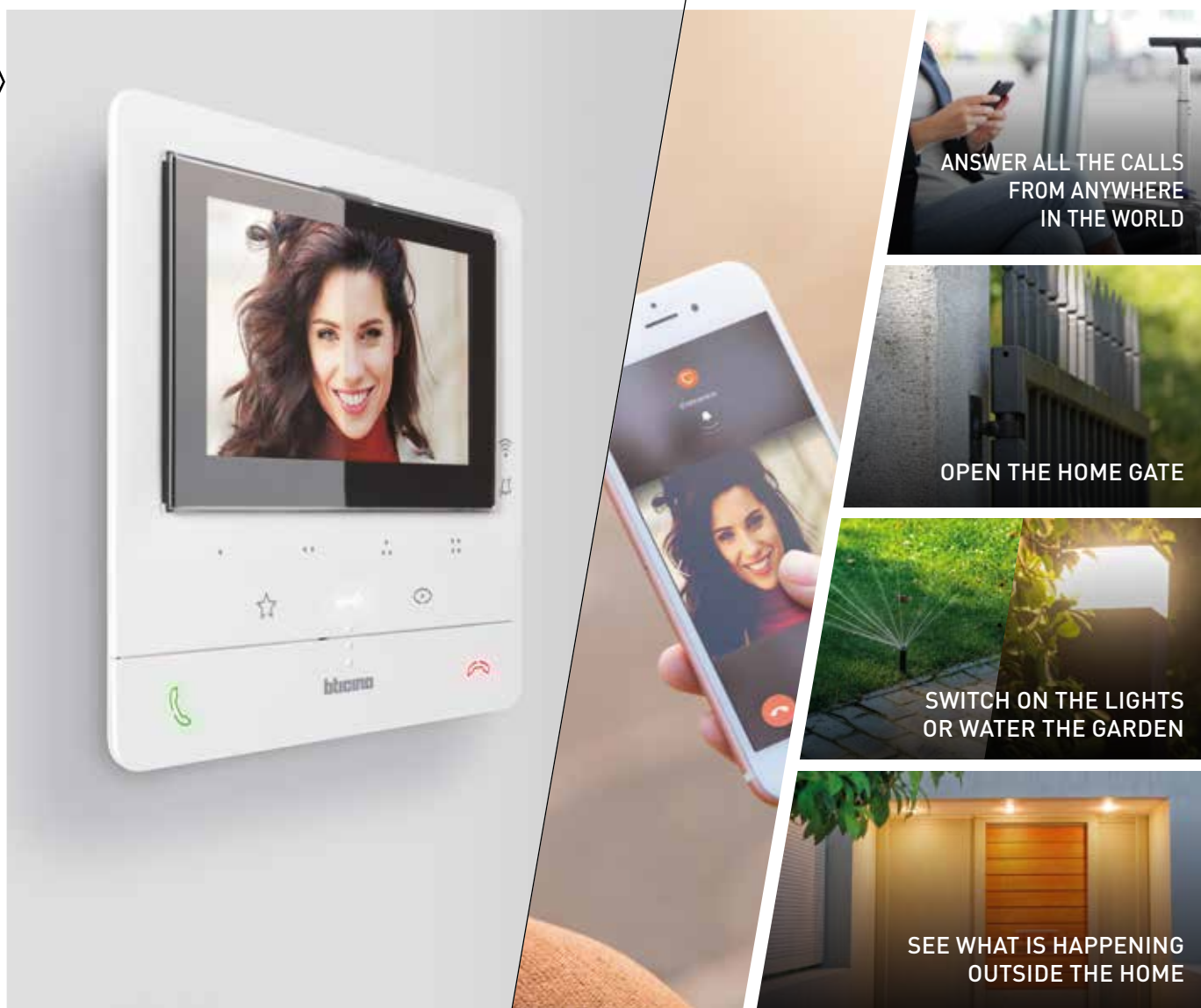

No extra work for the installer;
easier to use for the end user.



The Classe 100 range

From connected video version to audio version:
The range available is very wide, **for everyone and for all needs.**

Classe 100 X16E
with Netatmo



344682

The connected
solution for all

Classe 100
V16E



344672

The perfect villa solution that
ensures **maximum functional**
flexibility

Classe 100
V16B



344652

The hands-free solution for
multi dwelling buildings

Classe 100
V16M



344625

The handset solution for
multi dwelling buildings

Classe 100
A16E



344282

The handsfree
audio **solution**

Classe 100
A16M



344292

The **handset**
audio solution



Wall-mounted installation



Wall-mounted installation



Tabletop installation



Wall mounted installation (with the bracket supplied) and tabletop installation with support **344692 (to be purchased separately):**

VIDEO HANDS-FREE INDOOR UNITS

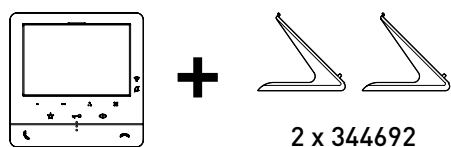



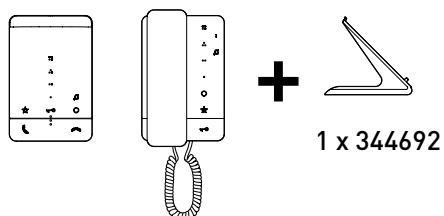

AUDIO INDOOR UNITS



CLASSE 100

Front view

Touch sensitive controls

-  Door lock activation
-  Entrance panel/camera scrolling activation
-  Staircase light activation
-  Customisable controls for the activation of accessory functions (e.g. intercom, activation of additional door lock, various activations)

LED notifications

-  Wi-Fi Connection
-  Ringtone exclusion

Physical control

Enable the handsfree communication

Physical control

Disable the handsfree communication



Tactile guide

Rear view

Plug-in connectors with screw clamps for connections

USB mini socket for firmware update

Adjustment and programming menu access and navigation joystick

ON / OFF micro switch to enable the Safe Door Lock function

Line termination ON/OFF micro-switch

Configurator socket

ON / OFF micro switch to enable the additional power supply

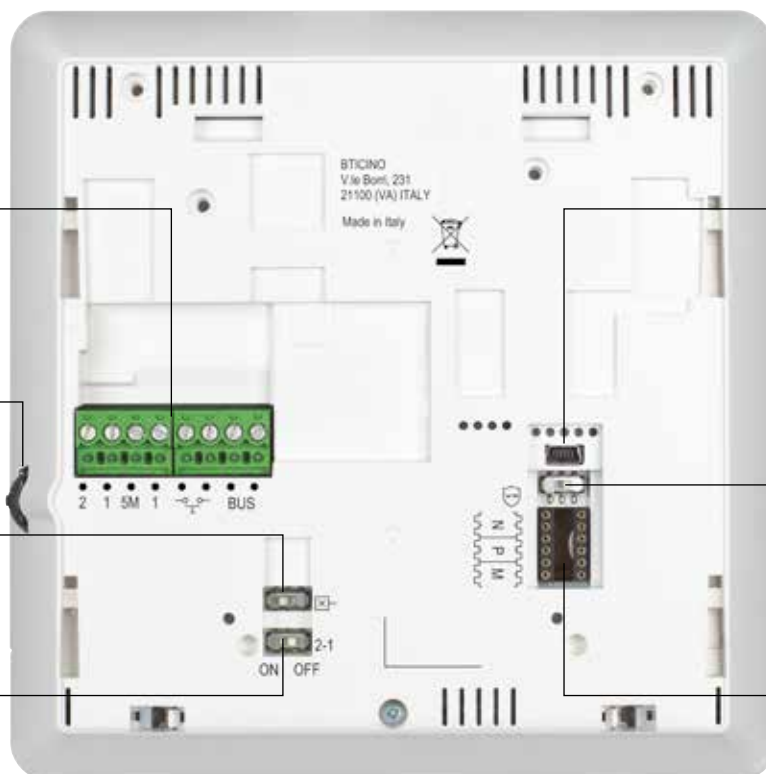

Features and functions

	Classe 100 X16E	Classe 100 V16E	Classe 100 V16B	Classe 100 V16M	Classe 100 A16E	Classe 100 A16M
						
	344682	344672	344652	344625	344282	344292

FEATURES

LCD colour display	5 inches	5 inches	5 inches	4.3 inches		
Handsfree	●	●	●		●	
Finish	white	white	white	white	white	white
Available in KIT	364614	364612	364613		364232	364231
Installation	wall / table	wall / table	wall / table	wall	wall / table	wall / table

AVAILABLE FUNCTIONS FROM AUDIO / VIDEO INDOOR UNIT

Door lock activation	●	●	●	●	●	●
Staircase light activation	●	●	●	●	●	●
EP / Scrolling activation	●	●	●	●	●	●
Intercom [1]	●	●	●	●	●	●
Inductive loop [2]	●	●				
Floor call	●	●	●	●	●	●
No. of configurable keys	4	4	1	1	4	4
No. of available ringtones	20	16	16	16	16	16
Professional Studio (Office)	●	●			●	●
Wi-Fi connectivity	●					

AVAILABLE FUNCTIONS FROM HOME + SECURITY APP

✓	Answer a video door entry system call
✓	Activation of the electrical door lock
✓	Entrance panel/scrolling activation
✓	Staircase light activation
✓	Activation and monitoring of the smart Netatmo cameras
✓	Management of the Netatmo Security devices (smoke sensor, burglar-alarm siren, opening sensor...)
✓	Intercom call from smartphone to video internal unit
✓	History of the events

1) Audio call, max. 3 minutes, between indoor units of the same apartment/different apartments
2) Use by people wearing hearing aids fitted with T selector

CLASSE 100

Catalogue



344682



344672



344652



344625



App Home + Security

Item	CLASSE 100X16E CONNECTED VIDEO INDOOR UNIT
344682	<p>Classe 100X16E with Netatmo 2 wires / Wifi handsfree connected video internal unit with inductive loop and 5" colour LCD display. It has 2 physical keys for the control of the main video door entry functions – answer and end a call – it has 3 touch keys for the control of the main functions – door lock release, staircase light control and entrance panel activation/scrolling – there are further 4 configurable touch keys that perform different functions – e.g. staircase light control, intercom, additional door lock activation, generic activations. The device has a side lever to adjust: colour, brightness and display contrast, audio volume, call tone volume and Wifi configuration. There are call exclusion notification LEDs and Wifi. Also, thanks to the Wifi connection, you can associate the video internal unit to the Home + Security App (available for Android and iOS). You can manage the main video internal unit functions (receiving calls, opening the door lock, activating the entrance panel/scrolling, FWR updating and additional activations) from the App. Through the Home + Security App it is also possible to manage the products of the Netatmo security offer (Outdoor and Indoor cameras, door and window sensors, internal siren and smoke detector). This allows you to quickly and easily create a Smart security system. The installation can be made to the wall using the bracket supplied or using table support accessories (2 x 344692) – to be purchased separately. The device, also equipped with the professional studio (office) function, must be configured.</p>

Item	CLASSE 100V16E VIDEO INDOOR UNIT
344672	<p>2 WIRES handsfree video indoor unit , with inductive loop and 5" colour LCD display It has 2 physical keys for the control of the main video door entry functions – answer and end a call – it has 3 touch keys for the control of the main functions – door lock release, staircase light control and entrance panel activation/scrolling – there are further 4 configurable touch keys that perform different functions – e.g. intercom, additional door lock activation, generic activations. The video indoor unit has a side lever to adjust: colour, brightness and display contrast, audio and call tone volume. There is a call exclusion notification LED. The installation can be made to the wall using the bracket (supplied) or using table support accessories (2 x 344692) – to be purchased separately. The device also has Professional Studio (Office) function and must be configured.</p>

Item	CLASSE 100V16B VIDEO INDOOR UNIT
344652	<p>2 WIRES handsfree video indoor unit with 5" colour LCD display. The device has 2 physical keys for the control of the main video door entry functions – answer and end a call – and 3 touch keys that allow the door lock release, the entrance panel activation/scrolling and the customisation of a most frequently used quick action – e.g. staircase light control, intercom, additional door lock activation, generic activations. The device has a side lever to adjust: colour, brightness and display contrast, audio and call tone volume. There is a call exclusion notification LED. The installation can be made to the wall using the bracket (supplied) or using table support accessories (2 x 344692) – to be purchased separately. The device must be configured.</p>

Item	CLASSE 100V16M VIDEO INDOOR UNIT
344625	<p>2 WIRES video indoor unit with handset and 4.3" colour LCD display, suitable for wall mounting installation (bracket support included). The device has three touch keys that allows : door lock release, entrance panel camera activation/scrolling and customization of an auxiliary function – e.g. additional door lock activation, additional camera activation. Side easily accessible and independent regulations for : call volume / ringtone exclusion (with notification LED), display colour and brightness. The handset has magnets for easy holding.</p>



344282



344292



344692



336803



336982



346020

Item	CLASSE 100A16E HANDSFREE AUDIO INDOOR UNIT
344282	<p>2 WIRES handsfree audio indoor unit for wall mounted or table installation.</p> <p>It has 2 physical keys for the control of the main functions – answer and end a call – and has 3 touch keys for the control of the main functions – door lock release, staircase light control and entrance panel activation/scrolling – there are further 4 configurable touch keys that perform different functions – e.g. intercom, additional door lock activation, generic activations. The device has a side lever to adjust the audio volume and call tone and a call exclusion notification LED. The installation can be made to the wall using the bracket (supplied) or using table support accessory (1 x 344692) – to be purchased separately. The device also has Professional Studio (Office) function and must be configured.</p>

Item	CLASSE 100A16M AUDIO INDOOR UNIT WITH HANDSET
344292	<p>2 WIRES audio indoor unit with handset for wall mounted or table installation. It has 3 touch keys for the control of the main functions – door lock release, staircase light control and entrance panel activation/scrolling – there are further 4 configurable touch keys that perform different functions – e.g. intercom, additional door lock activation, generic activations. Ringtone volume adjustment (with call exclusion) using the appropriate selector. The installation can be made to the wall using the bracket (supplied) or using table support accessory (1 x 344692) – to be purchased separately. The device also has Professional Studio (Office) function and must be configured.</p>

Item	ACCESSORIES - TABLE SUPPORT - CABLE - SOCKETS
344692	Table support accessory for CLASSE 100 audio and video hands-free indoor units.
336803	8-way cable with connector for tabletop support connection.
336982	<p>White Livinglight series 8-pole plug for the connection of the 336803 cable in tabletop installations.</p> <p>The socket is available also in the following finishings:</p> <ul style="list-style-type: none"> - LIVINGLIGHT (336983 - 336984); - AXOLUTE (349414 - 349415 - 349418); - MATIX (336985).

Item	2 DIN ADDITIONAL POWER SUPPLY
346020	Additional 2 DIN power supply to be used for the local power supply to connected CLASSE 100x16E (344682) video indoor units in multi-family systems in complexes with more than 22 apartments.

CLASSE 100

Video KIT

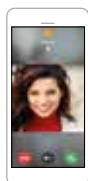

H + S



364614



364612

Item **CLASSE 100X16E - LINEA 3000 CONNECTED VIDEO KIT**

364614 One-family handsfree kit with: Classe 100X16E with Netatmo Wifi video internal unit, handsfree function, inductive loop, 5" LCD display; LINEA 3000 pushbutton panel with zamak front cover, wide angle colour camera, proximity reader and with a set of coloured key cards and two clear discs for door lock release. Can be configured for one-family and two-family installations. It can manage a maximum of 20 key cards (125 KHz) for the electric door lock release (including the one for the system management). Nameplate lit by white LED. Can be wall or flush installed with specific accessories: (350020) flush mounted box and (343061) flush mounted accessory - to be purchased separately. Can be fitted with rainshield (343051)- to be purchased separately. The pushbutton panel has a protection index IP54- protection index against mechanical impact IK10. The video internal unit has 4.3" colour LCD display and Inductive Loop function (to enable use by people wearing hearing aids fitted with T selector). It also has 3 touch keys for the control of the main functions – door lock release, staircase light control and entrance panel activation/scrolling – there are further 4 configurable touch keys that perform different functions – e.g. staircase light control, intercom, additional door lock activation, generic activations. It has a side lever to adjust: colour, brightness and display contrast, audio volume, call tone volume and Wi-Fi configuration. There are call exclusion notification LEDs and Wifi. Also, thanks to the Wifi connection, you can associate the video internal unit to the Home + Security App (available for Android and iOS). You can manage the main video internal unit functions (receiving calls, opening the door lock, activating the entrance panel/scrolling, Firmware updating and additional activations) from the App. Through the Home + Security App it is also possible to manage the products of Netatmo security offer (Outdoor and Indoor cameras, door and window sensors, internal siren and smoke detector). This allows you to quickly and easily create a Smart security system. The installation can be made to the wall using the bracket supplied or using table support accessories (2 x 344692) – to be purchased separately. The device, also equipped with the professional studio (office) function, must be configured.

Item **CLASSE 100V16E - LINEA 3000 VIDEO KIT**

364612 One-family handsfree kit with CLASSE 100V16E video indoor unit and LINEA 3000 pushbutton panel with zamak front cover and wide angle colour camera. Can be configured for one-family or two-family installations. Nameplate lit by white LED. Can be wall or flush installed with specific accessories: (350020) flush mounted box with (343061) flush mounted accessory - to be purchased separately. Can be fitted with rainshield (343051) – to be purchased separately. The pushbutton panel has a protection index IP54 - protection index against mechanical impact IK10. The video indoor unit has 5" LCD display and Inductive Loop function (to enable use by people wearing hearing aids fitted with T selector). It has 2 physical keys for the control of the main functions – answer and end a call – and has 3 touch keys for the control of the main functions – door lock release, staircase light control and entrance panel activation/scrolling – there are further 4 configurable touch keys that perform different functions – e.g. intercom, additional door lock activation, generic activations. Wall mounted installation with the bracket supplied or table installation with support accessories (2 x 344692) - to be purchased separately. The device also has Professional Studio (Office) function and must be configured.



364613

Item **CLASSE 100V16B - LINEA 2000 ONE-FAMILY BASIC VIDEO KIT**

364613 One-family handsfree video kit consisting of: CLASSE 100V16B video indoor unit, LINEA 2000 pushbutton panel with colour camera and 1 call pushbutton. The push-button panel has a protection index against mechanical impact IK07 and protection index IP54. The video indoor unit has 2 physical keys for the control of the main video door entry functions – answer and end a call – and 3 touch keys that allow the door lock release, the entrance panel activation/scrolling and the customisation of a most frequently used quick action – e.g. staircase light control, intercom, additional door lock activation, generic activations. The video indoor unit has a 5" colour LCD display and a side lever to adjust: colour, brightness and display contrast, audio and call tone volume. There is a call exclusion notification LED. Wall mounted installation with the bracket supplied or table installation with support accessories (2 x 344692) - to be purchased separately.



CLASSE 100

Audio KIT



364232



364231

Item	CLASSE 100A16E - LINEA 3000 HANDSFREE AUDIO KIT
364232	<p>One-family handsfree kit with CLASSE 100A16E audio indoor unit and LINEA 3000 pushbutton panel with zamak front cover. Can be configured for one-family or two-family installations. Nameplate lit by white LED. Can be wall or flush installed with specific accessories: (350020) flush mounted box with (343061) flush mounted accessory - to be purchased separately. Can be fitted with rainshield (343051) – to be purchased separately.</p> <p>The pushbutton panel has a protection index IP54 - protection index against mechanical impact IK10. The indoor unit has 2 physical keys for the control of the main door entry functions – answer and end a call – and has 3 touch keys for the control of the main functions – door lock release, staircase light control and entrance panel activation/scrolling – there are further 4 configurable touch keys that perform different functions – e.g. intercom, additional door lock activation, generic activations. Ringtone volume adjustment (with call exclusion) using the appropriate selector.</p> <p>The installation can be made to the wall using the bracket supplied or using table support accessory (1 x 344692) – to be purchased separately. The device also has Professional Studio (Office) function and must be configured.</p>

Item	CLASSE 100A16M - LINEA 3000 AUDIO KIT WITH HANDSET
364231	<p>One-family audio kit with CLASSE 100A16M audio indoor unit and LINEA 3000 pushbutton panel with zamak front cover. Can be configured for one-family or two-family installations. Nameplate lit by white LED. Can be wall or flush installed with specific accessories: (350020) flush mounted box with (343061) flush mounted accessory – to be purchased separately. Can be fitted with rainshield (343051) – to be purchased separately.</p> <p>The pushbutton panel has a protection index IP54 - protection index against mechanical impact IK10. The audio indoor unit has 3 touch keys for the control of the main functions – door lock release, staircase light control and entrance panel activation/scrolling – there are further 4 configurable touch keys that perform different functions – e.g. intercom, additional door lock activation, generic activations. Ringtone volume adjustment (with call exclusion) using the appropriate selector.</p> <p>The installation can be made to the wall using the bracket supplied or using table support accessory (1 x 344692) – to be purchased separately. The device also has Professional Studio (Office) function and must be configured.</p>

Netatmo safety devices

Catalogue



Home + Security App



NOC - PRO



NOC -S- PRO



NOC-S-W-PRO



NSC - PRO



NBU - AS - PRO



DTG - PRO

Item SMART OUTDOOR CAMERA

NOC-PRO Smart outdoor safety camera with detection of people, animals and vehicles. Aluminium single monobloc construction. Ultra-resistant glass and plastic, protection against UV rays. Video sensor: 4MP. Resolution: Full HD 1080 p. Coding: H.264. Long-range detection: up to 20 m. Field of view: 100°. 8x digital zoon for videos. Video live microphone. LED spotlight: 12 W, variable intensity. Infrared night vision: 15 m. Encryption protected access to the smartphone using the Home + Security App. Weather resistant: designed for outdoor use (HZO protection).

Item SMART INDOOR CAMERA

NSC-PRO Smart indoor safety camera with people detection consisting of an aluminium monobloc unit. Video sensor: 4MP. 130° panoramic view for a wider coverage. High quality video with Full HD 1080 p viewing. Guaranteed day and night protection with infrared vision, for comfortable viewing even in total darkness. Recording only in case of intrusion, in respect of the privacy of the family. Encryption protected access to the smartphone using the Home + Security App. Declaration of conformity and FCC declarations. Open-source compatibility. It has to be connected to an electric socket with the supplied AC adapter.

SMART OUTDOOR CAMERA WITH SIREN

NOC-S-PRO Smart outdoor safety camera with detection of people, animals and vehicles. Equipped with 105 db alarm siren. Aluminium single monobloc construction. Ultra-resistant glass and plastic, protection against UV rays. Video sensor: 4MP. Resolution: Full HD 1080 p. Coding: H.264. Long-range detection: up to 20 m. Field of view: 100°. 8x digital zoon for videos. Video live microphone. LED spotlight: 12 W, variable intensity. Infrared night vision: 15 m. Encryption protected access to the smartphone using the Home + Security App. Weather resistant: designed for outdoor use (HZO protection).

SMART VIDEO ALARM SYSTEM

NBU-AS-PRO Smart video security alarm system consisting of 1 smart indoor camera, 1 smart indoor siren and 3 smart door and window opening sensors. The products can be easily configured and associated using the Home + Security app. The smart video alarm system activates and deactivates automatically, has pre-recorded sounds to simulate a presence in the home, respects the privacy of the family and activates a 110 dB sound in case of intrusion.

NOC-S-W-PRO Features like NOC-S-PRO. White finish.

SMART DOOR AND WINDOW SENSORS

DTG-PRO Smart opening sensors for doors and windows ideal for safety. Sensors with waterproof monobloc construction, vibration/motion detection and open/closed status. Power supply with 2 AAA-type batteries included in the package. They only work with the smart indoor camera (sold separately): radio link between the sensors and the camera. Declaration of conformity and FCC. Open-source compatibility. Can be controlled and managed remotely with Home + Security app.

Netatmo safety devices

Catalogue



NDB - PRO



NSA - PRO - EU



NIS - 01 - PRO



NCO - PRO

Item	SMART VIDEO DOORBELL
NDB-PRO	Smart video doorbell for outdoor installation. Allows you to receive a video call on your smartphone when someone rings the doorbell. Equipped with Camera: 2 megapixels, 5x digital zoom. HDR function of automatic adaptation to lighting conditions. Infrared night vision even in conditions of total absence of brightness. Video: Full HD 1080 p, portrait format 9:16. Field of view: 140° diagonal. Sound: high-quality speaker and microphone. Night vision: Infrared LED. Operating temperature: -10° to 40° C. Weather resistant: H2O protection and IP44 certification. Power supply: 8-24 VAC & 230 VAC; minimum 8 VA. Local storage on microSD memory card and optional storage on Dropbox or FTP server MicroSD card up to 32 GB (class 10). Data protection with encrypted connection for the highest level of privacy. Requirements: high speed internet access. The minimum required upload and download speed is 25 KB/s. Hotspots are not supported. Wireless specifications: Wi-Fi 802.11 b/g/n (2.4 GHz), Open/WEP/WPA/WPA2-personal. Operation via Home + Security app (iOS 10 required minimum - Android 5.0 required minimum). Compatible with Apple HomeKit, Google Assistant and Amazon Alexa. www.netatmo.com

Item	SMART SMOKE ALARM
NSA-PRO-EU	Smart Smoke Alarm with 85 dB alarm, high performance photoelectric sensor, average coverage 50 m ² . When it detects the presence of smoke, it activates its 85-decibel alarm and immediately alerts you to your smartphone. It is equipped with a 10-year battery - the maximum lifetime for all smoke detectors. The Self-Test feature checks if the Smart Smoke Alarm is functioning correctly. If it detects a problem, it sends a notification to your smartphone. Reliability guaranteed by CE (EN 14604) and NF certifications. Standalone device, no hub required. Compatible with Apple HomeKit. Operation via the Home + Security app. Requirements: High-speed wireless internet connection needed. Public hotspots not supported. The Smart Smoke Alarm will detect smoke and will sound even if the Wi-Fi isn't configured. However, you will need Wi-Fi to receive smartphone alerts. Wi-Fi 802.11 b/g/n (2.4 GHz), Open/WEP/WPA/WPA2-Personal, Bluetooth Low Energy (BLE).

Item	SMART INDOOR SIREN
NIS-01-PRO	Smart indoor siren with 110 dB alarm, pre-recorded sounds and vibration sensor for tamper detection. Battery power supply or with a cable (not supplied) using the USB micro port. It only works with the smart indoor camera and must be installed in the same room: Bluetooth Low Energy (BLE) wireless connection with the smart indoor camera. Declaration of conformity and FCC declarations. Open-source compatibility. Operation using the Home + Security app.

Item	SMART CARBON MONOXIDE ALARM
NCO-PRO	Smart carbon monoxide alarm / detector for wall installation. It allows to monitor the fuel-burning appliances (boiler, fireplace, wood-burning stove, gas cooker, etc.) by measuring, in real time, the levels of carbon monoxide, which is an invisible, odourless and potentially fatal gas. When it detects the presence of carbon monoxide, it activates its 85-decibel alarm and immediately alerts you to your smartphone. It is equipped with a 10-year battery - the maximum lifetime for all carbon monoxide detectors. The Self-Test feature checks if the Smart Carbon Monoxide Alarm is functioning correctly. If it detects a problem, it sends a notification to your smartphone. Reliability guaranteed by CE (EN 50291) and NF certifications. Standalone device, no hub required. Compatible with Apple HomeKit. Operation via the Home + Security app. Requirements: High-speed wireless internet connection needed. Public hotspots not supported. The Smart Carbon Monoxide Alarm will detect Carbon Monoxide and will sound even if the Wi-Fi isn't configured. However, you will need Wi-Fi to receive smartphone alerts. Wi-Fi 802.11 b/g/n (2.4 GHz), Open/WEP/WPA/WPA2-Personal, Bluetooth Low Energy (BLE).

Dimensional data

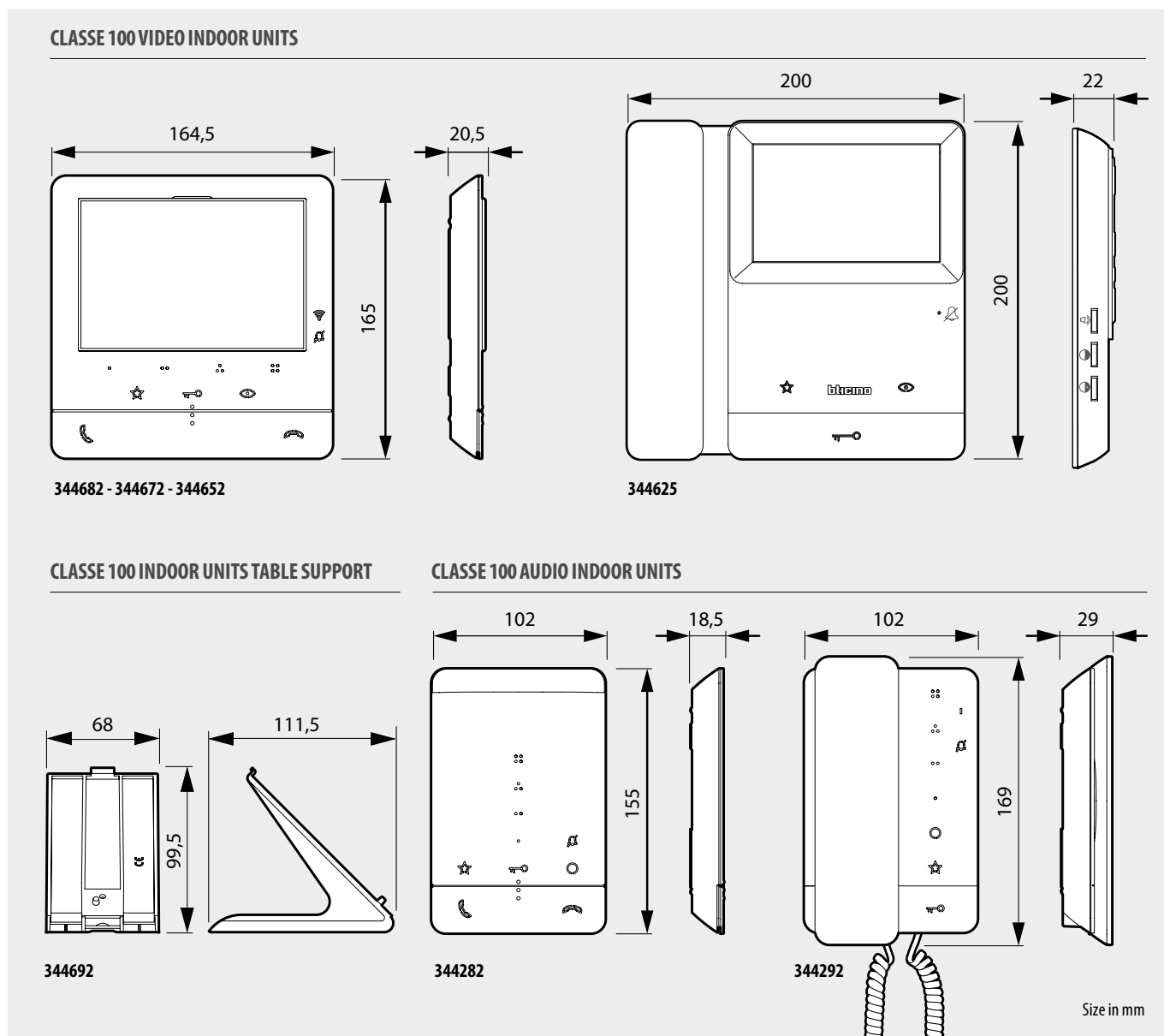

CLASSE 100X16E with Netatmo

Legal notes

To use the video door entry call repeat service on a smartphone, the customer must acquire the technical equipment which allows access to the Internet, on the basis of an agreement made by the customer himself with an ISP (Internet Service Provider). BTicino plays no part in this. The customer must install the Home + Security App on his smartphone so that he can use some services which BTicino supplies as extras to the normal basic functions of the CLASSE 100X16E with Netatmo video indoor unit. The services offered by means of the App require being able to interact with CLASSE 100X16E with Netatmo remotely and through the Internet.

In these cases the integration and good working between CLASSE 100X16E with Netatmo and App may depend on:

- quality of the Wi-Fi signal;
- type of access contract to the home internet;
- type of data contract on the smartphone

When one of these 3 elements does not conform with the specifications required for product operation, BTicino accepts no responsibility for any faults. The product supports a VoIP streaming system. You must therefore check with your smartphone contract – data network – that it does not block it. We should also like to inform you that the service provided by BTicino – remote use via App – involves the use of data. The cost linked to data usage depends on the type of contract which the customer has with his ISP (Internet Service Provider) and is solely the customer's responsibility.

NOTES

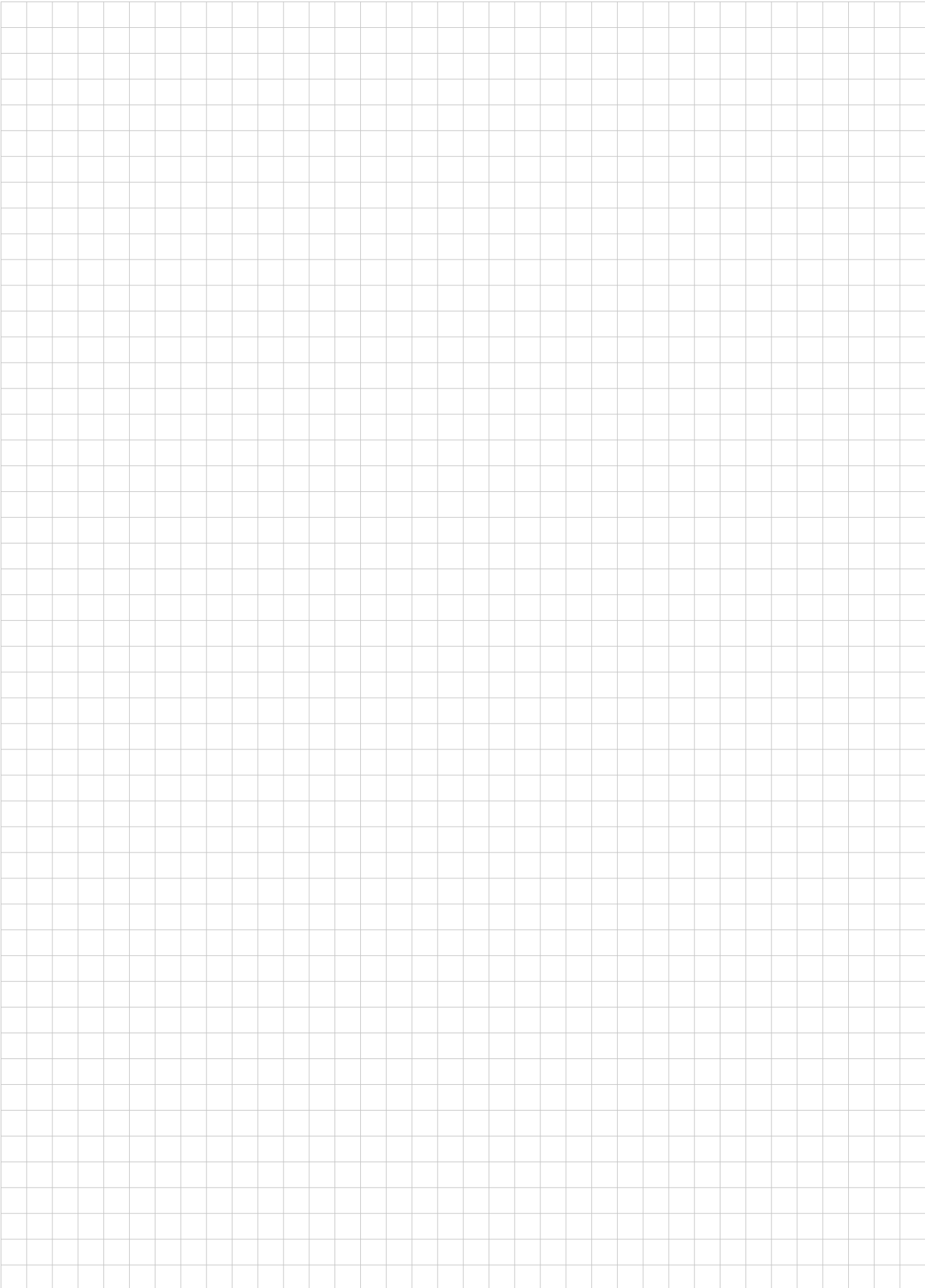



BTicino SpA
Viale Borri, 231
21100 Varese - Italy
www.bticino.com

AD-EXCM100PI/23C/ENG - Version 06/2023